

GV  
1001  
.S75

1919

9

R. LINDLEY  
MURRAY  
National  
Singles  
Champion  
1918

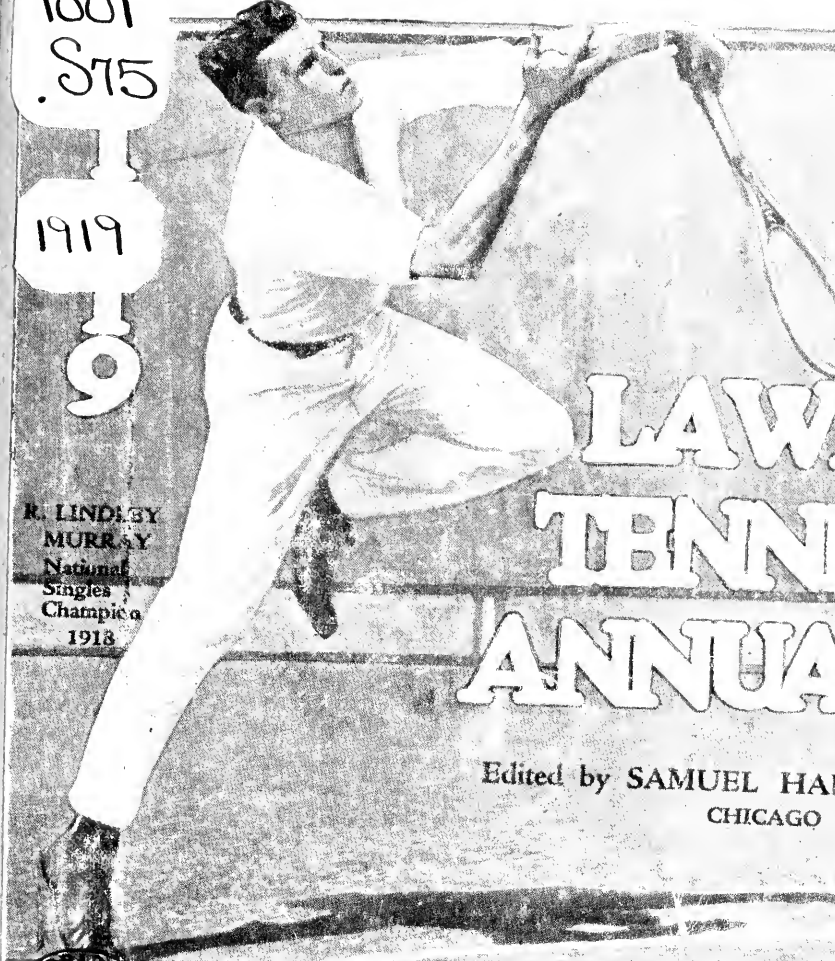

LAWY  
TENNIS  
ANNUAL

Edited by SAMUEL HARRIS  
CHICAGO





Class \_\_\_\_\_

Book: \_\_\_\_\_

Copyright N<sup>o</sup> \_\_\_\_\_

**COPYRIGHT DEPOSIT.**

# SPALDING ATHLETIC LIBRARY

## SPALDING OFFICIAL ANNUALS

- No. 1. SPALDING'S OFFICIAL BASE BALL GUIDE. . . . . Price 10c.  
No. 1S. SPALDING'S OFFICIAL BASE BALL GUIDE. (Spanish Edition) . . . . . Price 10c.  
No. 2. SPALDING'S OFFICIAL FOOT BALL GUIDE. . . . . Price 10c.  
No. 6. SPALDING'S OFFICIAL ICE HOCKEY GUIDE. . . . . Price 10c.  
No. 7. SPALDING'S OFFICIAL BASKET BALL GUIDE. . . . . Price 10c.  
No. 7A. SPALDING'S OFFICIAL WOMEN'S BASKET BALL GUIDE. . . . . Price 10c.  
No. 9. SPALDING'S OFFICIAL INDOOR BASE BALL GUIDE. . . . . Price 10c.  
No. 12A. SPALDING'S OFFICIAL ATHLETIC RULES. . . . . Price 10c.  
No. 1R. SPALDING'S OFFICIAL ATHLETIC ALMANAC. . . . . Price 25c.  
No. 3R. SPALDING'S OFFICIAL GOLF GUIDE. . . . . Price 25c.  
No. 55R. SPALDING'S OFFICIAL SOCCER FOOT BALL GUIDE. . . . . Price 25c.  
No. 57R. SPALDING'S LAWN TENNIS ANNUAL. . . . . Price 25c.  
No. 59R. SPALDING'S OFFICIAL BASE BALL RECORD. . . . . Price 25c.

### Specially Bound Series of Athletic Handbooks

Flexible binding. Mailed postpaid on receipt of 50 cents each number.

- No. 501L. STROKES AND SCIENCE OF LAWN TENNIS  
No. 502L. HOW TO PLAY GOLF  
No. 503L. HOW TO PLAY FOOT BALL  
No. 504L. ART OF SKATING  
No. 505L. GET WELL—KEEP WELL  
No. 506L. HOW TO LIVE 100 YEARS  
No. 507L. HOW TO WRESTLE  
No. 508L. HOW TO PLAY LAWN TENNIS; HOW TO PLAY  
TENNIS FOR BEGINNERS  
No. 509L. BOXING  
No. 510L. DUMB BELL EXERCISES  
No. 511L. JIU JITSU  
No. 512L. SPEED SWIMMING  
No. 513L. WINTER SPORTS  
No. 514L. HOW TO BOWL  
No. 515L. HOW TO SWIM AND COMPETITIVE DIVING.  
No. 516L. SCHOOL TACTICS AND MAZE RUNNING; CHILDREN'S GAMES.  
No. 517L. TEN AND TWENTY MINUTE EXERCISES  
No. 518L. INDOOR AND OUTDOOR GYMNASTIC GAMES  
No. 519L. SPALDING'S OFFICIAL BASE BALL GUIDE  
No. 520L. SPALDING'S OFFICIAL FOOT BALL GUIDE  
No. 521L. SPALDING'S OFFICIAL BASKET BALL GUIDE  
No. 522L. GOLF FOR GIRLS  
No. 523L. HOW TO PLAY BASE BALL; HOW TO MANAGE  
A TEAM, ETC.  
No. 524L. SPALDING'S LAWN TENNIS ANNUAL  
No. 525L. HOW TO PITCH; READY RECKONER OF BASE  
BALL PERCENTAGES  
No. 526L. HOW TO CATCH; HOW TO BAT

In addition to above, any 25 cent "Red Cover" book listed in Spalding's Athletic Library will be bound in flexible binding for 50 cents each; or any two 10 cent "Green Cover" or "Blue Cover" books in one volume for 50 cents.

(Continued on the next page.)

---

ANY OF THE ABOVE BOOKS MAILED POSTPAID UPON RECEIPT OF PRICE

# SPALDING ATHLETIC LIBRARY

## Group I.

## Base Ball

- "Blue Cover" Series, each number 10c.*  
 No. 1 Spalding's Official Base Ball Guide  
 No. 1S Spalding's Official Base Ball Guide. Spanish Edition.  
 No. 202 How to Play Base Ball  
 No. 219 Ready Reckoner of Base Ball  
 No. 223 How to Bat [Percentages  
 No. 224 How to Play the Outfield  
 No. 225 How to Play First Base  
 No. 226 How to Play Second Base  
 No. 227 How to Play Third Base  
 No. 228 How to Play Shortstop  
 No. 229 How to Catch  
 No. 230 How to Pitch  
 How to Organize a Base Ball League [Club  
 How to Organize a Base Ball Club  
 How to Manage a Base Ball Club  
 No. 231 How to Train a Base Ball Team  
 How to Captain a Team  
 Technical Base Ball Terms  
 No. 232 How to Run Bases  
 No. 350 How to Score  
 No. 355 Minor League Base Ball Guide  
 No. 356 Official Book National League  
 No. 9 Spalding's Official Indoor Base Ball Guide

- "Red Cover" Series, each number 25c.*  
 No. 59R. Official Base Ball Record  
 No. 75R. How to Umpire

## Group II.

## Foot Ball

- "Blue Cover" Series, each number 10c.*  
 No. 2 Spalding's Official Foot Ball Guide  
 No. 353 Official College Soccer Guide  
*"Red Cover" Series, each number 25c.*  
 No. 39R. How to Play Soccer  
 No. 47R. How to Play Foot Ball  
 No. 55R. Spalding's Official Soccer

## Group III.

## Tennis

- "Blue Cover" Series, each number 10c.*  
 No. 157 How to Play Lawn Tennis  
 No. 363 Tennis Errors and Remedies  
*"Green Cover" Series, each number 10c.*  
 No. 1P. How to Play Tennis—For Beginners. By P. A. Vaile  
*"Red Cover" Series, each number 25c.*  
 No. 2R. Strokes and Science of Lawn Tennis  
 No. 26R. Official Handbook National Squash Tennis Association  
 No. 42R. Davis Cup Contests in Australasia  
 No. 57R. Spalding's Lawn Tennis Annual

## Group IV.

## Golf

- "Green Cover" Series, each number 10c.*  
 No. 2P. How to Learn Golf  
*"Red Cover" Series, each number 25c.*  
 No. 3R. Spalding's Official Golf  
 No. 4R. How to Play Golf [Guide  
 No. 63R. Golf for Girls

## Group V.

## Basket Ball

- "Blue Cover" Series, each number 10c.*  
 No. 7 Spalding's Official Basket Ball Guide  
 No. 7A Spalding's Official Women's Basket Ball Guide  
 No. 193 How to Play Basket Ball

## Group VI. Skating and Winter Sports

- "Blue Cover" Series, each number 10c.*  
 No. 6 Spalding's Official Ice Hockey  
 No. 14 Curling [Guide  
*"Red Cover" Series, each number 25c.*  
 No. 8R. The Art of Skating  
 No. 20R. How to Play Ice Hockey  
 No. 28R. Winter Sports  
 No. 72R. Figure Skating for Women

## Group VII. Field and Track Athletics

- "Blue Cover" Series, each number 10c.*  
 No. 12A Spalding's Official Athletic Rules  
 No. 27 College Athletics  
 No. 55 Official Sporting Rules  
 No. 87 Athletic Primer  
 No. 156 Athletes' Guide  
 No. 178 How to Train for Bicycling  
 No. 182 All Around Athletics  
 No. 255 How to Run 100 Yards  
 No. 302 Y. M. C. A. Official Handbook  
 No. 317 Marathon Running  
 No. 342 Walking for Health and Competition  
 No. 362 Track, Relay and Cross Country Rules of the National Collegiate Athletic Ass'n.  
*"Green Cover" Series, each number 10c.*  
 No. 3P. How to Become an Athlete By James E. Sullivan  
 No. 4P. How to Sprint  
*"Red Cover" Series, each number 25c.*  
 No. 1R. Spalding's Official Athletic Almanac  
 No. 17R. Olympic Games, Stockholm, 1912 [book  
 No. 45R. Intercollegiate Official Hand-  
 No. 48R. Distance and Cross Country Running  
 No. 70R. How to Become a Weight Thrower

(Continued on the next page.)

ANY OF THE ABOVE BOOKS MAILED POSTPAID UPON RECEIPT OF PRICE



# SPALDING ATHLETIC LIBRARY

## Group VIII. School Athletics

- "Blue Cover" Series, each number 10c.*  
No. 246 Athletic Training for School-boys  
*"Red Cover" Series, each number 25c.*  
No. 61R. School Tactics and Maze Running; Children's Games  
No. 66R. Calisthenic Drills and Fancy Marching and Physical Training for the School and Class Room  
No. 71R. Public Schools Athletic League Official Handbook  
No. 74R. Schoolyard Athletics

## Group IX. Water Sports

- "Blue Cover" Series, each number 10c.*  
No. 128 How to Row  
No. 129 Water Polo [Guide  
No. 361 Intercollegiate Swimming  
*"Red Cover" Series, each number 25c.*  
No. 36R. Speed Swimming  
No. 37R. How to Swim  
No. 60R. Canoeing and Camping

## Group X. Athletic Games for Women and Girls

- "Blue Cover" Series, each number 10c.*  
No. 7A Spalding's Official Women's Basket Ball Guide  
*"Blue Cover" Series, each number 25c.*  
No. 314 Girls' Athletics  
*"Red Cover" Series, each number 25c.*  
No. 38R. Field Hockey  
No. 41R. Newcomb  
No. 63R. Golf for Girls  
No. 69R. Girls and Athletics

## Group XI. Lawn and Field Games

- "Blue Cover" Series, each number 10c.*  
No. 167 Quoits  
No. 170 Push Ball  
No. 180 Ring Hockey  
No. 199 Equestrian Polo  
No. 201 How to Play Lacrosse  
No. 207 Lawn Bowls  
*"Red Cover" Series, each number, 25c.*  
No. 6R. Cricket, and How to Play It  
No. 43R. Archery, Roque, Croquet, English Croquet, Lawn Hockey, Tether Ball, Clock Golf, Golf-Croquet, Hand Tennis, Hand Polo, Wicket Polo, Badminton, Drawing Room Hockey, Garden Hockey, Basket Goal, Volley Ball Rules and Pin Ball

## Group XII. Miscellaneous Games

- "Blue Cover" Series, each number 10c.*  
No. 13 American Game of Hand Ball  
No. 364 Volley Ball  
*"Red Cover" Series, each number 25c.*  
No. 49R. How to Bowl  
No. 50R. Court Games

## Group XIII. Manly Sports

- "Blue Cover" Series, each number 10c.*  
No. 191 How to Punch the Bag  
No. 282 Roller Skating Guide  
*"Red Cover" Series, each number 25c.*  
No. 11R. Fencing Foil Work Illustrat-  
No. 19R. Professional Wrestling [ed  
No. 21R. Jiu Jitsu  
No. 25R. Boxing  
No. 30R. The Art of Fencing  
No. 65R. How to Wrestle

## Group XIV. Calisthenics

- "Red Cover" Series, each number 25c.*  
No. 10R. Single Stick Drill  
No. 16R. Team Wand Drill  
No. 22R. Indian Clubs and Dumb Bells and Pulley Weights  
No. 24R. Dumb Bell Exercises  
No. 73R. Graded Calisthenics and Dumb Bell Drills

## Group XV. Gymnastics

- "Blue Cover" Series, each number 10c.*  
No. 124 How to Become a Gymnast  
No. 254 Barnjum Bar Bell Drill  
No. 287 Fancy Dumb Bell and Marching Drills  
*"Red Cover" Series, each number 25c.*  
No. 14R. Trapeze, Long Horse and Rope Exercises  
No. 34R. Grading of Gym. Exercises  
No. 40R. Indoor and Outdoor Gymnastic Games  
No. 52R. Pyramid Building  
No. 56R. Tumbling for Amateurs and Ground Tumbling  
No. 67R. Exercises on the Side Horse; Exercises on the Flying Rings.  
No. 68R. Horizontal Bar Exercises; Exercises on Parallel Bars

## Group XVI. Home Exercising

- "Blue Cover" Series, each number 10c.*  
No. 161 Ten Minutes' Exercise for  
No. 185 Hints on Health [Busy Men  
No. 325 Twenty-Minute Exercises  
*"Red Cover" Series, each number 25c.*  
No. 7R. Physical Training Simplified  
No. 9R. How to Live 100 Years  
No. 23R. Get Well; Keep Well  
No. 33R. Tensing Exercises  
No. 51R. 285 Health Answers  
No. 54R. Medicine Ball Exercises, Indigestion Treated by Gymnastics, Physical Education and Hygiene  
No. 62R. The Care of the Body  
No. 64R. Muscle Building; Health by Muscular Gymnastics

ANY OF THE ABOVE BOOKS MAILED POSTPAID UPON RECEIPT OF PRICE



GEORGE T. ADEE.  
President United States National Lawn Tennis Association.  
Champlain, Photo.

SPALDING "RED COVER" SERIES OF  
ATHLETIC HANDBOOKS  
No. 57R

SPALDING'S  
LAWN TENNIS  
ANNUAL  
1919

EDITED BY  
SAMUEL HARDY

Explanations of the Laws of Lawn  
Tennis, by E. C. Conlin, Chairman  
National Umpires' Association

PUBLISHED BY  
AMERICAN SPORTS PUBLISHING  
COMPANY  
45 ROSE STREET, NEW YORK



ROBERT D. WRENN,  
New York.  
Former President United States National Lawn Tennis Association.

PART I

**Special Articles, Championships of  
the Year, Ranking Committee's  
Report, Photos of Leading  
Players, Champions of  
Previous Years**

CONTENTS.

|   | Page |
|---|------|
| In Memoriam .....   | 6    |
| Introduction .....  | 9    |
| Thirty Years of Tennis.....                                 | 11   |
| Davis Cup Prospects.....                                    | 17   |
| Resumé of the 1918 Tennis Season.....                       | 21   |
| Lawn Tennis in England.....                                 | 27   |
| American Officers' A.E.F. Championships, Cannes, France.... | 29   |
| Publicity for Tennis Tournaments.....                       | 35   |
| Handicap Tournaments Provide Close Matches.....             | 37   |
| National Championships .....                                | 41   |
| National Doubles Championships.....                         | 51   |
| National Women's Championships.....                         | 55   |
| Clay Court Championships.....                               | 61   |
| National Indoor Championships.....                          | 71   |
| New England Tournaments.....                                | 75   |
| Middle States Tournaments.....                              | 81   |
| Tri-State Tournaments .....                                 | 101  |
| Western Tournaments .....                                   | 107  |
| Southern Tournaments .....                                  | 143  |
| Intermountain Tournaments .....                             | 146  |
| Northwestern Tournaments .....                              | 147  |
| Pacific Coast Tournaments.....                              | 151  |
| Pacific Northwest Tournaments.....                          | 159  |
| Canadian Tournaments .....                                  | 162  |
| Junior Tournaments .....                                    | 163  |
| Ranking Committee's Report.....                             | 174  |
| Official Rankings for 1918.....                             | 176  |
| United States National Lawn Tennis Association—Part II....  | 205  |
| Laws of Lawn Tennis—Part III.....                           | 245  |

[See following page for index of tournaments, etc.]

# Index

## TOURNAMENTS, 1918.

|                                     | Page |                                 | Page |
|-------------------------------------|------|---------------------------------|------|
| Ardley Club Women's                 | 99   | Middle States                   | 81   |
| Atlantic City                       | 100  | Milwaukee, Tennis in            | 125  |
| Bay Counties                        | 157  | Minneapolis Defeats St. Paul    | 150  |
| Border States                       | 145  | Missouri State                  | 140  |
| Bronx Singles and Manhattan Doubles | 90   | Montana State                   | 149  |
| Brooklyn                            | 92   | Nassau C. C. Invitation Doubles | 99   |
| Buffalo City                        | 94   | National Doubles                | 51   |
| California Lawn Tennis Club         | 158  | National Father and Son         | 49   |
| California State                    | 155  | National Singles                | 41   |
| Central New Jersey                  | 100  | National Veterans               | 49   |
| Central Pennsylvania                | 97   | National Women's                | 55   |
| Central States                      | 129  | National Indoor                 | 71   |
| Central States, Women's             | 131  | National Indoor Women's         | 73   |
| Central West Women's                | 140  | New England                     | 75   |
| Chicago City                        | 113  | New England Intercollegiate     | 75   |
| Chicago Public Parks                | 119  | New Hampshire State             | 77   |
| Chicago Tennis Association          | 115  | New Jersey Coast                | 100  |
| Clay Court                          | 61   | New Jersey State Closed         | 94   |
| Cleveland Associated Tennis Clubs   | 103  | New Jersey Women's              | 94   |
| Cleveland City                      | 104  | New York State                  | 87   |
| Colorado State                      | 116  | New York Women's                | 87   |
| Connecticut State                   | 58   | North Carolina State            | 143  |
| Connecticut Valley                  | 78   | North Jersey Coast              | 100  |
| Cuba                                | 115  | Northwestern                    | 148  |
| Denver City                         | 146  | Northwest, Tennis in            | 147  |
| Des Moines Women's                  | 141  | Ohio Intercollegiate            | 106  |
| Detroit, Tennis in                  | 120  | Ohio State                      | 101  |
| Eagles Mere                         | 100  | Oregon State                    | 161  |
| Eastern New York                    | 89   | Pacific Coast                   | 153  |
| East Side of White Mountains        | 79   | Pacific Coast Doubles           | 155  |
| Florida State                       | 144  | Pacific Northwest               | 159  |
| George M. Church Cup                | 96   | Pelham Country Club             | 85   |
| Great Lakes                         | 92   | Pennsylvania State              | 95   |
| Great Plains                        | 137  | Pennsylvania Women's            | 96   |
| Greenwich (Conn.)                   | 79   | Philadelphia Roof Court         | 97   |
| Head of the Lakes                   | 148  | Pinehurst Mid-Winter            | 145  |
| Heights Casino Women's              | 99   | Rhode Island Clay Court         | 79   |
| Husbands and Wives (N. Y.)          | 99   | St. Louis, Tennis in            | 126  |
| Idaho State                         | 150  | St. Louis Tennis Association    | 133  |
| Illinois State                      | 111  | San Francisco and District      | 151  |
| Indiana, Tennis in                  | 105  | San Francisco Women's           | 156  |
| Inland Empire                       | 161  | Southampton                     | 85   |
| Intermountain                       | 145  | Southern                        | 143  |
| Interstate                          | 111  | Southern Intercollegiate        | 145  |
| Iron Mountain                       | 79   | Southern California, Tennis in  | 157  |
| Kansas City, Tennis in              | 135  | Southern Maine                  | 79   |
| Kansas State                        | 141  | South Jersey                    | 100  |
| Kentucky State                      | 106  | Springfield (Mass.)             | 79   |
| Kings County Tennis Club            | 99   | Sullivan County                 | 92   |
| Lake Erie Tennis League             | 100  | University Heights Tennis Club  | 99   |
| Lake George                         | 99   | Utica City                      | 99   |
| Long Island                         | 91   | Washington State                | 159  |
| Longwood Women's                    | 77   | Westchester County              | 99   |
| Los Angeles City                    | 158  | Western                         | 107  |
| Massachusetts State                 | 76   | Western Intercollegiate         | 141  |
| Metropolitan                        | 83   | Western Pennsylvania            | 98   |
| Metropolitan Women's                | 84   | Westmoreland County             | 100  |
| Michigan State                      | 121  | Worcester (Mass.)               | 73   |

## JUNIOR TOURNAMENTS, 1918.

|                              |     |                                 |     |
|------------------------------|-----|---------------------------------|-----|
| Atlantic City Junior         | 173 | Los Angeles Boys                | 173 |
| Brooklyn Junior and Boys     | 168 | Metropolitan Girls' Junior      | 167 |
| Buffalo Junior and Boys      | 172 | Metropolitan Girls' Open        | 167 |
| Canadian Junior              | 168 | Metropolitan Junior and Boys    | 166 |
| East Side of White Mountains | 172 | National Junior and Boys        | 165 |
| Edgewood Junior and Boys     | 173 | National Indoor Junior and Boys | 165 |
| Interstate Junior            | 173 | New Jersey Coast Boys           | 172 |
| Iron Mountain Junior         | 172 | Northwestern Interscholastic    | 173 |
| Kansas City Junior           | 170 | Oregon Junior and Boys          | 171 |
| Longwood Junior and Boys     | 169 | Pacific Coast Junior            | 171 |

JUNIOR TOURNAMENTS—Continued.

|                                | Page |                               | Page |
|--------------------------------|------|-------------------------------|------|
| Pacific Northwest Junior.....  | 173  | Yale Alumni Association.....  | 168  |
| Philadelphia Roof Court.....   | 173  | Yale Interscholastic.....     | 169  |
| St. Louis Junior and Boys..... | 170  | Westfield (N. J.) Junior..... | 172  |
| Seattle Junior.....            | 173  | Woodmere Club Junior.....     | 172  |
| Southern Junior and Boys.....  | 170  |                               |      |

PREVIOUS CHAMPIONS.

|  |     |                            |     |
|--|-----|----------------------------|-----|
| Bay Counties.....                      | 200 | National Doubles.....      | 188 |
| California State.....                  | 200 | Finalists.....             | 190 |
| Clay Court.....                        | 192 | National Singles.....      | 188 |
| Davis Cup Doubles.....                 | 186 | Semi-finalists.....        | 189 |
| Davis Cup Singles.....                 | 182 | National Women.....        | 192 |
| English Doubles.....                   | 202 | National Indoor.....       | 193 |
| English Lady.....                      | 203 | National Indoor Women..... | 193 |
| English Singles.....                   | 201 | New England.....           | 195 |
| Intercollegiate.....                   | 194 | Nice Lawn Tennis Club..... | 204 |
| Interscholastic.....                   | 198 | Pacific Coast.....         | 199 |
| Longwood Singles, Eastern Doubles..... | 197 | Southern States.....       | 196 |
| Metropolitan.....                      | 198 | South of France.....       | 204 |
| Middle States.....                     | 195 | Western States.....        | 196 |

ILLUSTRATIONS.

|                                     |        |  |          |                           |     |
|-------------------------------------|--------|--|----------|---------------------------|-----|
| Adams, John W., Jr.....             | 132    | Guest, Capt.....                       | 26       | Pell, Theodore R.....     | 38  |
| Adee, G. T....Frontispiece          |        | Hall, Walter Merrill.....              | 80       | Pentfold, Howard.....     | 122 |
| Adoue, J. B., Jr.....               | 142    | Handy, Miss Edith B.....               | 72       | Prentice, Bernon S.....   | 32  |
| Alexander, Fred B.....              | 50     | Hardy, Samuel.....                     | 10, 64   | Rameson, Mrs. J. A.....   | 138 |
| Anderson, Frank T.....              | 164    | Hardy, Dr. Sumner.....                 | 68       | Raymond, Mrs. E.....      | 72  |
| Anderson, Fred C.....               | 164    | Harker, Don.....                       | 134      | Rice, Miss Helen.....     | 72  |
| Armstrong, Joseph J.....            | 86     | Harris, Fred H.....                    | 46       | Richards, Vincent.....    | 70  |
| Bailey, E. R.....                   | 134    | Hayes, Walter T.....                   | 108, 110 | Roberts, Roland.....      | 152 |
| Baker, Miss Helen.....              | 154    | Hennessey, John.....                   | 134      | Roehr, R. B.....          | 124 |
| Ballin, Miss Florence.....          | 88     | Herd, Clifton B.....                   | 26       | Rosenbaum, Dr. W.....     | 68  |
| Beekman, Leonard.....               | 46     | Hoskins, A. L.....                     | 86       | Saunders, Goddard W.....  | 163 |
| Behr, Karl H.....                   | 38     | Hitchins, Mrs. V. C.....               | 82       | Sears, Miss Eleonora..... | 82  |
| Biddle, Craig.....                  | 130    | Hubbell, Arthur.....                   | 134      | Seavey, Miss Evelyn.....  | 138 |
| Bjurstedt, Miss Molla.....          | 54     | Hunter, Francis T.....                 | 26       | Sheafe, Edwin.....        | 48  |
| Brain, Phil.....                    | 122    | Inman, Fred C.....                     | 44       | Smith, Carleton Y.....    | 142 |
| Brookes, Norman E.....              | 14     | Jackson, Wilbur.....                   | 118      | Taylor, Harold L.....     | 164 |
| Browne, Miss Mary K.....            | 56     | Johnson, Harry C.....                  | 68       | Thornton, Nat.....        | 142 |
| Bull, Charles M., Jr.....           | 74     | Johnson, Col. Wait C.....              | 28       | Thorward, B. F.....       | 102 |
| Bundy, Thomas C.....                | 85     | Johnson, Wallace F.....                | 74       | Throckmorton, H. A.....   | 52  |
| Bundy, Mrs. T. C.....               | 56     | Johnston, William M.....               | 22       | Tilden, W. T., Jr.....    | 62  |
| Burehard, Ross.....                 | 48     | Kinsey, Howard.....                    | 152      | Torrey, Edwin F.....      | 206 |
| Burdick, Ralph H.....               | 110    | Kinsey, Robert.....                    | 152      | Van Arsdale, R. L.....    | 116 |
| Cabell, S. W.....                   | 102    | Knox, Harry S.....                     | 116      | Voshell, S. Howard.....   | 128 |
| Chapin, Alfred H.....               | 208    | Kumagae, Ichiya.....                   | 80       | Wagner, Miss Marie.....   | 58  |
| Church, George M.....               | 44     | Larned, Edwin P.....                   | 48       | Waidner, L. H.....        | 46  |
| Conlin, Edward C.....               | 244    | Larned, William A.....                 | 26       | Wallach, Mrs. Barger..... | 88  |
| Cunningham, William.....            | 86     | Mathey, Dean.....                      | 44       | Washburn, Watson M.....   | 24  |
| Davis, Dwight F.....                | 16     | McGee, John.....                       | 122      | Watters, Douglas.....     | 142 |
| Davis, Willis E.....                | 46     | McLoughlin, M. E.....                  | 18       | Westbrook, Walter.....    | 122 |
| Doyle, Conrad B.....                | 52     | McNeill, Mrs. M.....                   | 138      | Wick, H. C., Jr.....      | 102 |
| Drewes, Theodore R.....             | 132    | Morse, Mrs. H. F.....                  | 82       | Wildman, Mrs. G. W.....   | 58  |
| Esch, Miss "Bobbie".....            | 68     | Murray, R. Lindley.....                | 42       | Wilding, Anthony F.....   | 12  |
| Field, Mrs. Ralph.....              | 66     | Myers, Miss Anita.....                 | 154      | Williams, Paul B.....     | 210 |
| Gardner, Carl R.....                | 68     | Myers, Wallis.....                     | 26       | Williams, R. Norris.....  | 20  |
| Garland, C. S.....                  | 36, 64 | Myrick, Julian S.....                  | 8        | Wood, Mrs. Rawson.....    | 88  |
| Grant, B. M.....                    | 142    | Neely, Miss Carrie B.....              | 112      | Wrenn, Robert D.....      | 2   |
| Griffin, Mervyn.....                | 152    | Niles, Nathaniel W.....                | 74       | Wright, Beals C.....      | 50  |
| Gohert, A. H.....                   | 26     | Obeart, Davison.....                   | 132      | Wright, Irving C.....     | 68  |
| Gould, Miss Corinne.....            | 116    | Oelsner, Edward.....                   | 118      | Zinderstein, Miss M.....  | 72  |
| American Officers at Cannes.....    | 30     | Group at Montana Championships.....    | 132      |                           |     |
| Chicago Players.....                | 118    | Presentation of Ambulance Service..... | 34       |                           |     |
| Detroit Tennis Club.....            | 102    | South Park Tennis Club.....            | 119      |                           |     |
| Group at National Championship..... | 41     | South Side Tennis Club.....            | 60       |                           |     |
| Milwaukee Players.....              | 124    | West Side Tennis Club.....             | 40       |                           |     |

Many of the illustrations in the 1910 Annual are reproductions of the remarkable photographs taken by the Corte-Scope Co., Cleveland, Ohio, at the 1918 championship and other prominent tournaments. They are reproduced by permission and through the courtesy of the Corte-Scope Co., to whom acknowledgment is here given. Acknowledgment is also made to "American Lawn Tennis" for courtesies extended.



## In Memoriam

Those Who Have Made the Supreme Sacrifice

*Allegheny Country Club,  
Sewickley, Pa.*

LIEUT. T. W. CULBERTSON

*Baltimore (Md.) Country Club*  
CAPT. FRED'K C. COLSTON

*Bay Head (N. J.) Yacht Club*  
EDWARD C. BONNELL  
MAJOR HENRY S. CLARK  
JOSEPH F. EDWARDS  
PHILIP HASSINGER  
FRANKLIN PERRY

*Bismarck (N. D.) Country Club*  
FRANK L. SHUMAN

*California Association*  
LIEUT. H. S. MORGAN

*Century Country Club,  
White Plains, N. Y.*  
CAPT. JOSEPH S. BACH

*Cherry Valley Club,  
Garden City, N. Y.*  
BRADFORD W. TURNER

*Columbia University, New York*  
LIEUT. JAMES S. O'NEALE

*Country Club of Virginia,  
Richmond, Va.*

JOHN CADET DUNN

*Cynwyd Club, Cynwyd, Pa.*  
CAPT. J. G. DUNCAN, JR.  
LIEUT. WILLIAM B. KUEN  
E. M. SPANGLER

*Denver (Colo.) Country Club*  
RAYMOND J. MCPHEE  
EBEN L. SMITH

*Elmhurst (N. Y.) Tennis Club*  
RUSSELL CHAPMAN  
ERNEST B. PLITT

*Harlem Tennis Club, New York*  
PAUL M. ANDREWS

*Harvard University,  
Cambridge, Mass.*

LIEUT. H. A. LAWTON  
LIEUT. R. B. ROCKWOOD

*Indiana Association*  
LIEUT. W. A. FLEET

*Lake George Club,  
Diamond Point-on-Lake, N. Y.*  
MAJOR A. R. ALLEN

*Longwood Cricket Club,  
Boston, Mass.*

LIEUT. J. S. PFAFFMAN  
LIEUT. PHILIP WINDSOR

*Mantoloking Yacht Club,  
South Amboy, N. J.*  
LIEUT. STEWART EDGAR  
LIEUT. BARRY WALL

*Merion Cricket Club,  
Haverford, Pa.*

LIEUT. LOVELL H. BARLOW  
LIEUT. BENJ. BULLOCK, 3D  
CAPT. P. P. CHRYSTIE  
ENSIGN GEO. B. EVANS, JR.  
LIEUT. T. B. W. FALES  
CAPT. C. P. FREEMAN  
LIEUT. ROBT. H. GAMBLE  
CAPT. ALAN W. LUKENS  
CAPT. HOWARD C. MCCALL



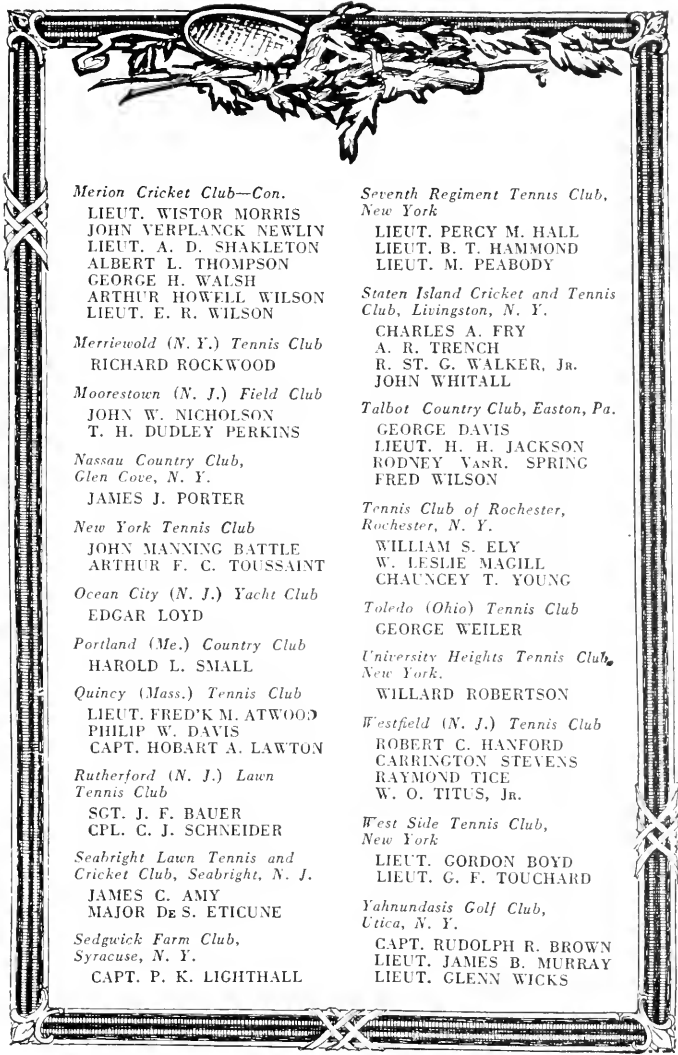

*Merion Cricket Club—Con.*

LIEUT. WISTOR MORRIS  
JOHN VERPLANCK NEWLIN  
LIEUT. A. D. SHAKLETON  
ALBERT L. THOMPSON  
GEORGE H. WALSH  
ARTHUR HOWELL WILSON  
LIEUT. E. R. WILSON

*Merriewold (N. Y.) Tennis Club*  
RICHARD ROCKWOOD

*Moorestown (N. J.) Field Club*  
JOHN W. NICHOLSON  
T. H. DUDLEY PERKINS

*Nassau Country Club,  
Glen Cove, N. Y.*  
JAMES J. PORTER

*New York Tennis Club*  
JOHN MANNING BATTLE  
ARTHUR F. C. TOUSSAINT

*Ocean City (N. J.) Yacht Club*  
EDGAR LOYD

*Portland (Me.) Country Club*  
HAROLD L. SMALL

*Quincy (Mass.) Tennis Club*  
LIEUT. FRED'K M. ATWOOD  
PHILIP W. DAVIS  
CAPT. HOBART A. LAWTON

*Rutherford (N. J.) Lawn  
Tennis Club*  
SCT. J. F. BAUER  
CPL. C. J. SCHNEIDER

*Seabright Lawn Tennis and  
Cricket Club, Seabright, N. J.*  
JAMES C. AMY  
MAJOR DE S. ETICUNE

*Sedgwick Farm Club,  
Syracuse, N. Y.*  
CAPT. P. K. LIGHTHALL

*Seventh Regiment Tennis Club,  
New York*

LIEUT. PERCY M. HALL  
LIEUT. B. T. HAMMOND  
LIEUT. M. PEABODY

*Staten Island Cricket and Tennis  
Club, Livingston, N. Y.*

CHARLES A. FRY  
A. R. TRENCH  
R. ST. G. WALKER, JR.  
JOHN WHITALL

*Talbot Country Club, Easton, Pa.*

GEORGE DAVIS  
LIEUT. H. H. JACKSON  
RODNEY VANR. SPRING  
FRED WILSON

*Tennis Club of Rochester,  
Rochester, N. Y.*

WILLIAM S. ELY  
W. LESLIE MAGILL  
CHAUNCEY T. YOUNG

*Toledo (Ohio) Tennis Club*  
GEORGE WEILER

*University Heights Tennis Club,  
New York.*

WILLARD ROBERTSON

*Westfield (N. J.) Tennis Club*

ROBERT C. HANFORD  
CARRINGTON STEVENS  
RAYMOND TICE  
W. O. TITUS, JR.

*West Side Tennis Club,  
New York*

LIEUT. GORDON BOYD  
LIEUT. G. F. TOUCHARD

*Yahnundasis Golf Club,  
Utica, N. Y.*

CAPT. RUDOLPH R. BROWN  
LIEUT. JAMES B. MURRAY  
LIEUT. GLENN WICKS



JULIAN S. MYRICK.

New York.

Vice-President United States National Lawn Tennis Association.

With the departure of F. B. Alexander for an officers' training camp, the editorship of Spalding's Annual was given into the hands of Samuel Hardy.

Mr. Hardy has long been identified with tennis, his first championship having been won in 1891, when he, together with his brother Sumner, secured the Pacific Coast doubles title. A close student of the game, as well as one of its most enthusiastic supporters, his intimate acquaintance with players here and abroad makes him particularly well fitted to succeed Mr. Alexander.

AMERICAN SPORTS PUBLISHING CO.



SAMUEL HARDY,  
Editor Spalding's Lawn Tennis Annual.

## Thirty Years of Tennis

BY SAMUEL HARDY.

When I began to play tennis in the late '80s, I was much more concerned over beating little Tommy Jones, who lived around the corner, than in the struggle then waging for the national championship at Newport between Beeckman and Slocum, who aspired to defeat R. D. Sears, seven times champion. Being self-taught, my racket grips and strokes were faulty—I have always wished I might have had a teacher in those days—and my progress in the game came chiefly from a natural volleying ability. By degrees my brother Sumner and I forged ahead until we gained first position in that part of the country, and in 1899 we successfully defended the Pacific Coast doubles against the first Eastern invasion.

The members of this team comprised Whitman, then the national singles champion; his young and untried partner, Beals Wright, and the national doubles champions, Ward and Davis. Holcombe Ward had not then attained the skill which later made him the American champion, but he already was proficient in the use of the new American twist service. Dwight Davis had an even more terrible service, being left-handed. When in a winning streak, he carried all before him. I well remember how he swept me off the court when first I went up against this horrible curly service, which broke away to the forehand, almost out of reach. My brother at once grasped the truth that one must stand well inside the service line in order to take the ball on the rise, returning it before the server can gain a place at the net. Years later, Cecil Parke was to learn this of McLoughlin's serve. I remember seeing him go down easily in straight sets in the British championship. He stood six feet behind the service line when receiving. Only a few weeks later, he surprised his most ardent supporters by defeating McLoughlin in the Davis Cup contest on the same court. Everyone saw at a glance that his success was due to his changed position in receiving the service.

To return to ancient history, my brother and I defended the Pacific Coast doubles with success. Whitman and Wright had put out Ward and Davis in the finals and the challenge round found them too newly paired for proper team work. Our success was in part due to the excellent practice we had had with the Neel brothers, Carr and Sam, who had recently moved from California to Chicago. Scarcely had they been there a year or two, when they annexed the national doubles; while Carr, ever the better singles player, played R. D. Wrenn a five-set match at Newport when Wrenn was at his best.

Whitman's game at this time had reached the height of its perfection. Twice national champion and without a weakness of any kind, he combined superb passing shots with a safe volley game. So sound was he considered overhead, that it was said of him that he considered every ball lobbed to him as his point. I still chuckle, therefore, when I recall the manner in which I took a set from him in an exhibition match at Del Monte. Knowing how superior was his backcourt game to mine, I resolved to bring him to the net at every opportunity. There I proposed to stay myself and fight it out with him. I therefore returned every serve with a cut, with the intent to drop it just over the net, knowing that it was not his custom to follow the serve in. For a while this worked like a charm; sometimes he would tear up for a short one and put it right into my hands; sometimes he would pass me down the side lines. But



**ANTHONY F. WILDING.**

Killed in action early in May, 1915, Wilding was four times champion of England. He ended his career as an international player by successfully invading the United States in 1914 with Brookes, this famous Australasian pair winning the challenge round of the Davis Cup matches of that year.

the fact remains that I took the first set at 6/1. Of course, when he "got going," he soon mastered this new style of attack and smothered me; but I have always enjoyed winning that one set, which, by the way, was the only set he lost that year to so bad a score.

The following year—1900—Dwight Davis presented to the National Association a huge silver trophy, in order to stimulate interest in international matches. He certainly succeeded in his purpose, for the Davis Cup soon became famous throughout the world, and no prize ever has been more keenly sought. Davis and Whitman defended it successfully that year, and it was not until the second attempt of the Dohertys in 1904 that the cup was lifted.

Wrenn, after saving the American championship three times, had now retired. To his fine net game he owed much of his success, yet it was his great fighting spirit which made him the idol of the tennis world. Essentially a match player, he gallantly rose to whatever height the occasion demanded, and his gameness became proverbial. His daring net game had much to do with the then prevailing view that "the net game was the only game," and was far superior to the British backcourt game, of which Richard Stevens was the staunchest and ablest American supporter of his time. It remained for a later generation to demonstrate that it is the combination of these two styles of play that forms the ideal arrangement.

Larned in 1900 had not yet attained that perfection of play that later enabled him to retain the American championship seven years, but he was Whitman's chief rival. The rising young players of this day, afterward famous in many a championship and Davis Cup contest, were Alexander, Little, Hackett, Clothier and Ware. Ward and Davis had already attained fame as a national doubles team and owed their success not alone to their fine team work, but to the then unique American twist service.

University life and business claiming my attention for a decade or so, it was not until 1910 that I resumed tournament play, this time in England. During this interval Larned had come into his own, while Ward, Wright and Clothier, each in turn American champion, had all been exponents of the net attack.

When Brookes first won the title of world's champion, the famous Dohertys had retired from English tennis. "H. L." is considered by many in this country to be the better player of the two brothers, but in England few share this view. Did not "R. F." defend his country against the American invasion successfully? Ward led him two sets to none before he conquered the American twist service. Larned, Behr, Collins and Wright all tried in vain. If Wright, while going abroad, had not suffered an accident which resulted in the loss of a finger of his playing hand, there might have been another story to tell, for he was America's great natural player and was at the height of his career. Years later he was able to carry Wilding, then at the top of his (Wilding's) game, to five sets before succumbing to superior stamina. Some idea of the closeness of this match may be gained when one recalls that the score of each set was 6/4.

My introduction into English tennis life found me playing with three men who were later to lose their lives in the great war. I was partnered by my old friend, R. B. Powell, afterward captain of the Canadian Davis Cup team, while against us were Kenneth Powell, England's champion hurdler and one of the finest sportsmen that ever lived, and Anthony Wilding. The first set equaled in score, if not in intensity of interest, the famous 17/15 set between Brookes and McLoughlin. Wilding in those days was not considered particularly good at doubles, but his game improved very much during the next two or three years.

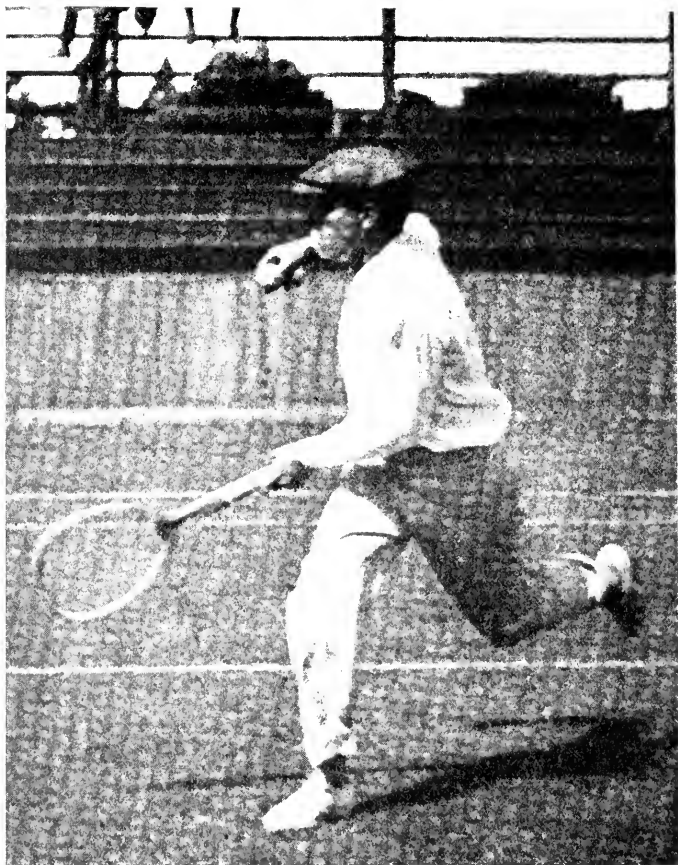

NORMAN E. BROOKES.

Australasia's premier singles player and twice winner of the English championship. Brookes and Wilding have represented Australasia in Davis Cup matches since 1905 and were a smooth-working combination.



At singles he was irresistible. His obvious zest for the game, his abounding vitality and endurance and his court craft, made it a pleasure to watch him. He successfully withstood the assaults of the players of all countries save his own. America sent Wright; Belgium, de Borman; France, Decugis, Gobert and Germot; Germany, Froitzheim, Rahe and Kreuzer. Depending, especially in his late years, almost solely on his backcourt game, though able to volley well if forced to the net, Wilding owed his success largely to his wonderful physique, which enabled him to cover miles of territory and still maintain the sting in his drives in the fifth set. Parke is of like endurance, and had he given the same time and attention to the game, might well have beaten him.

When Wilding was at the very height of his fame, I well remember the defeat he received at Queen's Club in 1912, at the hands of George Caridia, the famous half-volleyer. Caridia, ever a comparatively poor grass court player, was at his best on the fast wood courts of Queen's. He has developed a peculiar style, most exasperating to an opponent. After serving, he steps forward into that most dangerous position to the average player, half-way between the service and the base line. His uncanny half-volleying ability enables him to maintain this position to advantage. He meets the return with a sweeping half-volley, which carries the ball to a distant corner and keeps his poor opponent running from side to side until he is exhausted. On this particular day, Caridia was at his best and kept the champion running until even he was obliged to rest. Caridia won four straight sets, 6/1, 6/2, 6/3, 6/4, a feat no other man alive could have accomplished.

While this war has deprived us of Wilding, there is still plenty of available Davis Cup material in England and on the Continent, and it behooves us to gather together our best team for the struggle coming in 1920. Gobert and Decugis of France are still to be reckoned with, not to mention Laurenze, who once defeated Wilding; Parke has recovered from his wrist wound and both the Lowes are fitter than ever, while Barrett always can be depended upon for the craftiest game possible. Froitzheim, that silent inscrutable player, will again head the German team—if it be admitted to the world of sport—and he is a man to be feared on any court in the world. Capable of winning from any of his countrymen in straight sets, his mettle has been tested in the severest Davis Cup matches. He ran McLoughlin to five sets and defeated Parke. His backcourt strokes are a model of perfection; his follow through is apparent after each shot, while his ability to cover court in his seemingly listless manner is equal to Wilding's. Gobert is another player likely to be heard from. Gifted with a marvelously smooth action, he always plays in perfect form, delivering his speedy forehand and backhand drives with slight effort.

In Australasia, Doust and Dunlop come next in fame to Brookes and Wilding; indeed, it is the claim of many that as a doubles team the former were superior. It is doubtful if Australasia can retain the Davis Cup without the aid of Brookes. Will this great player again defend his country? Who can doubt that he could do so successfully if he would? Did he not, after an absence of seven years, return to England and defeat Wilding, four years undisputed champion? Brookes won in straight sets. His stronger personality so dominated Wilding that the latter was unable at any time to do himself justice.

On the whole, America will have the likeliest chance of winning the Davis Cup. Perhaps 1919 will bring forth new European champions; but America has suffered so little in the war that, with her greater field from which to draw, she should emerge triumphant in the coming struggle.

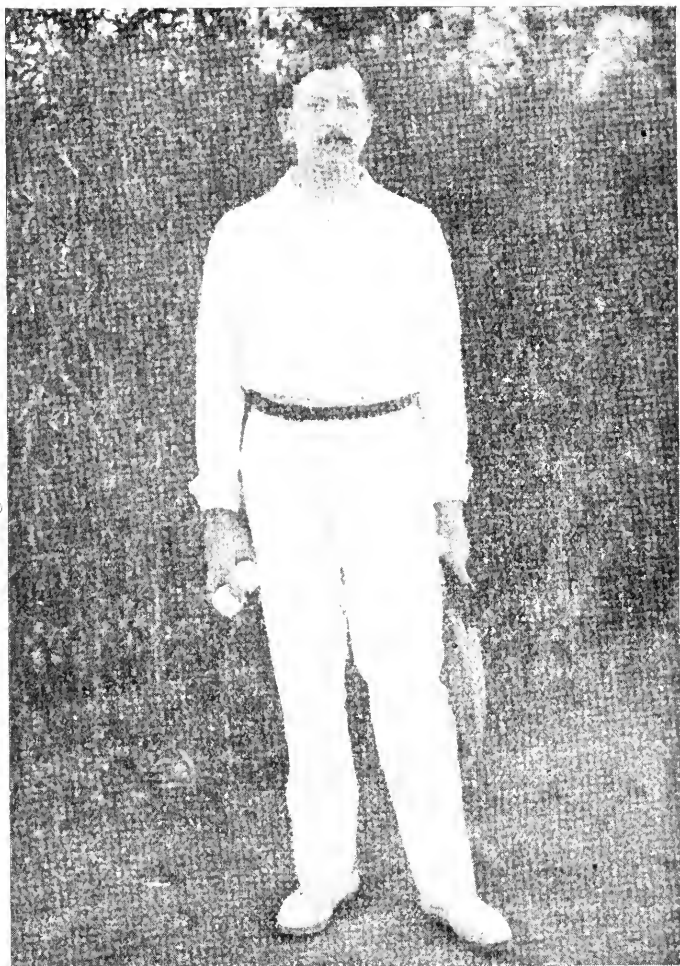

DWIGHT F. DAVIS,  
St. Louis, Mo.

Donor of the famous cup to promote international competition, but to which also must be attributed much of the universal development of lawn tennis.

## Davis Cup Prospects

BY SAMUEL HARDY.

With the return to more normal conditions, the most interesting question to the tennis enthusiast at once becomes, "Who will win the Davis Cup?" During the war, contests for the coveted trophy were abandoned. It was even felt unsafe to intrust the famous cup to the perils of the long sea voyage to Australia, so it has remained throughout the war in this country.

Almost as soon as the armistice was signed, tennis associations throughout the world began to plan for the next international competition. \*France, always an eager participant, issued an immediate challenge to Australasia, but our Davis Cup Committee felt that a year of peace and preparation before the next contest would be more fair to Great Britain. Australasia had lost her great player, Wilding; Canada the captain of her team, R. B. Powell; while England had stated that Parke and Dixon, two of her former team, no longer would be available.

Without doubt there is good Davis Cup material in all these countries, and time alone is needed for development of the younger players. A year will prove all too short a time for turning out Davis Cup men of the first flight, for even McLoughlin had to go through an apprenticeship of several years before attaining success.

The countries which are expected to compete are the United States, England, France, Canada, Belgium, Roumania, and possibly Russia and Italy, the winner to challenge the cup holder—Australasia. Japan, if only she would, could enter a strong team in Kumagae, Kashio and Mikami. Germany will not be eligible, since she proved during the war that she lacks the sporting instinct. Her slinking submarines, her dastardly intrigues, and her readiness to adopt any dishonorable means promising success, has left her a pariah among the civilized nations of the earth. It is quite fitting, therefore, that she be excluded from the world of sport while she is still unregenerate, although all lovers of tennis regret the necessity of barring Froitzheim, Rahe, Kreuzer and the Kleinschroths, whose conduct on the courts always has been exemplary.

Of all the teams that can be entered by these countries, there can be no question that the entry from the United States should be the strongest, with France or England opposed to her in the finals.

The United States has an exceptionally fine group of men to draw upon. With no losses from the war and her youthful champions strengthened by military service, a season's practice should put her men into perfect condition and make defeat almost impossible. With Williams, Johnston, Murray, Alexander, Church, Strachan and Tilden, two teams could be formed, either of which should be able to bring back the cup. Many think that McLoughlin's best tennis days are over, but those who know his game best, claim that he is quite capable of playing at the top again, and it is sincerely hoped that he will decide to enter the race.

France will have Gobert, always a player of great possibilities and now steadied and matured by his four years of war; Decugis, Germot, and the brilliant Laurence. With such a team, it is little wonder that France issued an immediate challenge.

\*England, France and Belgium issued a challenge to Australasia for 1919 shortly after this article was written.



MAURICE E. McLOUGHLIN,  
San Francisco,

National Champion, 1912 and 1913; conqueror of Brookes and Wilding, the famous Australasian players, in the Davis Cup matches of 1914. McLoughlin was known as the "Comet" because of his furious energy while playing.

England has lost her greatest player, Parke, who declares his tennis days to be over; but she still has two former Davis Cup men for the singles in Arthur and Gordon Lowe. Gore, Barrett and Ritchie have served their country loyally for years, and now may feel that an opportunity for development should be given younger men, among the most promising of whom are Davson and Kingscote.

Canada scarcely can be considered a serious opponent without her captain, R. B. Powell, nor can Roumania, whose team doubtless will be headed by Mishu. Belgium, too, will be weak, though she still has her captain, de Borman.

Australasia, despite the loss of Wilding, is capable of putting up a stiff resistance, provided Brookes competes. She has the advantage of playing on her own courts, and her players are accustomed to the climate that is always so trying to visiting teams. Brookes has stated his willingness to compete in 1920 if he finds himself in good form at that time. It is to be hoped that he will participate, since Australasia cannot possibly replace him in singles. Doust, Dunlop, Jones and Heath are scarcely good enough in singles to oppose with much hope of success the winning team which will have proven itself master of the rest of the world. But it is known that Brookes has hopes of the younger generation. Gerald Patterson, whose style is somewhat that of Wilding's, is his first choice, while the more brilliant but less dependable Anderson is a close second. O'Hara Wood and Sandral are also possibilities.

In doubles, Brookes would not be so vitally necessary to success. Doust and Dunlop were considered by many to be a better combination than Brookes and Wilding, an opinion shared by the former pair, since they repeatedly tried, without success, to engage the more famous pair in a sporting match.

Some indication of the personnel of the 1920 teams may be gained by watching for the winners of this year's tournaments. There now seems every likelihood that the younger element will displace a few of the veterans, as every country realizes the necessity of training its young men for future contests. But while the rivalry will be intense, the spirit of the contenders will be most friendly, as befits allies who have gone through a war together fighting in a common cause. This alliance was in a measure made possible by the friendly feeling created in no small degree by international contests, and it is to be hoped that future competitions will only serve to cement the cordial relationship now existing between these countries.



CAPT. R. NORRIS WILLIAMS, 2D.

National Champion, 1911 and 1916; United States Clay Court Champion, 1912 and 1915; twice winner of the Intercollegiate Championship, 1913 and 1915, while a student at Harvard University; winner of the American Officers' A.E.F. Championship in singles and doubles, at Cannes, France, February, 1919.

## Resumé of the 1918 Tennis Season

BY SAMUEL HARDY.

When America responded to the call of the Allies in the great war by sending abroad her armies with unprecedented dispatch, tennis men from all parts of the country were among the first to enlist; indeed many of them were already serving as volunteers. Of the first ten, Murray alone remained in America, his valuable services as a Government chemist detaining him here despite his incessant plea for service abroad.

Early in the year the prospect for a successful season appeared gloomy. Every club in the land had lost a big percentage of its members and all prominent players were in some sort of service, so that a repetition of the Ambulance Fund matches of 1917 was out of the question. The National Association met the situation by announcing quite early in the year that championship titles and trophies would be resumed. This proved just the stimulus required, for both players and public at once realized the possibility of a new set of champions appearing, and there was much speculation as to whether veterans or juniors would dominate. Such well known stars as Alexander, Wright, Pell, Niles, Hall and Ward represented the old guard, while a host of younger players had visions of winning the national singles title.

It became apparent quite early in the season that William Tilden, Jr., of Philadelphia had to be reckoned with. Emerging from the Church Cup competition undefeated, he took Voshell's measure in the New York Tennis Tournament and then annexed the Pennsylvania championship without the loss of a set. He defeated Garland in Pittsburgh and again in Chicago at the Clay Court championships, where he also won a splendidly played four-set match from Hayes. Later he defeated Murray in an exhibition match at Buffalo.

The Pacific Coast was not represented in any of the big tournaments. McLoughlin, Johnston and Strachan were serving in the navy, while Griffin and Davis were in the army. The West was not wholly unrepresented, however, for Chicago sent its best known doubles team, Burdick and Hayes, to compete in the national events. It was Hayes' misfortune to turn an ankle on the first day of practice, thus losing his team whatever chance of success it may have had.

The national doubles at Longwood was the first meeting held under the new system, the sectional and preliminary doubles and the challenge round having been done away with. Tilden and Richards won the title from Alexander and Wright in a final five-set match that was at times both thrilling and spectacular. The winners had given an indication of their quality by defeating Irving Wright and Harry Johnson in the first round. With such ease was this accomplished that any disposition to regard them lightly was at once dispelled. A hard tussle with Niles and Pell brought Tilden and Richards to the final, where their opponents, Alexander and Wright, were looked upon as almost certain winners. The latter had had a hard tussle with Kumagai and Taylor, but their easy victory over Hayes and Burdick in the semi-finals found them fresh and confident of winning the championship. Richards now justified his previous victories by again playing sound tennis. The match went to five sets, when the younger pair won in a final burst of speed in which Tilden, who had all along done more than half the work for his side, was fully supported by his partner. So a new national champion, a lad of sixteen, was added to the list of famous American players. Tilden's stock now rose higher than ever.



WILLIAM M. JOHNSTON,  
San Francisco,  
National Champion, 1915.



With the exception of Alexander's indoor win over him prior to the opening of the grass season, he could show an unbroken record of victories including two national titles, the doubles and the clay court. Could he win the third and richest prize, the national singles? The two men most to be feared were Kumagae and Murray.

When Kumagae returned unexpectedly to America in July, all tennis fans recalled that he had been ranked fifth in 1916, and fear was openly expressed that the national title would go to Japan. This menace of a foreign title-holder was more than Lindley Murray could stand and was the deciding factor in causing his re-entry into the tennis world. Unwilling to play merely for the personal honor of winning a national championship, he felt it to be his duty to his old comrades of the first ten, in service abroad, to defend his country from this invader during their absence; he would serve in the home campaign if unable to do so in the one abroad. With the singles championship but a fortnight away, he had little time for preparation. Always in perfect physical condition, his chief concern was lack of practice.

At the Southampton tournament, always played just before the national championships and considered to be the most reliable barometer for the rough passage of Forest Hills, Tilden won from Murray in straight sets. He now became the favorite for the national title. Before the great day arrived, when they met in the finals, each had had his escapes from disaster; Niles had taken Murray through four hard sets and Alexander had carried him to five, while Tilden had dropped two sets to Hall, the victor of Hayes.

The great match proved that Murray had found himself. He descended upon the Philadelphian like a whirlwind, smothering him in straight sets. Had Tilden won the third set, which he lost at 5/7, he might have gone on to victory, Murray's severe net game being difficult to maintain during five sets. But the victor was not to be denied and his tempestuous attack combined with his improved ground strokes, carried him through to a straight-set win. It must be said in fairness to Tilden that he was far from well at the time of the match.

Miss Molla Bjurstedt of Norway and New York won the thirty-first annual women's championship by defeating Miss Eleanor Goss in the challenge round. She thus brackets her name with other three-time winners—Miss Anderson, Miss Moore, Miss Hotchkiss and Miss Browne. Paired with her countrywoman, Mrs. J. Rogge, she lost the national doubles to Miss Goss and Miss Zinderstein by a close margin, and the mixed doubles with Fred Alexander to Mrs. Wightman and Irving Wright. America owes a debt or gratitude to this Norwegian girl who has so consistently and cheerfully given her services throughout the war in many cities of the East and West in exhibition matches for the benefit of our soldiers. Her sensational series of matches with Miss Browne in 1917 will be long remembered, while her willingness to travel hundreds of miles to aid in raising funds by her play evinces a spirit that is gratefully recognized throughout the tennis world.

When the officers of the National Association resumed the practice of giving trophies and titles, they made a special plea for the encouragement of tennis among boys and juniors. Acting-President Julian S. Myrick, whose whole-hearted devotion to tennis has done so much to bring about a closer fellowship between players all over the country, had given much time and thought to the improvement of the game among the younger element. Over fifty special tournaments throughout the country were arranged for boys and

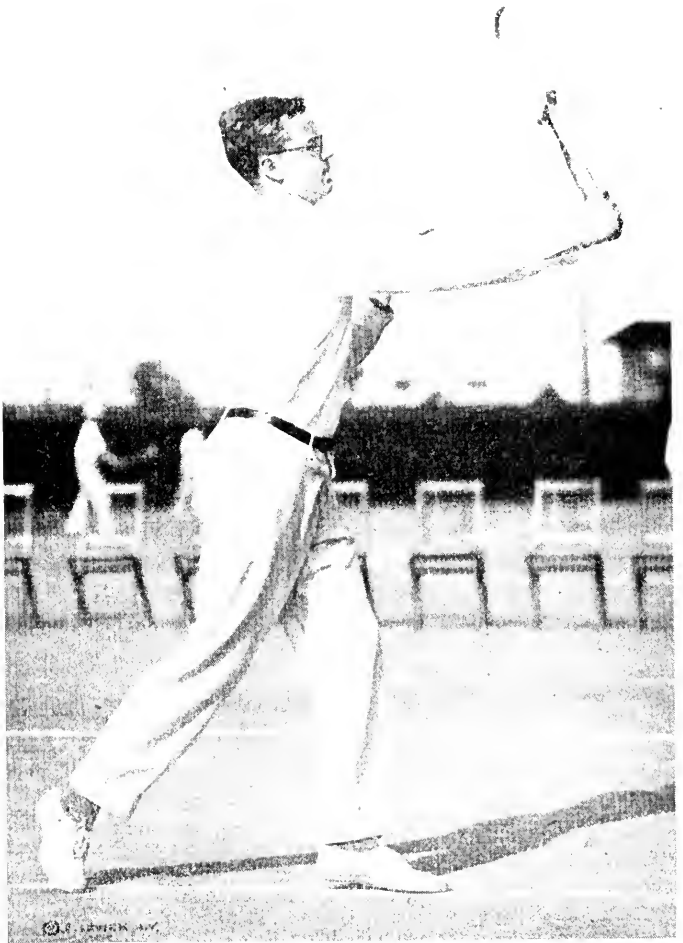

WATSON M. WASHBURN.  
New York.

juniors; to these were added for the first time several girls' meetings, including the first national girls' championship held in conjunction with the national women's championship at Philadelphia. The girls' singles was won by Miss Katherine Porter. Vice-President Myrick was in the chair and the match was conducted in impressive style with the full quota of linesmen, as befits a national event. Vincent Richards won the national boys' title by a victory over A. Bassford, 3d, while Harold Taylor became junior champion, defeating John Hennessey of Indianapolis in the final.

Not to be outdone by the youngsters, the older element staged two tournaments, the veterans' and the fathers' and sons' national championships. The former event was won by Ross Burchard, whose unexpected death shortly afterward is a loss to the tennis world. The latter tournament, which suffered heavily from defaults, fell to Alfred H. Chapin, senior and junior, of Springfield, Mass.

Considerable discussion arose as to whether Murray or Tilden should be ranked No. 1, since each had gained a victory over the other; but Murray's decisive win in the national singles decided the question in his favor. Tilden easily came second, while Alexander's consistent play throughout the season earned for this hard-working veteran the third place. Hall's five-set win over Hayes at Forest Hills made him fourth, Hayes following. Niles came sixth, while Kumagai dropped from fifth to seventh. Garland and Voshell, eighth and ninth, respectively, while placed near the end of the list, are young enough to look forward with confidence to bettering their positions. Pell of the famous backhand is tenth man, just beating Burdick of Chicago for this place.

In 1917 the revenue from all tournaments was donated to the Red Cross, but this organization having been supplied with ample funds by the public, the National Association in 1918 directed that all revenues from clubs be applied to the War Department Fund for Soldiers' Training Camp Activities, in order that interest in sports might be maintained in army camps. The Red Cross was not entirely overlooked; one day was set apart for special tournaments to be played in every club in the land in aid of this splendid organization.

With the sudden cessation of war came the realization that 1919 would witness a great year in tennis. To the many new figures added to the tennis world in 1918, would come the old champions back from the war. Interest in the game had been increased, thanks to the wise administration of those remaining at home, and all present indications are that 1919 will become, in point of numbers, the greatest year in the history of the game. It will be intensely interesting to witness the coming struggle between the old forces and the new. Which will conquer? Will Williams and Johnston meet in the finals once more? Will McLoughlin compete or will Tilden triumph over the old first ten men? All await the result with the keenest expectation. We are indeed fortunate to have lost no Wilding in this war, and with the present undoubted upward trend of tennis we should be well equipped in another year to wrest the Davis Cup from Australasia. All efforts in 1919 must bend toward this object.

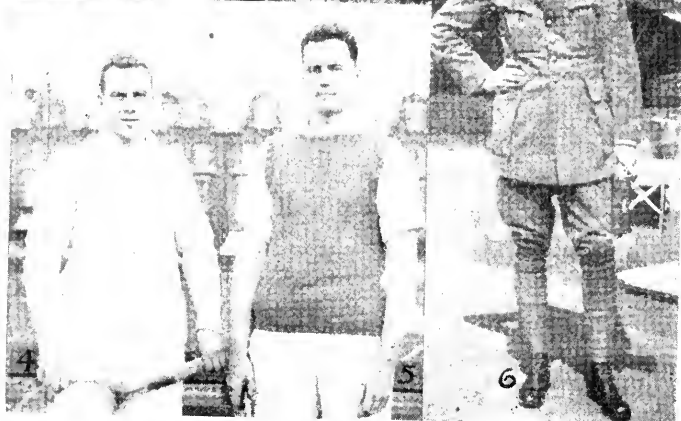

1. Capt. Wallis Myers, Tennis Editor "London Field"; 2. Capt. Guest; 3. Major William A. Larned, U.S.A.—At Bushey Heath, London. 4. Lieut. Francis T. Hunter, U.S.N.; 5. Ensign Clifton B. Herd, U.S.N.—At Queen's Club, London. 6. Lieut. A. H. Gobert, Aviation, French Davis Cup player on leave at the "Bean Site," Cannes, France.

## Lawn Tennis in England

BY SAMUEL HARDY.

At the outbreak of the war, all tournaments were cancelled and practically every able-bodied tennis player in the country entered the service. Those few who were rejected because of disability, entered Government service in some capacity and in their leisure moments naturally turned to their favorite sport.

Public feeling at this time was so strongly opposed to sport of any description, that many a player felt constrained to slink along the street with his racket carefully tucked under his coat, so that he might escape the vigilant eye of some patriotic female who would very likely ask him why he was content to play such a silly game when he might be earning the King's shilling.

While the spirit of the country was, wisely or unwisely, against tournaments, there was much tennis played in an unobtrusive way. Of all England's standard games, none is so economical of both time and space, and many a busy man is indebted to the game for needed exercise otherwise unprocurable. Hard courts require little attention, and as for grass, the courts were there when the players had leisure, and what was a bunker more or less in war time?

The famous All England Club at Wimbledon kept a few grass courts going during the season, as did most of the clubs throughout the country; but the bulk of the play was at Queen's Club, London. Officers returning from the front on leave found themselves welcome, whatever their nationality, and kept themselves fit by play either indoors or on grass. It was not long, therefore, before Government officials began to look upon tennis more favorably, some of them even proclaiming it an admirable war game.

Among those who kept alive the spirit of tennis, there was no more faithful worker than George Caridia, who assumed the heavy duties of honorable secretary of the All England Club in place of George Hillyard, who, with his son, had entered the army at the outbreak of hostilities. Ritchie, Gore, Barrett and Dixon, all old Davis Cup men, played as often as occasion permitted, while Davson, Queen's Club champion, Greville, Simond, Fowler, Myers, Watt and others lent their service in exhibition matches played for patriotic purposes.

Quite the most important tennis meeting during the war was held at Queen's Club on August 25, 1918. W. A. Larned heading several noted American players. It was a Red Cross affair, Army versus Navy, and it was attended by many eminent men, including Admiral Sims and General Biddle.

The Army won by five matches to four, but the heroes of the day were a young Navy pair from this country—Ensign Clifton B. Herd and Lieutenant Francis T. Hunter—who won all three of their matches, impressing the critics most favorably. The *Times* speaks of them, and of Lieutenant P. H. Glover, R.N., as "young players of the highest promise, who might in the future aspire to championship honors." The countries represented in the play were England, Australia, South Africa, Canada and the United States.

The Navy team included besides Hunter, Herd and Glover, Staff Surgeon Grieg, Lieutenant Gordon Cleather and Lieutenant P. M. Davson, while Major Arthur H. Lowe joined Larned in the doubles for the Army side, which also comprised Colonel H. G. Mayes of the Canadian Davis Cup team of 1913; Colonel A. R. F. Kingscote, a member of Britain's team in 1914; Captain C. C. Le Sueur of South Africa, and P. O'Hara Wood of Australia.



COL. WAIT C. JOHNSON.

Member of the General Staff and Chief Intelligence Officer of the A.E.F.

## American Officers' A. E. F. Championships Cannes, France

BY HARRY L. GRAFF.

Before describing the most remarkable and what a great many consider the greatest tennis tournament ever played, namely, the American officers' tennis tournament for the championship of the A.E.F., which started February 19, 1919, at Cannes, France, it will be necessary for me to explain how it became possible to get the pick of the players and assemble them at the same time at this famous spot on the Riviera.

Immediately after the signing of the armistice on November 11, it became a great problem to the General Staff as to just how they were going to handle over 2,000,000 American soldiers and officers, who before the armistice were constantly keyed up to a high pitch by continuous fighting, drilling, and with the one idea in every man's mind of "lick the Hun." Naturally enough, immediately after the signing of the armistice, the reaction set in—the men became fretful, the tremendous routine of continuous drill and preparation was no longer necessary, and while before the boys were only too glad to work themselves to a finish, now everything of this nature became hateful to them.

Fighting having stopped entirely and, due to the above condition, military maneuvers having been reduced to a few hours each day, the question arose, What are we going to do with this idle time and at the same time keep the men fit and their minds busy?

Into this breach stepped the man of the hour in France, Colonel Wait C. Johnson, one of the General Staff and Chief Intelligence Officer of the Army. He had been studying this question for a long time before the armistice in anticipation of just such a state of affairs, and when the time came he was there with the most ambitious and comprehensive programme of athletics probably ever formulated. This programme was so enormous that every man in the A.E.F. physically fit was to be busy at some kind of play. When this plan was submitted to General Pershing, he unqualifiedly approved of same and immediately appointed Colonel Johnson chief athletic officer of the A.E.F., with instructions to put it through in conjunction with the Y.M.C.A. athletic department.

Immediately thereafter Colonel Johnson met with the Y.M.C.A. athletic directors at Tremblay and outlined his plans. Of the 125 present, all trained experts in athletics and numbering in their midst some of the greatest athletes we have ever had, each and every one signified his willingness to do his utmost in putting over this programme. One of the first events to be decided was the officers' tennis championship.

In the Army of Occupation and intermediate sector, each division was to be represented by four players, two from each corps and each army headquarters. The S.O.S. was divided into areas, each area being allowed four representatives, with two for each headquarters.

Where weather permitted, players were selected by elimination, otherwise by selection. The eliminations and selections took place the latter part of January and orders were sent from General Headquarters at Chaumont to each unit ordering the successful candidates to report at Cannes by February 16. Needless to say, only death itself could prevent the men from obeying this order.



On the extreme right, in the act of taking a cigar from his mouth, is Major William A. Larned. Next to him is Capt. Devereux Milburn, and on Capt. Milburn's right, with his face turned away, is Capt. George A. Lyon. Seated, with the riding crop, is Lieut. Stacy Brown, a skillful young player from Harvard and a bearer of the Croix de Guerre.

GROUP OF AMERICAN OFFICERS WATCHING THE PLAY AT CANNES, FRANCE.



Cannes, the Pearl of the Riviera, was selected as the setting for this famous tournament on account of its beauty, wonderful climate, elegance and aristocratic grace, the magnificent Hotel Carlton, and last, but not least, its two famous tennis clubs, the Carlton and Cannes, the object being to divert the minds of the men entirely from the past few months and take them into another world—a world of beauty and pleasure.

The writer, who was the "Y" athletic director attached to Colonel Johnson as his aide to do the actual handling of the tournament, was ordered to Cannes, arriving there on February 9.

Arrangements were made for the accommodation of all officers at the Carlton Hotel, and the Carlton and Cannes clubs immediately offered their beautiful courts, numbering thirteen in all, for practice purposes and for the actual conduct of the tournament. The Red Cross and the Y.M.C.A., controlling five more courts between them, also offered theirs.

These offers were accepted, and as arrangements already had been completed for Spalding (who I might state right here went out of their way to do everything to help us out) to open a fully equipped tennis store in Cannes, everything was in readiness by the time the first of the players arrived.

The arrivals began on February 12 and continued steadily until February 16, when 188 entries were recorded, representing forty-four States, the majority players of note from their respective States and organizations and numbering in their midst such well known players of national and international reputation as Williams, Larned, Davis, Wrenn, Washburn, Mathey, Breck and Watters.

Practice naturally started as soon as the men began to arrive, but by February 16, due to the large entry list and the limited number of courts, it became necessary to issue orders for practice. This gave each man a specified court and hour each day, with no advantage to anyone, and the practice programme was so worked out that men who were entered together in the doubles were placed together during practice periods.

From the writer's viewpoint it was most remarkable with what rapidity these men, who had not handled a racket in from one to three years, began rounding into form. Of course, the first day they were very careful; but by the third day they were using the severe service, putting the real sting into the ball on their ground strokes, and by the 19th everyone had his eye on the ball.

It must be mentioned here that as soon as the public got the news through the press that Cannes was the favored spot, the hotels began to fill with notables of all nationalities, including a great many English, Canadian and Australian officers, who were well repaid for their long journey.

On February 19, sharp at 9 A. M., the singles began, Colonel Johnson acting as manager of the Carlton Club, and the writer in the same capacity at the Cannes Club. There also was an umpire for each court. Orders were issued the night before to the effect that all officers must report *on time* for their matches. The matches were run off with precision and with no unnecessary delay, and at five o'clock, when the results were posted in the tennis office at the hotel, it was found that, as planned, we had disposed of ninety-four matches.

That evening at the dance given by the Y.M.C.A. Officers' Club, the men began to realize that they were really going to have a wonderful time. Not only were they enjoying themselves at their favorite game on magnificent courts, but they had scores of real pretty American girls to dance with. As Colonel Johnson had made the statement that the tournament would be played



MAJOR BERNON S. PRENTICE,  
New York.

Deputy Commissioner of the American Red Cross for France; Organizer of American Red Cross Ambulance Service in Italy; Italian War Cross Campaign Medal; Officer of the Crown of Italy.

off in good weather and on dry courts if it took a year to do it, the desire for rain became very pronounced, and the weather man being a good fellow for the time being, rain it did for two solid days, with the players improving their footwork on the polished hardwood floor of the club with the assistance of two military bands.

Play was again resumed on Washington's Birthday, the thirteen courts of the two clubs being used. Forty-seven matches were played, which brought us into the third round.

With close attention to the play and form displayed, it became quite evident that, barring reversal, Williams, Washburn, Mathey, Breck, Watters, Davis, Dell, Payne and Van Deventer would be fighting it out for premier honors.

H. C. Breck sprung a surprise on those who had never seen him play by his defeat of Douglas Watters, the Southern champion, and from then on he was looked upon by many as the dark horse. He next disposed of Colonel Dwight F. Davis, who had been playing remarkably good tennis, but whose backcourt game could not stand against the net play of this Californian.

However, he met his Waterloo at the hands of R. Norris Williams, 2d, after a spirited match.

Mathey, who had been playing excellent tennis, was figured to give Washburn a hard tussle. Mathey elected to take the net and Washburn, whose whip stroke was working perfectly, was content to play the back court. His judgment proved to be correct, as he was constantly able to pass Mathey on the side lines, breaking his game all up and winning in straight sets.

The Van Deventer-Dell match went the full limit before Van Deventer finally pulled out the winner.

Payne having disposed of Larned, in his following match with Washburn decided to play him at his own game—the base line—and consequently this match was one of the best, from the spectators' point of view, in the whole tournament. For a short time it looked as though Washburn was going to have his hands full to come out on the winning end, but his wonderful and continued sureness of stroke finally upset Payne and he came through to victory.

This brought Williams and Washburn into the final. In this match Williams played such a diversified game, with so many changes of pace, that he upset Washburn's game completely and won in straight sets. In the doubles, Williams and Washburn, who were teamed together, came through without being extended.

Cups were presented to the winners and runners-up by the Y.M.C.A., and Williams was presented with a beautiful trophy by the City of Cannes.

Play was finished on March 3, and on the 4th everyone started on the return journey to their organizations, the consensus of opinion being, as the majority expressed it, "We had the best time of our lives."

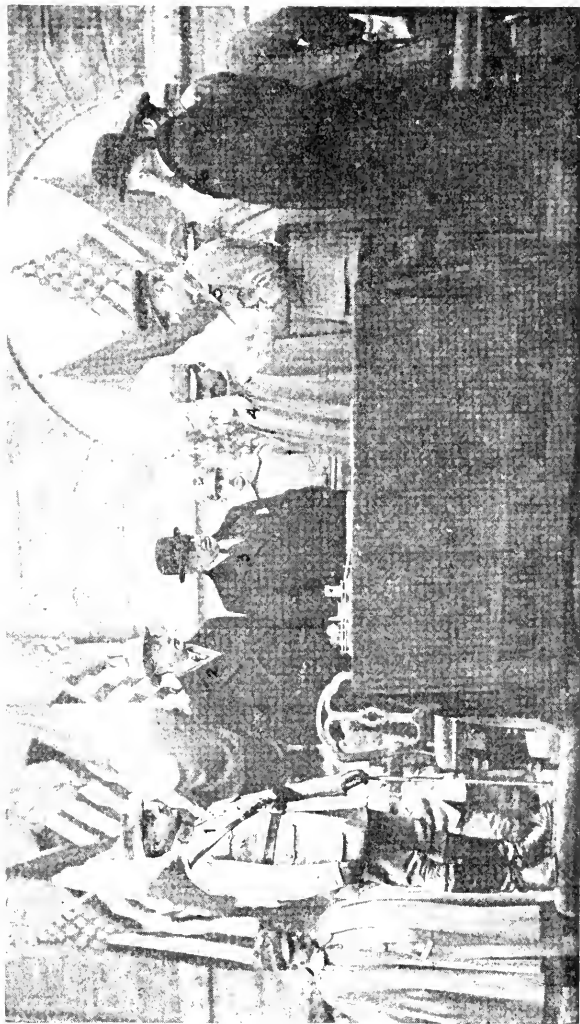

1, Commandant Fisher of French Base; 2, North Winship, American Consul at Milan; 3, Prefect of Milan; 4, General Castadello; 5, Bernon S. Prentice; 6, Mayor of Milan.

PRESENTATION OF AMBULANCE SERVICE TO ITALIAN ARMY, DECEMBER, 1917, BY MAJOR BERNON S. PRENTICE, ORGANIZER AND DIRECTOR OF THIS SERVICE FOR THE AMERICAN RED CROSS.

## Publicity for Tennis Tournaments

By E. B. Moss,

President National Association of Lawn Tennis Writers.

While tennis is played in all parts of the country and may be considered one of America's major sports, there are still sections where judicious publicity will materially advance the interest in and of the game.

The work involved is not necessarily arduous, but it requires a carefully planned campaign, with co-operation among members of various clubs within a given area. Where several clubs combine in such a project and plan tournaments for club members and interclub matches for various classes, interest can be quickly aroused and sustained throughout the entire season.

Such a plan will provide the material for a publicity campaign. The next step requires the appointment of at least one member in each club who will devote an occasional hour during the week to preparing matter for distribution among the local newspapers. The following suggestions are offered in this connection with the idea of simplifying this work and bringing about co-operation between the club publicity member and the newspapers.

Before sending copy to the newspapers, it has proved a good plan to canvass local publications and ascertain which day of the week is the most suitable for publication. As a rule, it will be found that morning papers will have more space available on the sport page on Monday. Evening papers will generally use such matter on either Saturday or Monday.

Copy should be neatly typewritten on one side of the sheet only, in direct and concise form. Advance notices of tournaments giving the conditions of play, names of members to compete, their handicaps, time and place of matches, arrangement for accommodating spectators, etc., will find ready acceptance. The result of such contests, with scores and an occasional description of the feature matches, can be used as a follow-up. Similar methods can be used for the distribution of club tennis news, such as elections, increase in membership, etc.

It is advisable, although not necessary, to have a distinctive envelope and papers for this weekly copy, which should be addressed to the sport editor of the different papers by name. After a short time he will, as a rule, look for the weekly contribution and reserve space for the same. Different stories should be sent to morning and afternoon papers in order that there may not be a reprint of identical matter in editions within the same twenty-four hours.

These suggestions are intended to merely outline the methods whereby much desirable publicity may be secured and must be changed according to the requirements or other conditions of any given locality. While it is generally the case that all tournaments for local championships or matches of equal importance are covered by regular assigned reporters, the time of these writers is, as a rule, considered too valuable to permit their making daily or weekly rounds of the tennis clubs for the more prosaic but none the less interesting matter which is always available.

In sending the accounts of matches to the papers, be sure to include the names of those who serve in various official capacities at a match, such as umpire, linesmen, etc. Competent officials are a big factor in the success of any tournament and the publication of their names will be an act of courtesy on the part of the management in recognition for their services.



CHARLES S. GARLAND,  
Pittsburgh, Pa.  
United States Clay Court Doubles Champion, 1918.

# Handicap Tournaments Provide Close Matches

BY SAMUEL HARDY.

In the handicap tournament, the "dub" comes into his own; he is placed on an equality with the club champion if both are correctly handicapped, and has an even chance of winning. The better player also benefits, as the advantage of careful play is brought home to him.

Anyone can learn in a very few minutes how to handicap a tournament and how to score a handicap match. It is the purpose of this article to show that the novice need fear no such expressions as "owe half thirty" or "plus 2/6."

Modern handicapping consists of one or more points either received or owed in each six games played, and are designated as + (received) or - (owed). We will first deal with the received odds, and assume that A, the stronger player, gives B, the weaker, a handicap of 15. This means that B receives one point, the first in each game, and has one point less to make than his opponent. If A were serving, the score at the beginning of the game would be love-15, but he would start serving from the right-hand court as usual. Now suppose that A finds that he cannot give B so large a handicap; what shall he do? The "Sixths System" of handicapping was devised to take care of just such a case. Instead of giving a point (15) every game, he may give it in only five out of six games (5/6), or in four games out of six (4/6), and so on down to one game in every six (1/6).

| RECEIVED ODDS. | 1st Game. | 2d Game. | 3d Game. | 4th Game. | 5th Game. | 6th Game. |
|----------------|-----------|----------|----------|-----------|-----------|-----------|
| 1-6 of 15..... | 0         | 15       | 0        | 0         | 0         | 0         |
| 2-6 of 15..... | 0         | 15       | 0        | 15        | 0         | 0         |
| 3-6 of 15..... | 0         | 15       | 0        | 15        | 0         | 15        |
| 4-6 of 15..... | 0         | 15       | 0        | 15        | 15        | 15        |
| 5-6 of 15..... | 0         | 15       | 15       | 15        | 15        | 15        |

The accompanying schedule of received odds shows just when these points are to be taken. Note that a player receiving 1/6 always takes the point at the beginning of the second of each series of six games, or, in other words, on the second, eighth, fourteenth, etc., games of the set, and that if he receives 2/6 he takes the points in the second and fourth games of each six. A handicap of 3/6 is known as "half 15," one point being taken every alternate game. "Half 30" means 15 received in the first game, 30 in the second, 15 in the third, 30 in the fourth, and so on. "Half 40" means 30 in the first game, 40 in the next, and so on.

When A is so far the superior of B that he can give him 30 and still win comfortably, B's handicap is not increased to "half 40" or to 40, as B might then win a game by getting a single point. Instead, A is placed below scratch and must win one or more extra points before he arrives at scratch, while B still has two points to make. For example, if A, serving to B, owes 15 and gives 30, the score prior to the play is "owe 15, 30," but if B serves it is "30, owe 15." Should A, serving, win the first point, the score is "love, 30," and he has made up what he owes. If A loses the first point the score is "owe 15, 40."

It was found that when B received a handicap greater than 30, luck played too prominent a part in the game, since a single bad bounce, a net cord, or a fluke won too many games. Odds of 40 are too discouraging to the average good player, who is then obliged to play too cautiously to enjoy the match. This is not the case when he *owes* odds, for while he has more points to make to score a game, his opponent must always make at least two points.

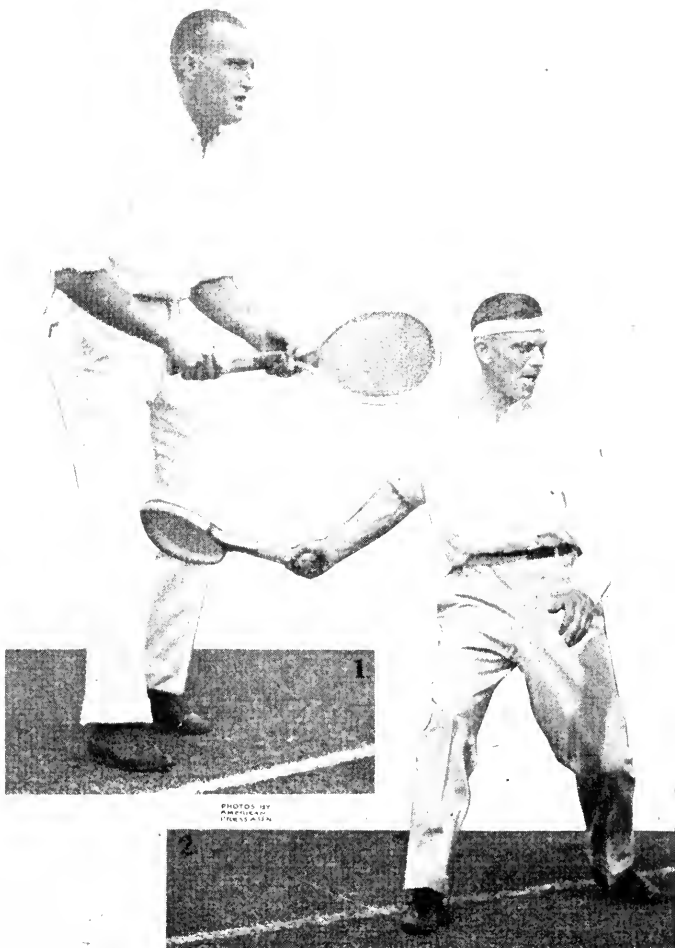

THEODORE R. PELL,  
New York.

KARL H. BEHR,  
New York.

PHOTOS BY  
AMERICAN  
PRESS-ATLANTA



| OWED ODDS.     | 1st Game. | 2d Game. | 3d Game. | 4th Game. | 5th Game. | 6th Game. |
|----------------|-----------|----------|----------|-----------|-----------|-----------|
| 1-6 of 15..... | 15        | 0        | 0        | 0         | 0         | 0         |
| 2-6 of 15..... | 15        | 0        | 15       | 0         | 0         | 0         |
| 3-6 of 15..... | 15        | 0        | 15       | 0         | 15        | 0         |
| 4-6 of 15..... | 15        | 0        | 15       | 0         | 15        | 15        |
| 5-6 of 15..... | 15        | 0        | 15       | 15        | 15        | 15        |

An important point to note is that *fractional* owed odds begin in the first game, never in the second. Owed odds may be divided into sixths in exactly the same manner as received odds. If A owes B 1/6 he must win one extra point in every six games. In other words, he "owes" this point, which, as the schedule shows, is owed only in the first game. The score at the beginning of the first, seventh and thirteenth games, A serving, is "owe 15. love," but at the commencement of all other games is "love-all." If A owes 15 1/6, he is "owe 15" in every game except the first, seventh and thirteenth, when he is "owe 30." If he owes 15 3/6, he owes 30 in three games (the first, the third and the fifth) and 15 in the other three games.

When two players are matched, each receiving odds, there are two systems by which their handicaps may be arranged. In one, the Direct Method, the better player starts at scratch, giving the poorer the difference between the two handicaps. For example, C + 2/6 is opposed to D + 5/6. C goes to scratch, giving D 3/6. The other system is known as the Differential and is printed on page 265. See table No. 1. Here, too, the better man plays at scratch, but the handicap of his opponent is determined in quite another way. Suppose A + 15 plays B + 30, A does not give B 15, but 15.1, as the table shows. Look along the top column from left to right until you come to the handicap for which you are looking, which in this case is 15, and comes in column 6. Now drop your eye down to the bottom of column 6 and run along to the right until you come to the column of which 30, your other handicap, is the head, namely, column 12. At the intersection of the two columns the figures 15.1 are printed, and this is the handicap A gives B. The Sixths System is followed, so 15.1 means 15 and one-sixth, not 15 and one-tenth as in the decimal system.

Owed odds may also be figured by either system. In the Direct Method, when two players owe odds, the one owing the lesser odds advances to scratch, his opponent owing him the difference between the two handicaps. For instance, if E, "owe 15," plays F, "owe 2/6," F plays at scratch, and E owes 4/6. Table No. 2 on page 266 shows how the owed odds are figured according to the Differential System. Follow the same method as when determining the handicap in received odds. For instance, if E, "owe 15," plays F, "owe 2/6," find the column headed by the smaller odds, 2/6, which is column 2. Follow along the bottom of this to the right until you reach the "owe 15" column (No. 6) and at the intersection of the two columns is the odds E owes F, or 3/6 of 15.

Handicapping must be left to the discretion of the club's handicap committee. Mistakes are bound to occur at the first attempt, but one or two trials produce many close matches. Start with your poorest player, placing him at plus 30, and work toward scratch by sixths, giving the next best player 15 5/6, the next 15 4/6, and so on. Usually your Class B man plays at or near scratch, only the Class A man owing odds. Do not hesitate to place a really good player far below scratch, say "owe 30" or "owe 40," and sometimes even lower.

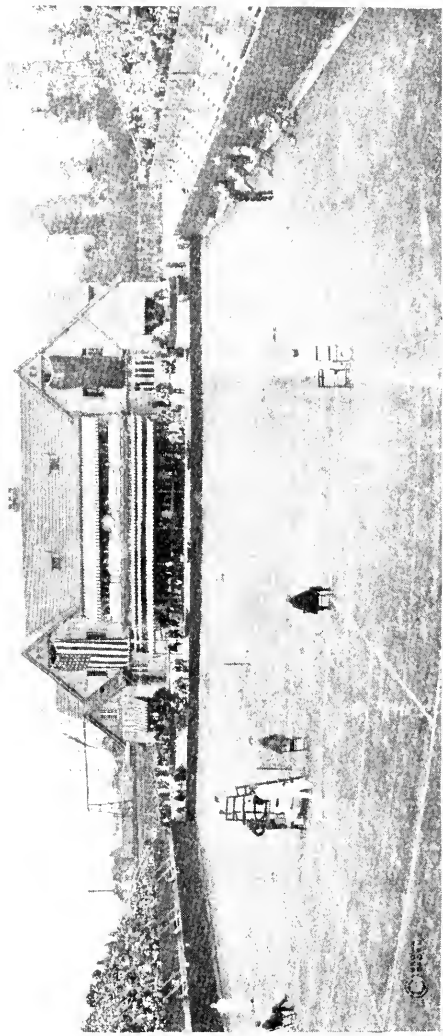

WEST SIDE TENNIS CLUB, FOREST HILLS, L. I., N. Y.

© 1917

## National Championships

After a lapse of one year—in which a patriotic tournament but no championship was scheduled—the annual competition for the singles championship of the United States, the thirty-seventh under the auspices of the U.S.N.L.T.A., was held on the courts of the West Side Tennis Club, Forest Hills, Long Island, during the period August 26 to September 3, inclusive.

The interval of a year had given the Association a chance to get a focus on the tennis situation in general, and it was the consensus of all concerned—in which was included the viewpoint of the crack players who had joined the colors—that it would be for the best interests of the game to resume the competition for the national championship.

Eighty-seven entrants were scheduled to compete and the quality of players compared favorably with the class that had competed in pre-war times.

The first round went through the usual elimination incident to initial play, with no upsets of importance. The feature of the first day's play was an extraordinarily long contest between Harold Throckmorton and Harold Taylor,

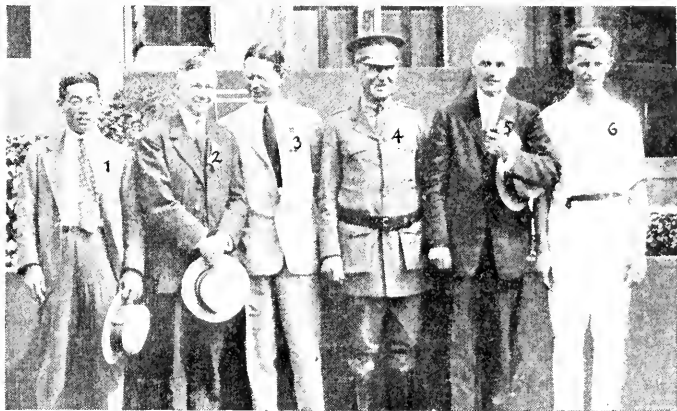

1, Ichiya Kumagai; 2, Julian S. Myrick; 3, Dr. Joseph E. Rayeroft; 4, Walter Camp; 5, Edwin F. Torrey; 6, R. Lindley Murray.

Photo © by Corte-Scope Co., Cleveland, O.

the Brooklyn lad, which the former won in the fifth set. The match took eighty-three games, totaling 503 points, of which Throckmorton got 261 and Taylor 242. Throckmorton won 43 games to Taylor's 39. The former "record" for a lengthy contest was in the match between Palmer E. Presbrey and T. Suffern Tailer, which took place at Newport in 1880, eighty games being played before the former won.

Other winners in the first day's play included F. B. Alexander, F. C. Baggs, T. R. Pell, Beals Wright, Nat Niles, and other prominent contestants in championships.

The second day's play included another "marathon" or endurance test, this time the Japanese player Seiichiro Kashio and G. A. L. Dionne stringing out

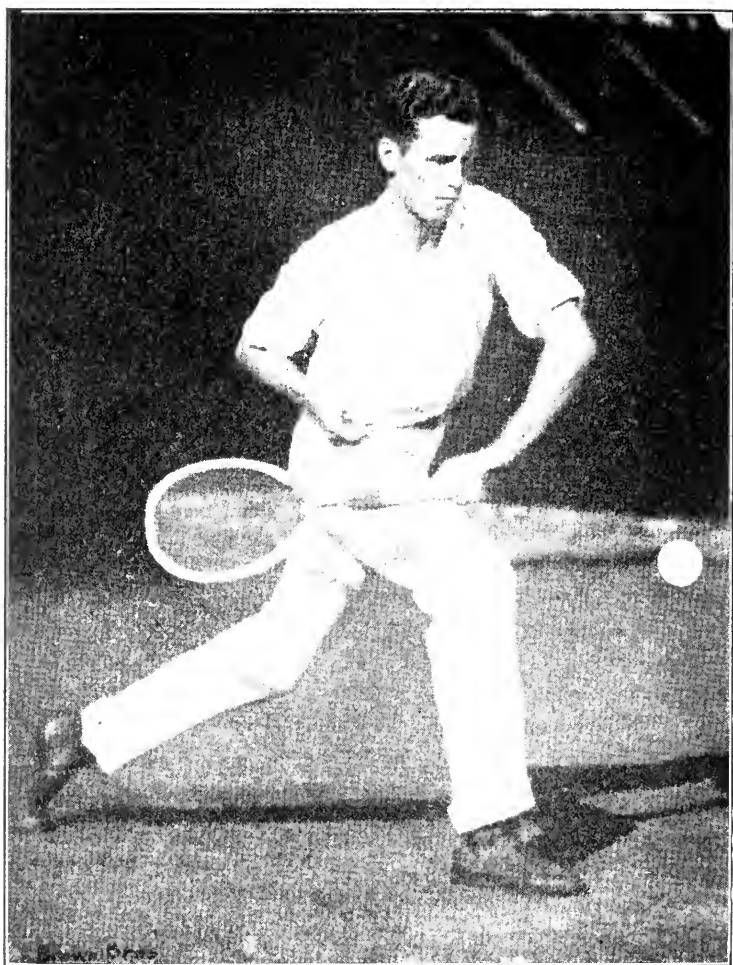

R. LINDLEY MURRAY,  
Niagara Falls, N. Y.; National Champion, 1918.

their match until stopped by darkness, with the score 6/1,7/9,6/3,2/2. This event consumed over four hours of time and the patience of the spectators. In some of the rallies the ball went over the net more than one hundred times before a point was scored.

There were no outstanding features of play in the second round and as eliminations continued the class of the tournament began to emerge, furnishing a topic of discussion as to the chances of the various players and their eventual rating.

The "to be continued in our next" match of Kashio and Dionne was quickly settled on the third day in favor of the Japanese, and the latter, now imbued with long distance propensities, extended Lyle Mahan in another long drawn out affair, darkness again intervening with the score in favor of Kashio, 10/8,10/8,6/8,6/6.

Some surprises were uncovered in this round. Murray, who had practiced very little all year, defeated Pell handily in straight sets. Walter Merrill Hall took the measure of Walter T. Hayes, the Western crack. The latter's partner, Ralph Burdick, was the victim of Nat Niles, and Tilden defeated Conrad B. Doyle of Washington. F. B. Alexander and Harold Throckmorton furnished the feature match of the day. The former internationalist started slowly, while his young opponent showed some of the most brilliant tennis of his career. Alexander, however, began to pick up in the third set and won it and the succeeding two in true Alexander style.

Thursday's play found Murray as the opponent of Alexander, and the exhibition that these two masters of the racket gave, set the crowd wild as one brilliant play succeeded another. Although the match required five sets for a decision, it was apparent nevertheless that Murray never was in real danger and he finished the match with a dazzling display, taking six games straight. This was the second best match of the tournament.

Merrill Hall opposed Tilden, who had as yet been unbeaten during the grass season. He had the Philadelphia player in a hole, 6/3,1/6,7/5,3/2, when a torrential rainstorm postponed the match. At the same time, on another court, Beals Wright was leading the famous Kumagae, 9/8, when the elements intervened.

The following day, Friday, found Wright and Kumagae continuing their left-over match. The veteran Davis Cup player carried the Japanese to five sets, but the latter was not to be denied, and won, 8/10,6/3,3/6,6/1,6/2. Hall and Tilden also resumed their match. The respite had a good effect on Tilden, who, despite the load that Hall had hung upon him, finally won, the score being 3/6,6/1,5/7,7/5,6/1.

The Murray-Niles match was a pretty one, but, as in the case of Murray's other opponents, had the inevitable result. Niles had a chance to go to five sets, but lost the opportunity with an easy ball into the net.

Two matches only were scheduled on Saturday. Kumagae disposed of Lyle Mahan, while Murray and Voshell—both left-handers—had it out in a stubborn contest, the former winning, 6/4,6/3,8/6.

The semi-final between Tilden and Kumagae was played on Labor Day before a fine crowd, which included a large number of the Japanese player's countrymen. It took only forty-four minutes for Tilden to defeat his opponent, a remarkably short period of time for a national semi-final event, the score being 6/2,6/2,6/0. Despite the encouraging presence of his fellow Nipponese, Kumagae seemed helpless before the onslaught of his rival, who played a match that was perfect both as to form and tactics.

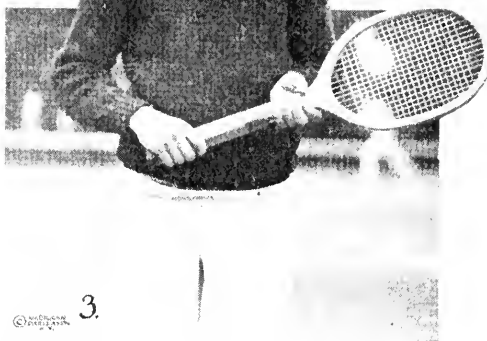

DEAN MATHEY,  
Cranford, N. J.

GEORGE M. CHURCH,  
Tenafly, N. J.

FRED C. INMAN,  
New York.

September 3 saw a new champion in the person of R. Lindley Murray, the young chemist of Niagara Falls and California, who, in three sets, administered the first defeat of the season to William T. Tilden, Jr., of Philadelphia. The latter, on the form shown during the summer, was generally conceded to have the best chance for the championship. Murray had been defeated by Tilden at Southampton the previous week and needed the period of the championship to tune him up for his final effort. Tilden suffered severely from a boil that had developed on his foot on the last day and was not able to withstand the characteristic fast attacking game of Murray, who was now at the pinnacle of his ability. Tilden fell a victim in three straight sets which took only an hour to play. The point score:

|        | First Set.  |   |   |   |   |   | N. | O.  | P.   | S.A. | D.F. |     |   |    |   |    |   |   |
|--------|-------------|---|---|---|---|---|----|-----|------|------|------|-----|---|----|---|----|---|---|
| Murray | 4           | 4 | 6 | 0 | 4 | 4 | 4  | —35 | 6    | 8    | 4    | 10  | 1 | 3  |   |    |   |   |
| Tilden | 1           | 1 | 4 | 4 | 1 | 6 | 3  | 6   | 0—26 | 12   | 12   | 11  | 0 | 0  |   |    |   |   |
|        | Second Set. |   |   |   |   |   | N. | O.  | P.   | S.A. | D.F. |     |   |    |   |    |   |   |
| Murray | 4           | 4 | 4 | 4 | 0 | 4 | 4  | —24 | 6    | 1    | 6    | 8   | 6 | 0  |   |    |   |   |
| Tilden | 2           | 0 | 2 | 2 | 4 | 1 | 2  | —13 | 1    | 2    | 6    | 4   | 2 | 2  |   |    |   |   |
|        | Third Set.  |   |   |   |   |   | N. | O.  | P.   | S.A. | D.F. |     |   |    |   |    |   |   |
| Murray | 4           | 1 | 5 | 5 | 4 | 1 | 4  | 2   | 0    | 0    | 4    | —34 | 7 | 5  | 8 | 8  | 5 | 2 |
| Tilden | 1           | 4 | 3 | 3 | 0 | 4 | 2  | 4   | 4    | 4    | 0    | —31 | 5 | 12 | 8 | 14 | 2 | 1 |

RECAPITULATION.

|        | Games. | Sets. | Points. | Nets. | Outs. | Pl. | S.A. | DF. |
|--------|--------|-------|---------|-------|-------|-----|------|-----|
| Murray | 19     | 3     | 93      | 14    | 18    | 26  | 12   | 5   |
| Tilden | 9      | 0     | 70      | 26    | 26    | 29  | 4    | 3   |

The proceeds of the championship, over \$8,000 net, were turned over to the War Department's Commission on Training Camp Activities.

NATIONAL CHAMPIONSHIP SINGLES.

FIRST ROUND.

| Winner.                | Score.                     | Opponent.         | Winner.           | Score.                    | Opponent.           |
|------------------------|----------------------------|-------------------|-------------------|---------------------------|---------------------|
| Nathaniel W. Niles     | 6/2, 6/0, 6/1              | H. W. Hane        | R. Wabraushek     | 6/4, 6/2, 6/2             | George S. Groesbeck |
| W. J. Gallon           | 6/0, 3/6, 6/0, 6/3         | R. A. Johnson     | Henry S. Parker   | 6/4, 6/0, 6/1             | Hector R. Burroughs |
| A. H. Chapin, Jr.      | 6/3, 6/4, 6/2              | E. C. Burghard    | Herbert D. Vail   | 6/2, 5/7, 6/1, 13/15, 6/2 | Robert A. Pope      |
| Ralph H. Burdick       | 6/2, 6/4, 6/4              | Herbert L. Bowman | George W. Pike    | 6/1, 6/0, 6/3             | H. V. Miller        |
| Fred B. Alexander, Jr. | 6/0, 6/2, 6/2              | George O. Wagner  | Lyle E. Mahan     | 6/1, 6/3, 6/3             | Sgt. Alex. Gravem   |
| A. H. Chapin, Sr.      | 6/2, 6/1, 6/3              | Eugene I. Czintz  | Henry B. O'Boyle  | 6/1, 3/6, 3/6, 6/1, 6/4   | E. F. Thomas        |
| Fred C. Baggs          | 6/1, 6/1, 6/4              | Lt. E. P. Larned  | Seiichiro Kashio  | 6/3, 7/5, 6/1             | Fred C. Anderson    |
| H. A. Throckmorton     | 6/8, 6/2, 11/9, 7/9, 13/11 | Harold L. Taylor  | G. A. L. Dionne   | 6/0, 6/2, 6/0             | Frank A. Fall       |
| Theodore R. Pell       | 6/2, 6/2, 6/3              | J. B. Hughes      | Dr. B. F. Drake   | 6/2, 6/3, 6/4             | Percy L. Kynaston   |
| Russell N. Dana        | 6/2, 6/3, 6/0              | Alex. Her         | Beals C. Wright   | default                   | Robert L. James     |
| R. Lindley Murray      | 6/0, 6/0, 6/1              | Jack Dudley       | Lt. L. F. Gilbert | 6/0, 6/1, 6/0             | Augustin Healy      |
| Lt. H. G. M. Kelleher  | 0/6, 6/4, 6/4, 7/5         | J. W. Anderson    |                   |                           |                     |



1. Willis E. Davis, San Francisco. 2. L. H. Waldner, Chicago. 3. Leonard Reekman, Manager Princeton tennis team. 4. Fred H. Harris, Brattleboro, Vt



SECOND ROUND.

| Winner.                   | Score.                    | Opponent.               | Winner.             | Score.                   | Opponent.             |
|---------------------------|---------------------------|-------------------------|---------------------|--------------------------|-----------------------|
| Lt. Craig Biddle          | 6/2, 6/4, 6/2             | James D. Ewing          | Parker              | 6/0, 6/2, 6/1            | Wabraushek            |
| A. S. Cassils             | 6/1, 6/3, 6/4             | J. S. O'Boyle           | Pike                | 11/9, 6/0, 6/4           | Vail                  |
| Dr. H. J. K. Morgenthaler | 6/1, 6/4, 6/2             | J. P. Stockton          | Mahan               | 6/0, 7/5, 7/5            | H. B. O'Boyle         |
| Edward C. Simmons         | default                   | Dr. Wm. Rosenbaum       | Kashio              | 6/1, 7/9, 6/3, 7/5       | Dionne                |
| Lt. S. H. Voshell         | 6/0, 6/1, 6/3             | Royal D. Richey         | B. C. Wright        | 6/0, 6/0, 6/2            | Drake                 |
| Harold D. Bretz           | default                   | Theodore G. Fulton      | Lindsay Dunham      | 7/5, 6/2, 6/3            | Gilbert               |
| Vincent Richards          | default                   | Cadet R. F. Nathan, Jr. | Ichiya Kumagae      | 6/0, 6/4, 6/0            | Walter L. Pate        |
| Frank T. Anderson         | 6/3, 6/4, 2/6, 6/1        | H. D. Keresey           | George W. Wightman  | 6/2, 3/6, 6/3, 6/4       | W. J. Whelan          |
| Ralph P. Gatecomb         | 2/6, 6/2, 6/0, 13/15, 6/2 | Gerald B. Emerson       | George King         | 4/6, 11/9, 7/5, 0/6, 6/3 | Henry Bassford        |
| E. H. Binzen              | 6/1, 6/3, 6/2             | Fred T. Fox             | Conrad B. Doyle     | 6/1, 6/2, 6/2            | Lt. Wm. A. Horrell    |
| Niles                     | 6/1, 6/4, 6/2             | Gallon                  | Channing G. Burrows | 6/2, 6/3, 9/7            | Arthur Neilsen        |
| Burdick                   | 6/3, 6/1, 6/1             | A. H. Chapin, Jr.       | W. T. Tilden, Jr.   | default                  | Paul W. Gibbons       |
| Alexander                 | 6/2, 6/2, 6/1             | A. H. Chapin, Sr.       | Walter T. Hayes     | 6/2, 6/2, 6/2            | E. B. Cumming         |
| Throckmorton              | 6/4, 6/2, 3/6, 7/6        | Baggs                   | E. H. Hendrickson   | 6/2, 6/3, 7/5            | Allan H. Behr         |
| Pell                      | 2/6, 6/3, 6/2, 6/3        | Dana                    | Irving C. Wright    | 6/1, 6/0, 6/2            | W. J. Kaltenbach, Jr. |
| Murray                    | default                   | Kelleher                | Walter M. Hall      | 6/0, 6/1, 6/3            | Cecil Donaldson       |

THIRD ROUND.

|              |                         |              |              |                    |              |
|--------------|-------------------------|--------------|--------------|--------------------|--------------|
| Biddle       | 6/0, 6/2, 6/1           | Cassils      | Parker       | 6/3, 6/3, 6/0      | Pike         |
| Morgenthaler | 6/2, 6/1, 6/2           | Simmons      | Mahan        | 8/6, 8/6, 6/8, 8/6 | Kashio       |
| Voshell      | 6/3, 6/0, 6/1           | Bretz        | B. C. Wright | 6/4, 6/2, 6/3      | Dunham       |
| Richards     | 6/1, 6/3, 6/3           | Anderson     | Kumagae      | 6/3, 6/2, 6/2      | Wightman     |
| Binzen       | 6/2, 2/6, 6/1, 6/4      | Gatecomb     | Doyle        | 6/3, 6/3, 6/3      | King         |
| Niles        | 7/5, 6/4, 2/6, 7/5      | Burdick      | Tilden       | 6/1, 6/3, 6/3      | Burrows      |
| Alexander    | 2/6, 3/6, 7/5, 6/0, 6/3 | Throckmorton | Hayes        | 6/1, 6/2, 6/2      | Hendrickson  |
| Murray       | 6/2, 6/0, 6/0           | Pell         | Hall         | 4/6, 7/5, 6/1, 6/2 | J. C. Wright |

FOURTH ROUND.

|         |                         |              |         |                          |              |
|---------|-------------------------|--------------|---------|--------------------------|--------------|
| Biddle  | 6/0, 6/3, 6/3           | Morgenthaler | Mahan   | 6/2, 6/2, 6/3            | Parker       |
| Voshell | 5/7, 4/6, 6/0, 6/2, 7/5 | Richards     | Kumagae | 8/10, 6/3, 3/6, 6/1, 6/2 | B. C. Wright |
| Niles   | 7/5, 6/0, 6/2           | Binzen       | Tilden  | 6/3, 6/1, 7/5            | Doyle        |
| Murray  | 8/6, 8/6, 6/0, 4/6, 6/0 | Alexander    | Hall    | 3/6, 6/4, 0/6, 6/4, 6/4  | Hayes        |

FIFTH ROUND.

|         |                    |        |         |                         |       |
|---------|--------------------|--------|---------|-------------------------|-------|
| Voshell | 6/2, 6/3, 9/7      | Biddle | Kumagae | 4/6, 6/3, 6/0, 6/1      | Mahan |
| Murray  | 7/5, 6/4, 2/6, 7/5 | Niles  | Tilden  | 3/6, 6/1, 5/7, 7/5, 6/1 | Hall  |

SEMI-FINAL ROUND.

|        |               |         |        |               |         |
|--------|---------------|---------|--------|---------------|---------|
| Murray | 6/4, 6/3, 8/6 | Voshell | Tilden | 6/2, 6/2, 6/0 | Kumagae |
|--------|---------------|---------|--------|---------------|---------|

FINAL ROUND.

R. Lindley Murray defeated W. T. Tilden, Jr., 6/3, 6/1, 7/5.

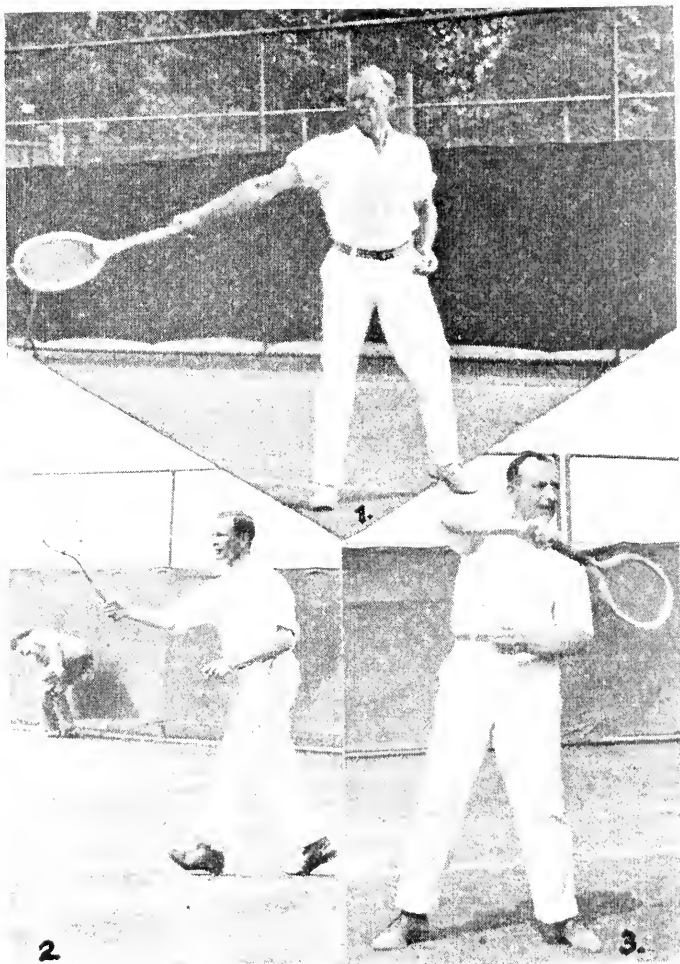

(1) Edwin Sheafe, Boston. (2) Edwin P. Larned, New York. (3) Ross Burchard, winner of the first Veterans' Championship held in conjunction with the National Championship of 1918. Mr. Burchard died suddenly at his home, Norwalk, Conn., on November 15. He was for many years a member of the West Side Tennis Club and won the Metropolitan Championship in 1908.

Photos © by Corte-Scope Co., Cleveland, O.

## Veterans' Championship

The first veterans' championship, held in conjunction with the national championships on the West Side Tennis Club's courts, Forest Hills, L. I., was a pronounced success. There was an entry list of twenty-eight, and many good contests resulted. The honor of winning this new national title fell to the lot of Ross Burchard, long a member of the West Side Tennis Club, and winner of the Metropolitan championship in 1908. He came through to the final round with the loss of but one set, to R. Stevens in the second round, and there met Fred G. Anderson of the Kings County Tennis Club of Brooklyn, N. Y., former Canadian champion, and who stood No. 8 in the 1906 ranking. Neither player put up the game he is capable of in the final, but Burchard proved the steadier and won out. The summaries:

### MEN'S SINGLES.

FIRST ROUND—Dr. W. H. Ross d. M. S. Hager, 3/6,6/3,6/2; Fred G. Anderson d. S. W. Merriliew, 6/0,6/1; Dr. Willard Travell d. G. S. Groesbeck, 6/4,6/8,7/5; Ross Burchard d. Capt. E. W. Hamlen, 6/3,6/0; S. R. McAllister d. W. S. Lacey, 6/2,6/1; Edwin Sheafe d. E. F. Torrey, 6/0,6/2. SECOND ROUND—G. W. Case d. H. W. Warner, 6/4,3/6,6/2; Anderson d. Ross, 8/10,6/3,6/0; W. D. Hadsell d. A. L. Hoskins, 6/2,8/6; Travell d. J. D. E. Jones by default; Dr. W. T. Stephens d. L. H. Rogers, 6/1,6/0; Burchard d. R. Stevens, 6/3,3/6,9/7; Sheafe d. McAllister, 6/4,6/4; C. J. Post, Jr., d. Porter Fitch, 6/3,6/1. THIRD ROUND—Anderson d. Case, 4/6,6/4,6/3; Travell d. Hadsell, 6/4,6/1; Burchard d. Stephens, 6/4,6/1; Sheafe d. Post, 4/6,6/2,7/5. SEMI-FINAL ROUND—Anderson d. Travell by default; Burchard d. Sheafe, 6/3,9/7. FINAL ROUND—Ross Burchard d. Fred G. Anderson, 6/4,6/4.

## Father and Son Championship

The father and son championship, held at the West Side Tennis Club, Forest Hills, L. I., did not attract as many entries as expected, but some good playing was presented. The big surprise of the competition was the winning of the title by A. H. Chapin, Sr. and Jr., who were not seriously considered. However, they outplayed Fred G. Anderson and his son Fred in the title round in two interesting sets. The summaries:

### DOUBLES.

FIRST ROUND—Dr. Linn Emerson and Son d. George W. French and Son, 2/6,6/3,6/4. SECOND ROUND—F. G. Anderson and Son d. Emerson and Son, 3/6,6/2,6/4; A. H. Chapin and Son d. Gerald Donaldson and Son, 6/1,6/4. SEMI-FINAL ROUND—Anderson and Son d. H. W. Warner and Son, 4/6,6/2,6/1; Chapin and Son d. W. D. Hadsell and Son, 6/1,6/2. FINAL ROUND—A. H. Chapin and A. H. Chapin, Jr., d. Fred G. Anderson and Fred C. Anderson, 6/4,8/6.



FRED B. ALEXANDER,  
New York.

BEALS C. WRIGHT,  
Boston.

Runners-up National Doubles Championship.

## National Doubles Championship

In 1918 the United States National Lawn Tennis Association eliminated the sectional doubles events, which had been held as preliminaries to the national title contest, and substituted an open doubles championship tournament.

Instead, however, of holding the doubles in connection with the singles, as in former years, under the new arrangement the doubles was made a separate feature, to be held at a time and place distinct from the singles.

The Longwood Cricket Club, Boston, was the scene of the first contest, in 1917, but owing to the fact that the tennis events of that year were held as patriotic tournaments, no transfer of titles was possible. Last season, therefore, when title contests were resumed, may be called the first year that actual doubles title competition was held as a separate tournament from the national singles championship.

For 1919 the sectional doubles championships will be resumed, as in former years, and this season will see eleven teams, from as many sections of the country, competing for the doubles title at Longwood, beginning August 12.

Although, naturally, with the nation deep in war projects, the doubles event of last season did not compare favorably with its predecessors of more normal times, nevertheless the class of tennis played was excellent, even though the line of age was distinctly marked, for, with the exception of those in the service whose duties happened to be in the immediate vicinity, the majority of players were either of extreme youth or veterans of the game.

Probably the best known combination was the Alexander-Wright duo, the old internationalists having teamed up for this occasion for the first time since their quest for the Davis Cup at Melbourne, in 1908. Walter Hayes and Ralph Burdick, the Middle West cracks, represented that section, while the famous Kumagae, paired with Harold Taylor, the sixteen-year-old former Metropolitan junior champion, gave an international aspect to the event. Among the others, Nat Niles of Boston and Theodore Roosevelt Pell of New York, Harry C. Johnson and Irving C. Wright, Elliott H. Binzen and J. S. O'Boyle, William T. Tilden, Jr., and Vincent Richards, were among those of national renown who were entered.

The elimination brought the semi-finals contestants in the persons of Niles and Pell, Hayes and Burdick, Tilden and Richards and Alexander and Wright. The former Davis Cup stars had quite a tussle in their match with Kumagae and Taylor, the bulk of the work falling upon the Japanese, who, with a physically more mature partner, might have conquered the veterans.

In the semi-final round the victory of Tilden and young Richards over Niles and Pell was of the sensational order, and it was the younger of the two—Richards—whose dazzling work was largely responsible. In the other bracket, Alexander and Wright, the Eastern pair, eliminated their rivals from Chicago, working with a smoothness and precision that they had not exhibited up to this period.

The final round was a triumph for Tilden and Richards—and individually for Richards—the latter's work against the seasoned pair of veterans never faltering. Never before had a boy so young as Richards earned a national tennis title and, in view of the fact that he was pitted against two such masters of the game as Alexander and Wright, his accomplishment is all the more remarkable.



HAROLD A. THROCKMORTON,  
Elizabeth, N. J.

CONRAD B. DOYLE,  
Washington, D. C.

The Eastern Doubles, which was a Longwood classic since its origin in 1890, was transferred in 1917 to Philadelphia and held in conjunction with the women's national championship. The summary:

## NATIONAL CHAMPIONSHIP DOUBLES.

### FIRST ROUND.

| Winners.                                   | Score.                       | Opponents.                         |
|--|------------------------------|------------------------------------|
| N. W. Niles and T. R. Pell.....            | 6/3, 6/2, 6/2.....           | J. A. Cousens and E. B. Miles      |
| A. N. Reggio and S. L. Rice.....           | 6/1, 6/1, 8/6.....           | A. P. Bryant and W. A. Hopkins     |
| Vincent Richards and W. T. Tilden, Jr..... | 6/3, 7/5, 6/2.....           | H. C. Johnson and Irving C. Wright |
| E. F. Thomas and J. B. Hughes.....         | 6/0, 6/8, 4/6, 6/4, 6/2..... | H. Kersey and E. Hendrickson       |
| E. H. Binzen and J. S. O'Boyle.....        | 2/6, 6/4, 6/4, 6/4.....      | S. L. Beals and W. Rand, Jr.       |
| J. Nowell and A. Kent.....                 | 6/3, 6/3, 6/8, 6/8, 6/2..... | E. Page and R. Baker               |
| Ichiya Kumagae and Harold A. Taylor.....   | 6/3, 6/4, 6/4.....           | G. W. Wightman and C. K. Shaw      |
| Horace Taylor and R. M. Currier.....       | 10/8, 6/1, 5/7, 7/5.....     | W. L. Jennings and W. McKibben     |
| J. S. Myrick and Edwin Sheafe.....         | 6/3, 6/3, 8/6.....           | H. B. Finck and W. L. Wei          |
| F. B. Alexander and B. C. Wright.....      | 6/2, 7/5, 6/2.....           | H. B. Bretz and R. C. Seaver       |
| J. D. E. Jones and R. N. Dana.....         | 6/2, 3/6, 4/6/1, 6/2.....    | F. J. Sulloway and R. Bishop       |
| C. A. Colleston and I. Kent.....           | 7/5, 3/6, 2/6, 6/2, 6/1..... | T. B. Plimpton and C. B. Wilbur    |

### SECOND ROUND.

|                               |                              |                           |
|-------------------------------|------------------------------|---------------------------|
| Niles and Pell.....           | 6/1, 6/3, 6/2.....           | Reggio and Rice           |
| Richards and Tilden.....      | 6/0, 6/1, 6/2.....           | Thomas and Hughes         |
| Binzen and O'Boyle.....       | 6/1, 2/6, 6/8, 8/6, 8/6..... | Nowell and Kent           |
| Kumagae and H. A. Taylor..... | 6/0, 6/3, 7/5.....           | Horace Taylor and Currier |
| Alexander and Wright.....     | 6/4, 6/0, 6/2.....           | Myrick and Sheafe         |
| Jones and Dana.....           | 6/4, 6/3, 6/4.....           | Colleston and Kent        |

### THIRD ROUND.

|                                    |                              |                    |
|------------------------------------|------------------------------|--------------------|
| Niles and Pell.....                | 6/0, 6/3, 6/3.....           | Iler and O'Boyle   |
| Richards and Tilden.....           | 6/3, 6/2, 7/5.....           | Binzen and O'Boyle |
| Alexander and Wright.....          | 6/3, 6/3, 4/6, 4/6, 6/4..... | Kumagae and Taylor |
| W. T. Hayes and R. H. Burdick..... | 10/8, 6/3, 6/2.....          | Jones and Dana     |

### SEMI-FINAL ROUND.

|                           |                         |                   |
|---------------------------|-------------------------|-------------------|
| Richards and Tilden.....  | 7/5, 6/4, 4/6, 6/3..... | Niles and Pell    |
| Alexander and Wright..... | 6/3, 6/2, 6/3.....      | Hayes and Burdick |

### FINAL ROUND.

|   |                          |
|---|--------------------------|
| Vincent Richards and W. T. Tilden, Jr., defeated F. B. Alexander and Beals O. Wright, | 6/3, 6/4, 3/6, 2/6, 6/2. |
|---|--------------------------|



MISS MOLLA BJURSTEDT,  
New York,  
Three Times Winner of the National Championship.



## National Women's Championships

Miss Molla Bjurstedt, by winning the challenge round of the national women's singles championship in 1918—the thirty-first annual competition for the title, there being no title play in 1917—became the permanent possessor of the trophy emblematic of the championship, the Wissahickon Bowl, Miss Bjurstedt's previous victories having been in 1915 and 1916.

The final round of the tournament, which was held June 17 and following days at the Philadelphia Cricket Club, brought together Miss Eleanor Goss and Miss Helene Pollak. The former had previously eliminated Miss Helen Ledoux and Miss Pollak had defeated Miss Clare Cassel. Miss Goss won.

The doubles contest was won by Miss Goss and Miss Marion Zinderstein, who defeated Miss Bjurstedt and Mrs. Johan Rogge of Norway. Mrs. George W. Wightman, who was a former champion when Miss Hazel Hotchkiss, won the mixed doubles with Irving C. Wright.

A new event, the girls' national championship of the United States, was on the programme. The honor of winning the first girls' championship title fell to Miss Catherine Porter of Philadelphia, the runner-up being Miss Dorothy Walker of the same city.

The Eastern Doubles championship, which was transferred from Longwood upon the acquisition of the national doubles event by the New England organization, was contested for the first time under the auspices of the Philadelphia Cricket Club, the play of 1917 under the new patrons not figuring as a title, being a patriotic contest. The winners were Percy S. Osborne and Wallace Rhodes, both Philadelphians. The summaries:

### WOMEN'S SINGLES.

#### FIRST ROUND.

| Winner.                  | Score.   | Opponent.       | Winner.                  | Score.   | Opponent.         |
|--------------------------|----------|-----------------|--------------------------|----------|-------------------|
| Miss R. Thomson.....     | 6/3, 6/4 | Miss M. Dixon   | Mrs. H. F. Kerbaugh..... | 6/2, 6/2 | Mrs. C. Doble     |
| Miss M. Zinderstein..... | 7/5, 6/4 | Miss M. Hillard | Miss K. Porter.....      | 7/5, 6/0 | Mrs. A. D. Smoker |

#### SECOND ROUND.

|                        |          |                     |                           |               |                    |
|------------------------|----------|---------------------|---------------------------|---------------|--------------------|
| Mrs. J. E. Bailey..... | 6/0, 6/3 | Miss Gladys Palne   | Mrs. R. Herold.....       | 7/5, 6/2      | Miss Porter        |
| Miss D. Walker.....    | 6/1, 6/2 | Miss M. T. Rudderow | Miss H. Ledoux.....       | 7/9, 6/4, 6/1 | Miss Anne Townsend |
| Miss H. Pollak.....    | 6/1, 6/1 | Miss M. Moes        | Mrs. J. F. Betz, 3d.....  | 1/6, 6/3, 6/4 | Mrs. H. B. Huff    |
| Miss M. D. Thayer..... | 6/0, 6/2 | Mrs. A. Chisholm    | Miss B. F. Hooker.....    | 6/2, 6/3      | Miss A. Naylor     |
| Mrs. De F. Candee..... | 6/0, 6/1 | Mrs. W. S. Calcott  | Mrs. S. F. Weaver.....    | 6/2, 6/2      | Miss D. Seal       |
| Miss C. Cassel.....    | 6/4, 9/7 | Mrs. J. Rogge       | Mrs. R. B. Payne.....     | 6/3, 6/4      | Miss G. Ostheimer  |
| Miss E. R. Sears.....  | 6/0, 6/1 | Miss Thomson        | Miss E. G. Ostheimer..... | 6/4, 3/6, 6/4 | Miss C. Otis       |
| Miss Zinderstein.....  | 6/0, 6/1 | Mrs. Kerbaugh       | Miss E. Goss.....         | 6/2, 6/4      | Mrs. R. L. Wood    |

#### THIRD ROUND.

|                  |               |                  |                     |                |                |
|------------------|---------------|------------------|---------------------|----------------|----------------|
| Miss Walker..... | 7/5, 6/0      | Miss Bailey      | Miss Ledoux.....    | 7/5, 7/5       | Mrs. Herold    |
| Miss Pollak..... | 7/5, 6/1      | Miss Thayer      | Miss B. Hooker..... | 8/6, 10/8      | Mrs. Betz      |
| Miss Cassel..... | 7/5, 6/3      | Mrs. Candee      | Mrs. Weaver.....    | 4/6, 11/9, 6/2 | Mrs. Payne     |
| Miss Sears.....  | 6/8, 6/2, 6/4 | Miss Zinderstein | Miss Goss.....      | 6/1, 6/0       | Miss Ostheimer |



MISS MARY K. BROWNE,  
Santa Monica, Cal.

MRS. THOMAS C. BUNDY,  
Los Angeles, Cal.

## FOURTH ROUND.

| Winner.          | Score.        | Opponent.   | Winner.          | Score.        | Opponent.      |
|------------------|---------------|-------------|------------------|---------------|----------------|
| Miss Pollak..... | 6/1, 6/0..... | Miss Walker | Miss Ledoux..... | 6/4, 6/1..... | Miss B. Hooker |
| Miss Cassel..... | 6/2, 6/4..... | Miss Sears  | Miss Goss.....   | 6/2, 6/4..... | Mrs. Weaver    |

## SEMI-FINAL ROUND.

|                  |               |             |                |               |             |
|------------------|---------------|-------------|----------------|---------------|-------------|
| Miss Pollak..... | 6/3, 6/0..... | Miss Cassel | Miss Goss..... | 6/3, 6/4..... | Miss Ledoux |
|------------------|---------------|-------------|----------------|---------------|-------------|

## FINAL ROUND.

Miss Eleanor Goss defeated Miss Helene Pollak, 6/2, 7/5.

## CHALLENGE ROUND.

Miss Molla Bjurstedt defeated Miss Eleanor Goss, 6/4, 6/3.

## WOMEN'S DOUBLES.

## FIRST ROUND.

| Winners.                                  | Score.        | Opponents.                           |
|---|---------------|--------------------------------------|
| Mrs. Wood and Mrs. Weaver.....            | 6/0, 6/1..... | Miss Mary Newbold and Miss Naylor    |
| Mrs. Payne and Mrs. Calcott.....          | 6/0, 6/2..... | Miss M. Reid and Miss F. Widener     |
| Miss Bjurstedt and Mrs. J. Rogge.....     | 6/1, 6/2..... | Miss Otis and Miss Ledoux            |
| Miss Seal and Miss Willard.....           | 9/7, 7/5..... | Miss Thayer and Miss Newbold         |
| Miss Zinderstein and Miss Goss.....       | 6/4, 6/0..... | Miss Porter and Miss Gertrude Conway |
| Miss Dixon and Mrs. C. R. Wainwright..... | 6/3, 6/0..... | Miss V. Carpenter and Miss M. Geary  |
| Miss Sears and Mrs. Wightman.....         | 6/1, 8/6..... | Miss Cassel and Miss Pollak          |

## SECOND ROUND.

|   |                    |  |
|---|--------------------|--|
| Miss Hollis and Miss Taylor.....          | 6/8, 6/3, 6/1..... | Miss M. Heaton and Miss A. Hooker      |
| Miss Walker and Miss Dixon.....           | 8/6, 6/2.....      | Mrs. Bailey and Mrs. Betz              |
| Mrs. Wood and Mrs. Weaver.....            | 6/0, 6/2.....      | Mrs. Payne and Mrs. Calcott            |
| Miss Bjurstedt and Mrs. Rogge.....        | 6/4, 6/2.....      | Miss B. Hooker and Miss H. Hooker      |
| Miss Zinderstein and Miss Goss.....       | 6/4, 6/0.....      | Miss Seal and Miss Willard             |
| Miss Sears and Mrs. Wightman.....         | 6/1, 6/0.....      | Miss Dixon and Mrs. Wainwright         |
| Mrs. Kerbaugh and Mrs. Herold.....        | 5/7, 6/4, 7/5..... | Miss Townsend and Miss Thomson         |
| Mrs. Candee and Miss Florence Ballin..... | 6/2, 6/3.....      | Miss E. Strubing and Miss M. Sharpless |

## THIRD ROUND.

|                                     |                    |                               |
|-------------------------------------|--------------------|-------------------------------|
| Miss Walker and Miss Dixon.....     | 6/8, 6/3, 6/1..... | Miss Hollis and Miss Taylor   |
| Miss Bjurstedt and Mrs. Rogge.....  | 6/0, 6/2.....      | Mrs. Wood and Mrs. Weaver     |
| Miss Zinderstein and Miss Goss..... | 4/6, 6/2, 6/3..... | Miss Sears and Mrs. Wightman  |
| Mrs. Candee and Miss Ballin.....    | 5/7, 7/5, 6/1..... | Mrs. Kerbaugh and Mrs. Herold |

## SEMI-FINAL ROUND.

|                                     |                    |                             |
|-------------------------------------|--------------------|-----------------------------|
| Miss Bjurstedt and Mrs. Rogge.....  | 6/1, 6/3.....      | Miss Walker and Miss Dixon  |
| Miss Zinderstein and Miss Goss..... | 5/7, 7/5, 6/1..... | Mrs. Candee and Miss Ballin |

## FINAL ROUND.

Miss Marion Zinderstein and Miss Eleanor Goss defeated Miss Molla Bjurstedt and Mrs. J. Rogge, 7/5, 8/6.

## MIXED DOUBLES.

## FIRST ROUND.

|   |                     |                                 |
|---|---------------------|---------------------------------|
| Miss Thomson and W. L. Thomson....      | 8/10, 6/3, 6/3..... | Miss B. Hooker and E. H. Hooker |
| Mrs. Weaver and Wheelan.....            | 6/1, 6/2.....       | Mrs. Kerbaugh and A. J. Baltz   |
| Mrs. Wightman and I. C. Wright.....     | 6/0, 6/1.....       | Miss Naylor and H. B. Endicott  |
| Miss H. Hooker and A. E. Van Pelt.....  | 3/6, 6/3, 6/2.....  | Miss Seal and A. P. Hawes       |
| Miss Bjurstedt and F. B. Alexander..... | 6/1, 6/1.....       | Miss Sears and Percy Osborne    |

## SECOND ROUND

|  |                    |                                    |
|--|--------------------|------------------------------------|
| Miss Zinderstein and W. H. Abbott..... | 6/0, 6/1.....      | Mrs. J. A. Brown and H. D. Pratt   |
| Miss Thomson and Thomson.....          | 6/2, 1/6, 7/5..... | Miss Carpenter and J. R. Carpenter |
| Mrs. Wightman and Wright.....          | 6/1, 6/1.....      | Mrs. Weaver and Wheelan            |
| Miss Bjurstedt and Alexander.....      | 6/1, 6/1.....      | Miss Hooker and Van Pelt           |
| Miss Cassel and Elliott Binzen.....    | 6/2, 6/1.....      | Miss Zinderstein and Abbott        |



1. Miss Marie Wagner, New York: New York State and Eastern New York Champion. 2. Mrs. George W. Wightman, Boston: National Mixed Doubles Champion.

## SEMI-FINAL ROUND.

| Winners.                          | Score.        | Opponents.               |
|-----------------------------------|---------------|--------------------------|
| Mrs. Wightman and Wright.....     | 6/2, 6/1..... | Miss Thomson and Thomson |
| Miss Bjurstedt and Alexander..... | 6/1, 6/4..... | Miss Cassel and Binzen   |

## FINAL ROUND.

Mrs. George W. Wightman and Irving C. Wright defeated Miss Molla Bjurstedt and F. B. Alexander, 6/2, 6 4.

## EASTERN DOUBLES.

FIRST ROUND—Irving C. Wright and A. H. Abbott d. Harold A. Taylor and Horace Taylor, 6/1,6/1. SECOND ROUND—Joseph R. Carpenter, Jr., and Charles B. Jennings d. E. T. Hutchins and H. W. Hanna, 6/3,6/2; Wright and Abbott d. H. G. Jones and Gilbert Sommers, 6/1,6/1; Paul W. Gibbons and George R. Powell d. A. J. Baltz and H. C. Simmen, 6/0,6/3. SEMI-FINAL ROUND—Wright and Abbott d. Carpenter and Jennings, 6/4,9/7; Percy Osborne and Wallace Rhoades d. Gibbons and Powell, 6/1,6/2. FINAL ROUND—Percy Osborne and Wallace Rhoades d. Irving C. Wright and W. H. Abbott, 2/6,6/2,6/4,0/6,6/1.

## GIRLS' JUNIOR SINGLES.

FIRST ROUND—Miss Barbara F. Hooker d. Miss Mary Newbold, 7/5,6/1; Miss Elizabeth Strubing d. Miss Adelaide F. Hooker, 5/7,6/4,7/5; Miss Katharine Porter d. Miss Margaretta A. Sharpless, 6/2,7/5. SEMI-FINAL ROUND—Miss Dorothy Walker d. Miss Mary Heaton, 6/3,6/2; Miss Porter d. Miss Louise Dixon, 6/4,7/5. FINAL ROUND—Miss Katharine Porter d. Miss Dorothy Walker, 6/3,8/6.

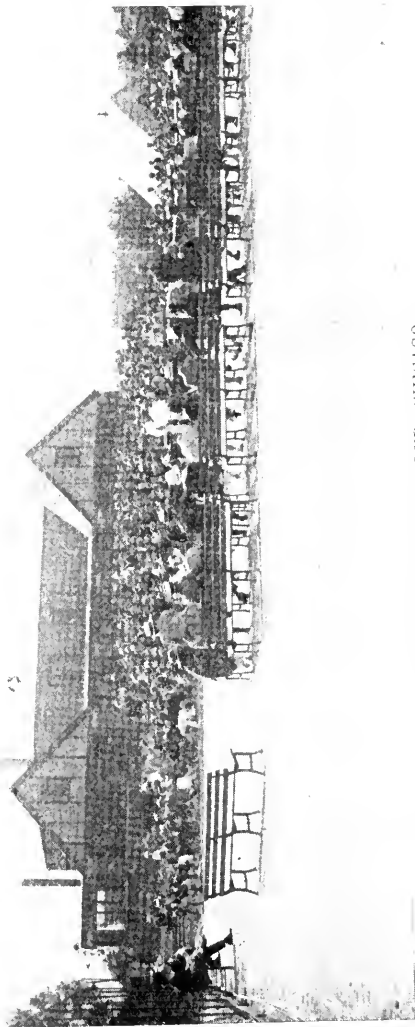

SOUTH SIDE TENNIS CLUB, CHICAGO.  
Where the United States Clay Court Championships will be held in 1919.

## Clay Court Championships

The eighth clay court championships, held on the twenty-four clay courts of the South Side Tennis Club of Chicago, June 29 to July 6, 1918, brought together stars from the East, the West, the North and the South, and provided at times tennis so exciting and of such high grade that the tournament will rank as one of the great successes in the annals of Chicago tennis.

This tournament had been abandoned the previous year in favor of a patriotic event, held in Cincinnati. With no titles to play for, only two out-of-town men, Garland and Hardy, had competed. But the resumption of championship titles in 1918 reacted favorably upon the entry list. Applications poured in from all sections of the country, until the tournament committee was forced to limit the entries to 128.

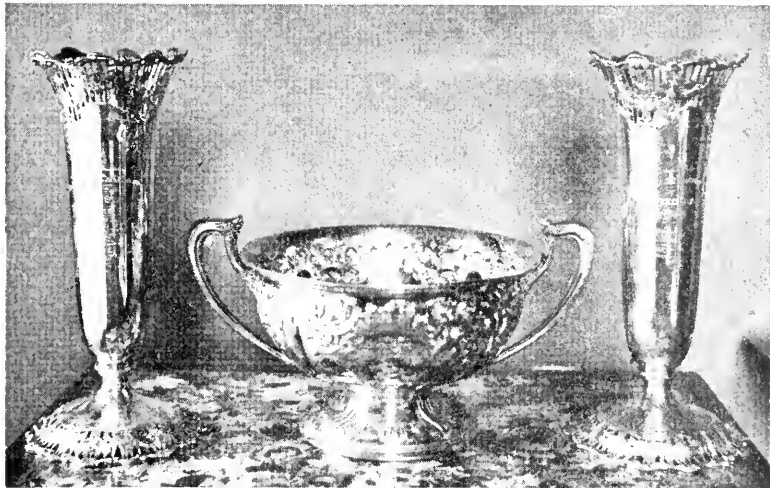

UNITED STATES CLAY COURT CHAMPIONSHIP TROPHIES.

Of the visitors, Tilden, Garland, Adoue and Hendrick were considered the chief contenders for the singles title, while Hayes, Hardy and Burdick each had his local supporters. The first surprise came with the defeat of Adoue by Day, a veteran Chicago player, who was more accustomed to the Chicago winds than the champion of the Southwest. Hendrick failed to gauge correctly the peculiar cut stroke of Oelsner and went down in a close, well fought match. But the real surprise of the tournament was Oelsner's win over Burdick, who played nervously throughout the match. Oelsner, sensing his advantage, mixed his chops and drives with nice discrimination and thoroughly earned his win.

Both Day and Oelsner, however, met their Waterloo in Charles Garland, whose unassuming style lulled them into a false sense of security. Only those who have struggled against Garland's smooth, machine-like game can appreciate its deadly accuracy.

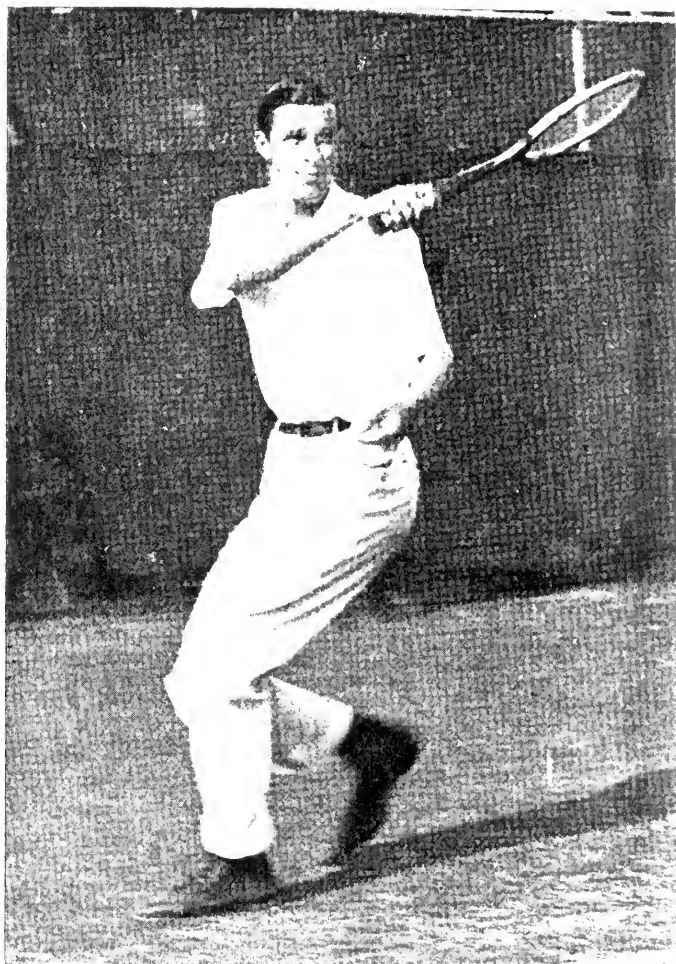

WILLIAM T. TILDEN, JR.,  
Philadelphia.

United States Clay Court Champion; National Doubles Champion;  
Runner-up National Singles.



Hayes in the meantime had defeated Hardy, who lost whatever chance of success he may have had by a bad fall. Having previously outsteaded Josties of St. Louis, Hayes was now ready for Tilden, who also had reached the semi-finals without extending himself.

The Tilden-Hayes match proved the feature of the tournament. Tilden had so far shown up as the best Eastern player of the year, while Hayes had been Chicago's leading player for two seasons. Hayes, who under all circumstances can be depended upon to give a good account of himself, played true to form; but his utmost efforts and his fine passing shots, while they gained him many points, were not equal to the all-around game of Tilden. If Hayes is a steady baseliner, so is Tilden. When the latter elected to exchange shots in a base-line duel, he held his own with Hayes. Yet one always felt that he was biding his time for a short return, for at every such slip on the part of his opponent, Tilden would sweep toward the ball in a rush that would carry him close to the net, where his enormous reach and deadly volleying usually won him the point. Following this method with success for two sets, he palpably rested during the third, which Hayes won at 6/1. The crowd was now buzzing like a hive. Many believed Tilden had shot his bolt.

As the fourth set progressed and Hayes assumed the lead, knowing heads were nodded. At 5/3, Hayes was three times within a point of the set. Twice Hayes missed his favorite shot, each time from exactly the same position, the ball striking the tape only to drop back into his court. A gasp went up from the crowd, for had either ball trickled over the net, the fourth set, and in all probability the match, would have been Hayes'. Tilden, encouraged by this bit of luck, displayed a burst of speed that carried him to victory.

The final between Tilden and Garland proved less exhilarating than the semi-finals. Garland's machine-like game has little of the spectacular about it, and the fireworks came chiefly from Tilden. He employed much the same tactics as in his match with Hayes, demonstrating his mastery of every known stroke. When he again dropped the third set, Garland's adherents had hope for the first time; but the fourth saw Tilden in his most irresistible mood, and he allowed his opponent but two games.

The doubles failed to furnish any particular excitement up to the final round, where, as predicted, Garland and Hardy met Hayes and Burdick. Tilden and Waidner might have proved a stumbling block to either team had Tilden not shown an obvious intent of saving himself for singles. Adoue and Wright, the Southwestern champions, and Hendrick and Bowen of Buffalo were possibilities, but the former were eliminated by O'Connor and Benson of Jackson Park, while the latter lost to Cochran and Campbell, a new combination that worked so well that they afterward defeated Miller and Forstall, finalists in the Chicago city championship. The match between the Hayes-Burdick combination and the Garland-Hardy, went to five sets. To Garland, who had just played his singles with Tilden, particular credit is due. His play was as sound as usual, and backed by Hardy's heady game, they won after a hard struggle.

Hardy was not the only home player to win a national title, for Miss Carrie B. Neely justified her reputation as the best local player by winning the women's singles. Mrs. Adelaide Yager of Los Angeles smoothed the way for her by removing both Mrs. McNeill and Miss Waldo, the latter having beaten Miss Neely in the city championship. In the final round Mrs. Yager fell before the steadier play and superior volleying of Miss Neely. Another Chicago winner was Mrs. Ralph Field, who, with Miss Bobbie Esch of Cleveland, fought



SAMUEL HARDY AND CHARLES S. GARLAND,  
United States Clay Court Doubles Champions.

a hard battle against Miss Neely and Mrs. Yager in the final of the women's doubles. Miss Esch gamely undertook the long journey from her native city alone, and besides winning the doubles gave a good account of herself in the singles, pushing Miss Neely to 7/5 in the first set. The summaries:

## MEN'S SINGLES

## FIRST ROUND.

| Winner.                     | Score.         | Opponent.         | Winner.               | Score.         | Opponent.        |
|-----------------------------|----------------|-------------------|-----------------------|----------------|------------------|
| J. R. McKnight.....         | 6/2, 6/1       | H. L. Beyer       | George O'Connell..... | 1/6, 7/5, 6/2  | J. A. Farley     |
| W. T. Hayes.....            | 6/0, 6/1       | L. E. Murphy      | C. S. Garland.....    | 6/0, 6/2       | A. S. Merigold   |
| Davison Obeare.....         | 6/0, 6/2       | Joseph M. Lewin   | David Robertson.....  | 3/6, 6/2, 6/0  | N. L. Ritchie    |
| E. E. Wiley.....            | 6/3, 6/4       | John H. Riddell   | Alfred Bennett.....   | 2/6, 6/4, 7/5  | L. T. Rountree   |
| L. C. Nutter.....           | 6/2, 7/5       | J. H. Evans       | J. F. Day.....        | 6/3, 6/3       | Frank Weadley    |
| W. S. Miller.....           | 6/0, 6/0       | Dale J. Hodges    | A. W. Degener.....    | 6/1, 6/2       | A. H. Franheim   |
| T. H. Cochran.....          | 6/3, 6/1       | A. B. Caleen      | B. J. Luidens.....    | 6/1, 6/1       | C. L. Frederick  |
| Sam Hardy.....              | 6/1, 6/1       | Leo J. Lunn       | J. B. Adoue.....      | 6/1, 6/1       | H. D. Warner     |
| C. O. Carlstrom.....        | 6/2, 6/3       | J. O. Roberts     | I. W. Hadsell.....    | 6/1, 6/3       | J. B. Holmes     |
| D. W. Westervelt.....       | 6/3, 6/2       | H. A. Blossat     | A. L. Green, Jr.....  | 6/2, 9/11, 6/0 | L. R. Hayes      |
| A. C. Snow.....             | 6/3, 6/1       | W. H. Sterling    | A. Frankenstein.....  | 6/4, 2/6, 6/4  | C. V. Zeller     |
| P. V. Bowen.....            | 6/2, 6/1       | H. E. Cragin      | H. P. Howland.....    | 6/0, 7/5       | G. A. Rathbun    |
| V. J. Huntington.....       | 10/8, 2/6, 7/5 | D. E. Kissam      | Taylor Ward.....      | 6/3, 7/9, 6/0  | E. N. McBride    |
| A. Wallerstein.....         | 6/0, 6/3       | J. E. Mills       | E. W. Wilson.....     | 6/1, 6/4       | F. H. Gill       |
| J. P. Benson.....           | 6/1, 6/4       | R. Curran, Jr.    | R. H. Burdick.....    | 6/3, 6/3       | A. L. Green, Sr. |
| W. S. Salt.....             | 6/2, 2/6, 6/1  | Norman R. Engel   | Wilbur Jackson.....   | 10/8, 8/6      | E. B. Lucius     |
| Dr. T. R. Hollingshead..... | 6/4, 2/6, 6/0  | F. F. Fogg        | R. F. Woods.....      | 8/6, 7/9, 6/1  | A. L. Vernon     |
| W. T. Tilden, Jr.....       | 6/0, 6/2       | Reader J. Hubbell | Paul Frank.....       | 6/2, 6/3       | P. N. Schmit     |
| R. H. Browne.....           | 6/4, 6/3       | Harry S. Knox     | T. Hendrick.....      | 6/0, 6/3       | R. F. Farnham    |
| Walter Kramer.....          | 6/3, 6/2       | J. W. Dunbar      | E. H. Hess.....       | 6/4, 10/8      | F. A. Cohen      |
| C. E. Wilson.....           | 6/3, 3/6, 6/4  | S. D. Fogelson    | Edward Oelsner.....   | 6/0, 6/3       | George Pasmore   |
| L. H. Waidner.....          | 6/1, 6/4       | L. R. Campbell    | R. R. Harrison.....   | 6/1, 6/1       | Thomas Davies    |
| Roy Turvey.....             | 6/4, 6/4       | A. G. Wicker      |                       |                |                  |

## SECOND ROUND.

|                      |                  |                     |                    |               |              |
|----------------------|------------------|---------------------|--------------------|---------------|--------------|
| R. G. England.....   | 19/8, 0/6, 15/13 | McKnight            | Carlstrom.....     | 6/3, 6/3      | C. J. Weber  |
| Hayes.....           | 6/1, 6/1         | B. K. Engel         | E. H. Fabrice..... | 3/6, 6/4, 6/2 | Westervelt   |
| Fred L. Josties..... | 6/2, 6/3         | Clarenee Rose       | Snow.....          | 4/6, 8/6, 7/5 | Bowen        |
| Obeare.....          | 6/2, 6/2         | O. Chatfield Taylor | Wallerstein.....   | 9/7, 6/0      | Huntington   |
| E. B. Peirsel.....   | 6/0, 6/3         | E. E. Wiley         | Benson.....        | 6/0, 6/4      | Salt         |
| Miller.....          | 6/3, 6/2         | Nutter              | Milton Agay.....   | 7/5, 6/3      | Hollingshead |
| Hardy.....           | 6/3, 6/1         | Cochran             | Tilden.....        | 6/0, 6/1      | Browne       |

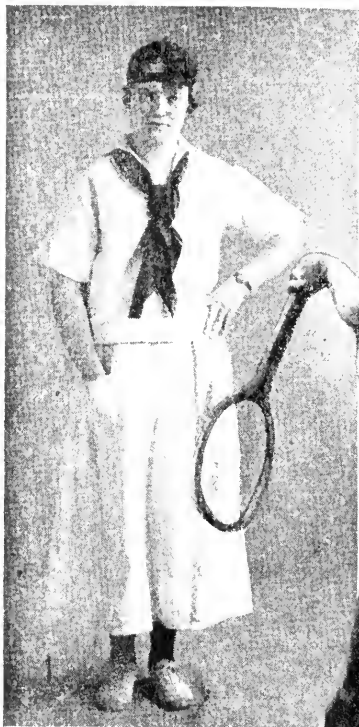

MRS. RALPH FIELD,  
Chicago.  
United States Clay Court Doubles Champions.

MISS "BOBBIE" ESCH,  
Cleveland.

MEN'S SINGLES, SECOND ROUND—Continued.

| Winner.              | Score.        | Opponent.          | Winner.             | Score.         | Opponent.    |
|----------------------|---------------|--------------------|---------------------|----------------|--------------|
| Kramer.....          | 6/3, 5/7, 6/2 | George W. Campbell | Harold Forster..... | 6/0, 6/3       | Hadsell      |
| F. T. O'Brien.....   | 6/3, 7/5      | Wilson             | Green .....         | 6/2, 8/6       | Frankenstein |
| Don F. Wiley.....    | default       | Roland Constant    | Howland.....        | 6/4, 6/4       | R. Bentley   |
| Waidner.....         | 6/2, 6/3      | B. Nath            | Ward .....          | 8/6, 5/7, 11/9 | Wilson       |
| R. A. Y. Arnold..... | default       | Turvey             | Burdick .....       | 6/0, 6/2       | Jackson      |
| Garland .....        | 6/3, 6/0      | O'Connell          | Woods .....         | 6/1, 8/6       | Frank        |
| Robertson .....      | 6/3, 6/1      | Bennett            | Hendrick .....      | 6/1, 6/0       | Hess         |
| Day .....            | 6/0, 6/0      | Degener            | Oelsner.....        | 6/1, 6/2       | Pierce Ward  |
| Adoue .....          | 6/1, 6/0      | Luidens            | Harrison .....      | default        | Kerr         |

THIRD ROUND.

|               |           |             |                |               |           |
|---------------|-----------|-------------|----------------|---------------|-----------|
| Hayes .....   | 6/1, 6/2  | England     | Waidner .....  | 6/1, 7/5      | Wiley     |
| Josties ..... | 11/9, 6/0 | Obear       | Garland .....  | 6/0, 6/4      | Arnold    |
| Miller .....  | 6/0, 6/4  | Peirsel     | Day .....      | 6/0, 6/2      | Robertson |
| Hardy .....   | 6/3, 6/3  | Carlstrom   | Adoue .....    | 7/5, 4/6, 6/2 | Forster   |
| Snow .....    | 6/0, 6/0  | Fabrice     | Green .....    | 6/0, 6/4      | Howland   |
| Benson .....  | 6/2, 6/0  | Wallerstein | Burdick .....  | 6/1, 6/0      | Ward      |
| Tilden .....  | 6/2, 6/2  | Agay        | Hendrick ..... | 6/2, 6/0      | Woods     |
| Kramer .....  | default   | O'Brien     | Oelsner .....  | 6/4, 6/0      | Harrison  |

FOURTH ROUND.

|              |               |         |               |               |          |
|--------------|---------------|---------|---------------|---------------|----------|
| Hayes .....  | 6/0, 6/1      | Josties | Garland ..... | 6/2, 6/1      | Waidner  |
| Hardy .....  | 6/3, 6/0      | Miller  | Day .....     | 6/2, 1/6, 6/2 | Adoue    |
| Snow .....   | 8/6, 5/7, 6/3 | Benson  | Burdick ..... | 6/2, 6/2      | Green    |
| Tilden ..... | 6/3, 6/3      | Kramer  | Oelsner ..... | 6/3, 7/9, 6/2 | Hendrick |

FIFTH ROUND.

|              |          |       |               |               |         |
|--------------|----------|-------|---------------|---------------|---------|
| Hayes .....  | 6/0, 6/4 | Hardy | Garland ..... | 6/2, 6/1      | Day     |
| Tilden ..... | 6/3, 6/1 | Snow  | Oelsner ..... | 6/3, 2/6, 7/5 | Burdick |

SEMI-FINAL ROUND.

W. T. Tilden, Jr., d. W. T. Hayes, 7/5, 6/2, 1/6, 7/5; C. S. Garland d. Edward Oelsner, 6/0, 6/2, 6/3.

FINAL ROUND.

W. T. Tilden, Jr., d. Charles S. Garland, 6/4, 6/4, 3/6, 6/2.

MEN'S DOUBLES

FIRST ROUND.

| Winners.                                  | Score.        | Opponents.                         |
|---|---------------|------------------------------------|
| W. T. Hayes and R. H. Burdick.....        | 6/1, 6/2      | H. D. Warner and F. Wilber         |
| R. H. Browne and E. Hess.....             | 6/4, 7/5      | J. Riddel and L. T. Rountree       |
| A. L. Green, Jr., and A. C. Snow.....     | 6/0, 8/6      | Wilbur Jackson and L. C. Nutter    |
| B. J. Luidens and A. G. Wicker.....       | 3/6, 6/0, 6/1 | F. Cohen and F. Lasley             |
| W. H. Sterling and R. A. Arnold.....      | 6/4, 6/2      | R. Constant and F. C. Dana         |
| J. A. Farley and D. W. Westervelt.....    | 7/5, 6/4      | H. S. Knox and R. L. Van Arsdale   |
| W. T. Tilden, Jr., and L. H. Waidner..... | 6/2, 6/4      | A. Frankenstein and S. R. Harrison |
| F. T. O'Brien and B. K. Engel.....        | 6/1, 6/1      | H. E. Cragin and R. Bentley        |
| E. Oelsner and Don Wiley.....             | 6/0, 6/0      | T. Davies and W. J. Davis          |

SECOND ROUND.

|  |                |                                 |
|--|----------------|---------------------------------|
| A. L. Green, Sr., and W. S. Hubbard..... | 8/6, 1/6, 11/9 | I. Hadsell and B. T. Ward       |
| J. J. Forstall and W. S. Miller.....     | 6/4, 6/3       | S. P. Cook and L. G. Sharp      |
| T. H. Cochran and L. R. Campbell.....    | 6/3, 10/8      | E. B. Lucius and C. V. Zeller   |
| J. B. Adoue and G. S. Wright.....        | 6/3, 6/2       | H. A. Bissat and L. R. Hayes    |
| D. Robertson and W. S. Salt.....         | 6/1, 7/5       | J. M. Lewin and Leo J. Lunn     |
| Hayes and Burdick.....                   | 6/1, 7/5       | A. S. Merigold and E. W. Wilson |
| D. Obear and George Pasmore.....         | 2/6, 6/4, 6/3  | Browne and Hess                 |



1, Harry C. Johnson, Massachusetts State Champion in Singles and Doubles. 2, Irving C. Wright, National Mixed Doubles Champion; Massachusetts State Doubles Champion. 3, Dr. William Rosenbaum, New York, Middle States Doubles Champion. 4, Dr. Sumner Hardy, President California Tennis Association. 5, Carl R. Gardner, Pacific Coast expert.

## MEN'S DOUBLES, SECOND ROUND—Continued.

| Winners.                                  | Score.             | Opponents.                     |
|---|--------------------|--------------------------------|
| A. L. Green, Jr., and A. C. Snow.....     | default.....       | Luidens and Wicker             |
| T. R. Hollingshead and F. O. Josties..... | 6/1, 6/2.....      | Sterling and Arnold            |
| Tilden and Waidner.....                   | 6/3, 4/6, 6/2..... | Farley and Westervelt          |
| Oelsner and Wiley.....                    | 6/4, 7/5.....      | O'Brien and Engel              |
| E. H. Fabrice and E. B. Peirsel.....      | 6/2, 6/2.....      | J. H. Evans and C. J. Weber    |
| A. Bennett and R. Curran, Jr.....         | default.....       | D. J. Hodges and G. A. Rathbun |
| S. Hardy and C. S. Garland.....           | 6/0, 6/3.....      | J. F. Day and R. F. Woods      |
| J. P. Benson and G. J. O'Connell.....     | 4/6, 6/1, 6/3..... | C. O. Carlstrom and F. Wendley |
| P. V. Bowen and T. Hendrick.....          | 6/0, 6/1.....      | M. Agay and H. Forster         |

## THIRD ROUND.

|                           |                    |                          |
|---------------------------|--------------------|--------------------------|
| Forstall and Miller.....  | 6/4, 1/6, 6/1..... | Green and Hubbard        |
| Cochran and Campbell..... | 3/6, 7/5, 7/5..... | Adoue and Wright         |
| Hayes and Burdick.....    | 6/2, 6/2.....      | Robertson and Salt       |
| Green and Snow.....       | 6/2, 3/6, 7/5..... | Obear and Pasmore        |
| Tilden and Waidner.....   | 6/3, 6/2.....      | Hollingshead and Josties |
| Oelsner and Wiley.....    | 6/3, 4/6, 6/0..... | Fabrice and Peirsel      |
| Hardy and Garland.....    | default.....       | Bennett and Curran       |
| Benson and O'Connell..... | 9/7, 7/5.....      | Bowen and Hendrick       |

## FOURTH ROUND.

|                           |                    |                      |
|---------------------------|--------------------|----------------------|
| Cochran and Campbell..... | 9/7, 4/6, 8/6..... | Forstall and Miller  |
| Hayes and Burdick.....    | 6/3, 6/4.....      | Green and Snow       |
| Tilden and Waidner.....   | 10/8, 6/4.....     | Oelsner and Wiley    |
| Hardy and Garland.....    | 6/1, 6/1.....      | Benson and O'Connell |

## SEMI-FINAL ROUND.

|                        |                    |                      |
|------------------------|--------------------|----------------------|
| Hayes and Burdick..... | 6/1, 6/1, 8/6..... | Cochran and Campbell |
| Hardy and Garland..... | 6/0, 6/1, 6/3..... | Tilden and Waidner   |

## FINAL ROUND.

Samuel Hardy and Charles S. Garland d. Walter T. Hayes and Ralph H. Burdick,  
6/4, 1/6, 6/2, 7/9, 6/2.

## WOMEN'S SINGLES

## FIRST ROUND.

| Winner.               | Score.   | Opponent.       | Winner.             | Score.   | Opponent.      |
|-----------------------|----------|-----------------|---------------------|----------|----------------|
| Miss C. B. Neely..... |          | Miss Timms      | Mrs. E. Wiegel..... |          | Miss V. McCary |
|                       | 6/1, 6/0 |                 |                     | 6/0, 6/0 |                |
| Mrs. A. Yager.....    |          | Mrs. M. McNeill | Miss K. Waldo.....  |          | Mrs. R. Field  |
|                       | 6/3, 6/3 |                 |                     | 6/2, 6/3 |                |

## SECOND ROUND.

|                   |            |                  |                 |          |                  |
|-------------------|------------|------------------|-----------------|----------|------------------|
| Miss Neely.....   | 6/2, 6/3   | Miss M. Leighton | Mrs. Yager..... | 6/2, 6/0 | Mrs. Wiegel      |
| Miss B. Esch..... | 9/7, 14/12 | Miss A. Falkner  | Miss Waldo..... | 6/0, 6/0 | Mrs. W. T. Hayes |

## SEMI-FINAL ROUND.

Miss Carrie B. Neely d. Miss Bobbie Esch 7/5, 6/1; Mrs. Adelaide Yager d. Miss  
Katherine Waldo, 6/2, 6/2.

## FINAL ROUND.

Miss Carrie B. Neely d. Mrs. Adelaide Yager, 6/4, 6/2.

## WOMEN'S DOUBLES

## FIRST ROUND.

| Winner.                          | Score.        | Opponent.                      |
|----------------------------------|---------------|--------------------------------|
| Mrs. McNeill and Miss Waldo..... | 6/4, 6/4..... | Miss Falkner and Miss Leighton |

## SEMI-FINAL ROUND.

|                                |                    |                             |
|--------------------------------|--------------------|-----------------------------|
| Miss Neely and Mrs. Yager..... | 6/3, 6/1.....      | Mrs. Wiegel and Miss Timms  |
| Miss Esch and Mrs. Field.....  | 2/6, 8/6, 6/3..... | Mrs. McNeill and Miss Waldo |

## FINAL ROUND.

Miss Bobbie Esch and Mrs. Ralph Field d. Miss Carrie B. Neely and Mrs. Adelaide  
Yager, 6/4, 4/6, 6/4.



VINCENT RICHARDS,  
New York.

National Doubles Champion; National Indoor Champion; National Boys'  
Champion.

Photo © by Corte-Scope Co., Cleveland, O.



# National Indoor Championships, 1919

BY S. R. McALLISTER, NEW YORK.

The twentieth annual tournament for the national indoor championships for men, held at the Seventh Regiment Armory, New York, beginning March 29, resulted in the most sensational match and result in the history of the competition. The singles title narrowed down to a contest between William T. Tilden, Jr., and Vincent Richards, and with a lead of two sets to one, defeat for Tilden did not appear probable. In the fourth and fifth sets, however, he showed a great falling off in his playing and Richards emerged a winner. The doubles was disappointing, but the better pair won, Tilden and Richards winning the honors from Fred B. Alexander and William Rosenbaum after five sets.

S. Howard Voshell, who defeated Alexander for the title last year, had easy sailing until he met Tilden, the latter winning after Voshell had much the better of nearly two sets. Richards' hardest match on his way to the final was with Fred Anderson in the fourth round. In the first and part of the second set Richards was completely outplayed, but he never lost confidence. From the time of winning the second set he gave a fine exhibition of well judged play and the result never seemed to be in doubt. It was not Voshell alone that put Tilden to the supreme test, for in the fifth round Frank Anderson gave him quite a heated argument, and the dash and speed of the latter quite surprised Tilden, who finally won, 7/9,14/12,6/3.

The matches in the doubles that stood out did so chiefly by their length. Cragin and Campbell won the second set in the first round from Hendrickson and Emerson only at 19/17. Shafer and Smith won from Campbell and Cragin after weakening in the second set. In the third round, Alexander and Rosenbaum and Tilden and Richards, who were in opposite halves, both won in straight sets. The other pairs to go into the semi-finals were the Anderson brothers and Allen Behr and J. H. Steinkampf. The summaries:

## MEN'S SINGLES.

FIRST ROUND—Frank T. Anderson d. G. H. Coster, 6/0,6/2; H. S. Parker d. Dr. Willard Travell, 6/4,7/5; G. S. Groesbeck d. J. L. Anderson, 4/6,6/3,6/3; Leonard Beekman d. C. F. Clarkson, 6/4,6/1; Jerry Lange d. F. Hardcastle, Jr., 6/4,7/5; S. H. Voshell d. J. D. Keyes, 6/3,6/2; E. H. Hendrickson d. Harry Sachs, 6/4,7/5; Gerald B. Emerson d. William Rosenbaum, 8/10,6/3,6/4; G. C. Shafer d. Alexander Iler, 6/2,6/2; Peter Ball d. W. H. Pritchard, 6/2,6/2; P. L. Kynaston d. C. B. Stewart, 6/0,6/4; M. A. Macksoud d. Lient. J. Adelus, 6/0,6/3; I. F. Hartman d. F. W. Whithall, 6/2,6/1; C. J. Post d. S. W. Merrihew, 6/0,6/1; H. B. O'Boyle d. S. E. Palmer, 6/2,6/3; Fred C. Anderson d. S. R. McAllister, 6/8,6/3,6/3; T. E. LeGros d. H. G. Snow, 6/3,6/1. SECOND ROUND—L. B. Dailey, Jr., d. Charles Hall, 6/1,6/0; Frank Anderson d. Parker, 6/1,11/13,6/2; Groesbeck d. W. H. Ruxton, 6/3,6/2; W. T. Tilden, Jr., d. Augustin Healy, 6/2,6/1; Beekman d. Lange, 8/6,6/4; Voshell d. C. M. Amerman, 6/2,6/0; Emerson d. Hendrickson, 6/3,6/4; Shafer d. A. Bassford, 3d, 6/4,6/4; Ball d. Frank Loughman, 6/4,6/4; W. J. Toussaint d. Kynaston, 7/5,6/4; Hartman d. Macksoud, 6/2,6/1; Post d. John McLoughlin, 6/1,6/3; Fred Anderson d. O'Boyle, 9/7,7/5; Vincent Richards d. Legros, 6/3,6/3; G. O. Wagner d. Harry Brunie, 6/3,6/2. THIRD ROUND—Dailey d. R. J. Sommer, 4/6,6/3,6/2; Frank Anderson d. Groesbeck, 6/3,12/10; Tilden d. Beekman, 6/2,6/3; Voshell d. Emerson, 16/14,6/0; Ball d. Shafer, 6/4,6/3; Toussaint d. Hartman, 6/2,6/8,6/2; Fred Anderson d. Post, 6/3,6/4; Richards d. Wagner, 6/4,6/3. FOURTH ROUND—Frank Anderson d. Dailey, 6/0,6/3; Tilden d. Voshell, 4/6,8/6,13/11; Ball d. Toussaint, 2/6,6/2,6/3; Richards d. Fred Anderson, 1/6,6/4,6/3. SEMI-FINAL ROUND—Tilden d. Frank Anderson, 7/9,14/12,6/3; Richards d. Ball, 6/3,6/2. FINAL ROUND—Vincent Richards d. William T. Tilden, Jr., 3/6,6/3,6/8,6/1,6/4.

## MEN'S DOUBLES.

FIRST ROUND—A. S. Cragin and W. A. Campbell d. Emerson and Hendrickson, 6/3,19/17; Shafer and King Smith d. Healy and Gerald Donaldson, Jr., 6/1,6/2; Voshell and Craig Biddle d. Travell and Groesbeck, 6/3,6/4. SECOND ROUND—Toussaint and F. M. Letson



1. Miss Edith B. Handy, Staten Island, N. Y. 2. Mrs. Edward Raymond, Hartsdale, N. Y. 3. Miss Marion Zinderstein, West Newton, Mass. 4. Miss Helen Rice, Metropolitan Junior Champion.

d. Ruxton and Hardcastle, 6/1,6/2; F. C. Anderson and F. T. Anderson d. J. L. Anderson and McAllister, 4/6,6/1,6/3; Tilden and Richards d. Pritchard and Lange, 6/2,6/2; Voshell and Biddle d. Symonds and Hartman by default; F. B. Alexander and Rosenbaum d. Loughman and McLaughlin, 6/4,6/2; Shafer and Smith d. Cragin and Campbell, 6/4,1/6, 6/4; Post and Wagner d. Whital and L. Coffin, 4/6,6/0,6/1; Allen Behr and J. H. Steinkampf d. Ball and Blodgett, 6/2,6/8,6/4. THIRD ROUND—Anderson and Anderson d. Toussaint and Letson, 6/2,6/4; Alexander and Rosenbaum d. Shafer and Smith, 9/7,6/4; Tilden and Richards d. Voshell and Biddle, 6/3,6/3; Behr and Steinkampf d. Post and Wagner, 6/3,10/8. SEMI-FINAL ROUND—Alexander and Rosenbaum d. Anderson and Anderson, 8/6,8/6; Tilden and Richards d. Behr and Steinkampf, 6/4,0/6,7/5. FINAL ROUND—William T. Tilden, Jr., and Vincent Richards d. Fred B. Alexander and William Rosenbaum, 6/4,3/6,6/2,2/6,6/1.

## National Indoor Women's Championships, 1919

By S. R. McALLISTER, NEW YORK.

Two Boston players, Mrs. George W. Wightman and Miss Marion H. Zinderstein, won the two titles at the national indoor women's championships, held as usual under the auspices of the Seventh Regiment Tennis Club at the armory in New York, March 10 to 14. Mrs. Wightman's greater tournament experience and superiority in the pinches were the factors that enabled her to defeat Miss Zinderstein in the final round of singles, and these two combined won the doubles without the loss of a set or being fully extended.

The absence of Miss Molla Bjurstedt, the titleholder, who was in Florida; of Miss Marie Wagner, six-time champion, and of Miss Eleanor Goss, runner-up in 1917 and 1918, made a big hole in the ranks of the singles contestants, but a strong Boston contingent aided in making the event a very interesting competition. The summaries:

### WOMEN'S SINGLES.

FIRST ROUND—Miss Phyllis Walsh d. Mrs. F. H. Godfrey, 2/6,6/3,7/5; Miss Helen Hooker d. Miss Florence Pond, 10/8,8/6; Mrs. George W. Wightman d. Miss Anna Morse, 6/0,6/0; Miss Clare Cassel d. Mrs. N. Dain, 6/0,6/0; Mrs. F. H. Cabot d. Mrs. H. F. Morse, 6/4,6/2; Mrs. H. S. Green d. Miss Adelaide Hooker, 6/2,6/1; Miss Caroma Winn d. Miss Helen Simpson, 6/3,8/6; Miss Betty Baker d. Mrs. G. B. Stanwix, 6/0,5/7,6/1; Mrs. M. B. Huff d. Miss Hazel Gardner, 6/1,6/4; Miss Florence Sheldon d. Miss Bessie Holden, 1/6,6/4,6/3. SECOND ROUND—Miss Walsh d. Miss Barbara Hooker, 6/3,6/4; Mrs. Wightman d. Miss Helen Hooker, 6/2,6/0; Mrs. E. C. Sohst d. Miss M. H. Taylor, 6/1,6/0; Miss Cassel d. Mrs. Cabot, 2/6,6/1,6/0; Mrs. Green d. Mrs. W. H. Pritchard, 6/2,6/1; Miss Winn d. Mrs. Percy Wilbourne, 6/3,6/1; Mrs. Huff d. Miss Baker, 6/2,6/3; Miss Marion H. Zinderstein d. Miss Sheldon, 6/1,6/0. THIRD ROUND—Mrs. Wightman d. Miss Walsh, 6/1,6/3; Miss Cassel d. Mrs. Sohst, 6/2,6/1; Mrs. Green d. Miss Winn, 6/0,4/6,6/2; Miss Zinderstein d. Mrs. Huff, 6/2,6/2. SEMI-FINAL ROUND—Mrs. Wightman d. Miss Cassel, 6/0,6/2; Miss Zinderstein d. Mrs. Green, 6/4,6/2. FINAL ROUND—Mrs. George W. Wightman d. Miss Marion H. Zinderstein, 2/6,6/1,6/4.

### WOMEN'S DOUBLES.

FIRST ROUND—Mrs. S. F. Weaver and Miss Eleanor Goss d. Miss M. H. Taylor and Mrs. S. W. McAnney, 6/2,6/1; Miss A. Hooker and Miss H. Hooker d. Miss N. Dain and Miss A. Morse, 6/1,6/0; Mrs. Wightman and Miss Zinderstein d. Miss Marie Wagner and Miss Clare Cassel, 6/3,6/4; Miss Phyllis Walsh and Mrs. T. C. Cassebeer d. Mrs. Vanderpool and Miss Simpson, 6/0,6/1; Mrs. Godfrey and Mrs. Cabot d. Mrs. Sohst and Miss Julie Brown, 6/2,6/3; Mrs. Green and Miss Natalie Browning d. Miss Winn and Miss Gertrude Della Torre, 4/6,6/2,6/3; Mrs. W. H. Pritchard and Miss Jessie Gott d. Miss Adele C. Cragin and Mrs. M. B. Huff, 6/1,6/4; Mrs. A. Humphries and Miss Bessie Holden d. Mrs. E. Van Winkle and Miss Emily Scott, 4/6,6/2,8/6. SECOND ROUND—Mrs. Weaver and Miss Goss d. the Misses Hooker, 6/2,6/1; Mrs. Wightman and Miss Zinderstein d. Miss Walsh and Mrs. Cassebeer, 6/1,6/1; Mrs. Green and Miss Browning d. Mrs. Godfrey and Mrs. Cabot, 7/5,10/8; Mrs. Humphries and Miss Holden d. Mrs. Pritchard and Miss Gott, 6/0,6/4. SEMI-FINAL ROUND—Mrs. Wightman and Miss Zinderstein d. Mrs. Weaver and Miss Goss, 6/4,6/0; Mrs. Humphries and Miss Holden d. Mrs. Green and Miss Browning, 6/3,5/7,6/2. FINAL ROUND—Mrs. George W. Wightman and Miss Marion H. Zinderstein d. Mrs. A. Humphries and Miss Bessie Holden, 6/1,6/1.

CONSOLATION SINGLES: Final Round—Mrs. W. H. Pritchard d. Miss Bessie Holden, 7/5,2/6,6/4.



NATHANIEL W. NILES,  
Boston.

CHARLES M. BULL, JR.,  
New York.

WALLACE F. JOHNSON,  
Philadelphia.

## New England Tournaments

### New England Championships

Walter Westbrook, a student at Harvard University and a promising young player, played tennis of a high order in the tournament for the New England championships, held at the Hartford (Conn.) Golf Club during the week of June 10, 1918, the result of which was that he placed both the singles and doubles honors to his credit, being ably assisted in the latter by R. L. James of Saratoga, N. Y.

Westbrook had no difficulty in disposing of G. W. Pike in the final round of singles, but he and his partner had considerable trouble in defeating F. McG. Bundy and L. H. Wiley in the final of the doubles, five sets being played before a decision was reached. The summaries:

#### MEN'S SINGLES.

FIRST ROUND—A. W. Merriam d. H. A. Redfield, 6/1,6/1; William T. Hooper d. Edward Guinan, 6/2,4/6,8/6; R. L. James d. J. W. Thurston, 6/2,6/3; F. McG. Bundy d. R. C. Rogers, 6/1,4/6,6/2; A. H. Chapin, Jr., d. Roger Grant, 6/1,5/7,6/2. SECOND ROUND—W. L. Wei d. J. J. Derwin, 7/5,6/4; Nicholas Fitzgerald d. E. R. Rerman, 6/1,6/0; A. H. Chapin d. Walter Roberts, 6/0,6/0; Walter Westbrook d. Seymour Peck, 6/1,6/2; R. R. Cook d. Richard Steele, 6/4,6/4; Merriam d. Hooper, 6/2,6/1; James d. Bundy, 9/7,6/4; A. H. Chapin, Jr., d. Samuel Snider, 6/0,4/6,6/2; L. H. Wiley d. E. V. Killeen, 6/4,6/1; R. E. Snow d. E. J. McDonald, 6/1,6/4; H. Broockmann d. E. S. Porter, 4/6,6/2,6/3. THIRD ROUND—Wei d. E. S. Chase, 6/8,9/7,6/2; A. H. Chapin d. Fitzgerald, 9/7,4/6,6/2; Westbrook d. V. Ely, 6/2,6/2; Merriam d. Cook, 6/4,6/0; A. H. Chapin, Jr., d. James, 6/3,3/6,6/3; G. W. Pike d. Snow, 6/8,6/3,6/4; Broockmann d. Holley, 6/0,6/0. FOURTH ROUND—A. H. Chapin d. Wei, 6/2,6/3; Westbrook d. Merriam, 6/1,6/4; Wiley d. A. H. Chapin, Jr., 4/6,10/8,6/1; Pike d. Broockmann, 6/3, 9/7. SEMI-FINAL ROUND—Westbrook d. A. H. Chapin, 7/5,6/2; Pike d. Wiley, 6/4, 2/6,9/7. FINAL ROUND—Westbrook d. G. W. Pike, 6/3,6/2,6/3.

#### MEN'S DOUBLES.

FIRST ROUND—Ely and Hooper d. E. W. Cole and Merriam, 6/4,4/6,6/0; Cook and T. E. Canfield d. W. Roberts and partner, 8/6,6/3; Wei and Broockmann d. Fitzgerald and E. V. Killeen, 6/1,6/4. SECOND ROUND—R. L. James and W. Westbrook d. E. S. Chase and R. S. Snow, 6/8,6/2,6/1; Allen and C. W. James d. Ely and Hooper, 4/6, 8/6,6/2; Wei and Broockmann d. Cook and Canfield, 6/3,6/0; Bundy and Wiley d. Chapin and Chapin, 4/6,6/1,8/6. SEMI-FINAL ROUND—R. L. James and Westbrook d. Allen and C. W. James, 6/2,6/2; Bundy and Wiley d. Wei and Broockmann, 4/6, 6/3,6/2. FINAL ROUND—R. L. James and W. Westbrook d. F. McG. Bundy and L. H. Wiley, 6/4,4/6,6/0,2/6,7/5.

## New England Intercollegiate Championships

Sharp competition was the rule in the tournament for the New England intercollegiate championship, held on the Longwood Cricket Club's courts, Boston, beginning May 13, 1918. E. H. Hendrickson of Amherst College won the singles, and W. Lock Wei, a crack Chinese player, and H. Broockmann of the Massachusetts Institute of Technology took the doubles. Hendrickson just managed to pull through in the singles, while the final of the doubles was stubbornly contested. The summaries:

#### MEN'S SINGLES.

FIRST ROUND—H. Broockmann d. F. Mathews, 6/4,6/4; R. R. Larmon d. D. E. Rockwell, 6/1,6/3; C. D. Fraker d. J. H. Powers, 6/4,6/4; J. B. Glenn d. E. H. Teifer, 6/4, 3/6,6/3; E. H. Hendrickson d. T. R. Stearns, 6/1,7/5; C. W. Sanders d. E. M. Puriinton, 10/8,6/1. SECOND ROUND—Broockmann d. C. P. Chin, 10/8,6/0; Larmon d. Fraker, 6/3, 6/3; Hendrickson d. Glenn, 8/6,6/0; W. Lock Wei d. Sanders, 12/10,5/7,6/2. SEMI-FINAL

ROUND—Broockmann d. Larmon, 6/4,5/7,6/3,9/11,6/3; Hendrickson d. Wei, 3/6,8/6,3/6,6/3, 14/12. FINAL ROUND—E. H. Hendrickson d. H. Broockmann, 4/6,6/2,6/4,6/4.

#### MEN'S DOUBLES.

FIRST ROUND—Hendrickson and Mathews d. Stearns and Chin, 7/5,3/6,6/3; Larmon and Sanders d. Rockwell and Telfer, 6/1,6/4; Wei and Broockmann d. Glenn and Fraker, 6/1,6/1. SEMI-FINAL ROUND—Purinton and Powers d. Hendrickson and Mathews, 2/6, 9/7,6/3; Wei and Broockmann d. Larmon and Sanders, 2/6,12/10,6/3. FINAL ROUND—W. Lock Wei and H. Broockmann d. E. M. Purinton and J. H. Powers, 4/6,6/3,6/4,7/5.

## Massachusetts State Championship

The twenty-fifth annual tournament for the Massachusetts State championship was decided, as usual, on the grass courts of the Longwood Cricket Club of Boston, beginning June 15, 1918. Nathaniel W. Niles came through to the challenge round by defeating Lawrence B. Rice, a freshman at Yale, the victory being in straight sets.

Many experts were of the opinion that Niles had the better chance of winning the title from the holder, Harry C. Johnson, but the latter showed he was the better player and deserved his victory. The summary:

#### MEN'S SINGLES.

FIRST ROUND—N. W. Niles d. C. B. Wilbur, 6,2,6,1; William P. Kimball d. M. J. Fitzgerald, 6/2,6/2; Horace Taylor d. O. C. Butts, 9,7,6/3; Edwin Sheafe d. Albert W. Leavitt, 6/4,6/2; C. O. Wellington d. H. P. Finck, 6,3,7/5; J. S. Nicholl d. T. S. Corcoran, 6/0,6/0; Lawrence Rice d. W. E. Porter, 6,4,1,6,6/3; S. L. Beals d. F. J. Goodridge, 6/3,6/2; J. B. Cook d. E. S. Waring, 4,6,6,4,6/1; A. N. Reggio d. G. C. Adams, 7/5,7/9,7/5; A. W. Blakemore d. W. Dice, 6/4,6,1; H. B. Bretz d. Crane, 6/1,6/1. SECOND ROUND—Niles d. M. T. Wendell, 6/3,6/0; Taylor d. Kimball, 6/4,4,6,6/2; R. C. Seaver d. Sheafe, 6,3,6/3; Nicholl d. Wellington, 6,3,6,3; L. Rice d. Beals, 2/6,6/4,6/4; Cook d. Richardson, 6,2,6/0; Reggio d. Blakemore, 6,0,4,6,6,1; Bretz d. W. L. Wei by default. THIRD ROUND—Niles d. Taylor, 6/0,6/2; Seaver d. Nicholl, 6,0,6/3; L. Rice d. Cook, 6/2,6,0; Reggio d. Bretz, 6/1,6/3. SEMI-FINAL ROUND—Niles d. Seaver, 6/0,3/6, 6/1; Rice d. Reggio, 6/4,5/7,6/4. FINAL ROUND—N. W. Niles d. L. Rice, 6/1,6/4,6/0.

CHALLENGE ROUND—Harry C. Johnson d. N. W. Niles, 6/4,6/4,0,6,6/3.

## Massachusetts State Doubles Championship

For the third successive time Irving C. Wright and Harry C. Johnson won the Massachusetts State doubles title on the clay courts of the Brae Burn Country Club, West Newton, near Boston, beginning May 30, 1918. They faced Nathaniel W. Niles and H. H. Bretz in the final round, and after the first set the latter pressed the winners to their utmost. The summary:

#### MEN'S DOUBLES.

FIRST ROUND—W. C. Porter and C. O. Wellington d. W. F. Vaughn and E. M. Buffan, 6/0,6/1; E. V. Page and R. W. Baker d. G. C. Scott and D. Hill, 6,0,6/1; Irving C. Wright and Harry C. Johnson d. A. P. Bryant and W. H. Hopkins, 6/2,8/6; W. Westbrook and Theodore Lightner d. A. C. Gould and G. B. McKinney, 6/3,6/1; Lawrence Rice and K. Simons d. J. A. Wiley and P. F. Monroe, 6/1,6/1. SECOND ROUND—W. F. Kimball and W. N. Barron d. W. D. Vickery and G. W. Chase, 3,6,6,4,11/9; N. W. Niles and H. H. Bretz d. H. Taylor and R. Currier, 6/2,6/0; W. C. Porter and C. O. Wellington d. F. C. Hannigan and L. A. Turume, 6/1,6/0; Wright and Johnson d. Page and Baker, 6/3,6/2; Westbrook and Lightner d. Rice and Simons, 6/8,6/4,6/4; W. L. Wei and H. Broockmann d. T. B. Plimpton and H. E. Kent, 4/6,7/5,6/4. THIRD ROUND—Niles and Bretz d. Kimball and Barron, 6/3,6/2; Porter and Wellington d. Benjamin and Rice, 7/5,6/4; Wright and Johnson d. Westbrook and Lightner, 7/9,6/4,6/3; W. H. Abbott and S. Beals d. Wei and Broockmann, 6/4,4/6,6/4. SEMI-FINAL ROUND—Niles and Bretz d. Porter and Wellington, 6/2,6/1; Wright and Johnson d. Abbott and Beals, 8/6,6/2. FINAL ROUND—Irving C. Wright and Harry C. Johnson d. N. W. Niles and H. H. Bretz, 6/2, 8/6,6/4.

## Longwood Women's Tournament

Miss Molla Bjurstedt showed her superiority at tennis in the women's tournament of the Longwood Cricket Club of Boston, held annually in September. In an excellent field of players in the singles, Miss Bjurstedt went through the competition without the loss of a set, but in the final she was extended almost to the limit by Mrs. George W. Wightman, particularly in the second set, which Miss Bjurstedt won, 10/8. Miss Bjurstedt paired with Miss Marion Zinderstein and captured the doubles from Mrs. Wightman and Miss Eleonora Sears, after losing the first set. The summaries:

### WOMEN'S SINGLES.

FIRST ROUND—Miss Mary Winson d. Miss Frances Jennings, 6,0,6/1; Mrs. A. C. Butler d. Miss Barbara Hooker, 6/1,3/6,6/4; Miss Marion Zinderstein d. Miss Cornelia Burgess, 6/0,6/1; Miss Helen Hooker d. Miss Lillian Coffin, 6/2,6/3; Miss Molla Bjurstedt d. Mrs. M. D. Shedden, 6,0,6/1; Miss Leslie Bancroft d. Mrs. N. W. Niles, 6/4,6/1; Mrs. A. A. Shurtleff d. Miss Adelaide Hooker, 6/1,6/2; Mrs. Frank Godfrey d. Mrs. Mary Hand, 6/0,6/4. SECOND ROUND—Miss Zinderstein d. Mrs. Butler, 6/1,6/1; Mrs. G. W. Wightman d. Miss Winsor, 6/2,6/1; Mrs. C. E. Magrane d. Miss Helen Hooker, 6,3,8/6; Mrs. Shurtleff d. Mrs. Godfrey, 6/2,7/5; Miss Bjurstedt d. Miss Bancroft, 6,0,6/1; Miss Eleonora Sears d. Mrs. J. E. Bailey, 6,1,6/1; Miss Florence A. Ballin d. Mrs. Joseph Warren, 6/2,6/3. THIRD ROUND—Mrs. Wightman d. Mrs. Crawford, 6,0,6/1; Miss Zinderstein d. Mrs. Magrane, 6/2,6,0; Miss Bjurstedt d. Mrs. Shurtleff, 6,0,6/2; Miss Sears d. Miss Ballin, 8/6,1/6,7/5. SEMI-FINAL ROUND—Mrs. Wightman d. Miss Zinderstein, 6,2,6,0; Miss Bjurstedt d. Miss Sears, 6,1,6/4. FINAL ROUND—Miss Molla Bjurstedt d. Mrs. G. W. Wightman, 6,1,10,8.

### WOMEN'S DOUBLES.

SEMI-FINAL ROUND—Mrs. George W. Wightman and Miss Eleonora Sears d. Miss Marion Fenno and Miss Osby, 6,1,6/2; Miss Molla Bjurstedt and Miss Marion Zinderstein d. Miss Barbara Hooker and Miss Helen Hooker, 6/1,6/1. FINAL ROUND—Miss Molla Bjurstedt and Miss Marion Zinderstein d. Mrs. George W. Wightman and Miss Eleonora Sears, 4,6,6,0,6,1.

HANDICAP SINGLES: Final Round—Mrs. Charles E. McGrane d. Miss Helen Hooker, 12/10,6/4. MIXED DOUBLES: Final Round—Miss Molla Bjurstedt and Nathaniel W. Niles d. Mrs. George W. Wightman and Harry C. Johnson, 6,3,9/7.

## New Hampshire State Championships

With good weather, an excellent class of entries, and tennis of a high order, the annual New Hampshire and White Mountains championships were decided during the week of July 30, 1918. George H. Sicard carried off the singles title by disposing of Edwin F. Torrey in the final round, but not until after four sets were played, while the doubles went to H. C. Johnson and W. H. Abbott, who defeated A. H. Brawner and O. G. Garbe after a good tussle in the final round. The summaries:

### MEN'S SINGLES.

FIRST ROUND—F. M. Fosdick d. J. G. Birnie, 6/2,6/4; A. H. Brawner d. H. S. Schley, 6/1,6/3; George H. Sicard d. W. H. Abbott, 0/6,6/1,7/5. SECOND ROUND—E. F. Torrey d. Fosdick, 6/0,6/3; O. G. Garbe d. C. B. Wilbar, 1/6,6/2,6/1; Brawner d. George E. Jonas, 6/3,8,6; Sicard d. P. C. Hart, 6/2,8/6. SEMI-FINAL ROUND—Torrey d. Garbe, 6/2,10/8; Sicard d. Brawner, 6/4,8/6. FINAL ROUND—George H. Sicard d. Edwin F. Torrey, 6/4,5/7,6/3,6/1.

### MEN'S DOUBLES.

SEMI-FINAL ROUND—A. H. Brawner and O. G. Garbe d. C. B. Schley and George E. Jonas, 6/2,6/2; H. C. Johnson and W. H. Abbott d. C. B. Wilbar and F. M. Fosdick, 6/0,6/1. FINAL ROUND—H. C. Johnson and W. H. Abbott d. A. H. Brawner and O. G. Garbe, 6/3,6/3,6/4.

CONSOLATION SINGLES: Final Round—W. H. Abbott d. C. B. Wilbar, 6/2,6/4.

## Connecticut State Championships

Although the entry list was not overly large there was some good tennis displayed in the tournament for the Connecticut State championships, held on the courts of the Norfolk Country Club, beginning July 30, 1918. The singles final developed into a four-set struggle between Lyle E. Mahan and Cedric A. Major, with the former getting the verdict. Mahan repeated his success in the doubles, C. J. Post, Jr., being his partner. They took the lead in the final after losing the first set, 0/6. The summaries:

### MEN'S SINGLES.

FIRST ROUND—R. L. James d. W. F. Stearns, 6/0,6/2; L. E. Mahan d. J. J. Derwin, 6/1,6/2; Cedric A. Major d. J. W. Anderson, 6/4,6/3. SECOND ROUND—E. J. McDonald d. R. W. Grant, 7/5,3/6,6/4; H. F. Davies d. F. B. Lund, 6/0,6/1; E. W. Peaslee d. G. B. Case, Jr., 6/1,7/5; Mahan d. James, 6/0,6/1; Major d. J. B. Macon, Jr., 6/0,6/1; E. S. Chase d. Dr. B. F. Drake, 8/6,5/7,6/1; J. D. Ewing d. L. G. Morris, 6/2,6/1; R. Spring d. Carroll J. Post, Jr., 6/3,9/7. THIRD ROUND—Davies d. McDonald, 7/5,6/2; Mahan d. Peaslee by default; Major d. Chase, 6/1,6/2; Ewing d. Spring by default. SEMI-FINAL ROUND—Mahan d. Davies, 4/6,6/3,6/3; Major d. Ewing, 6/3,6/2. FINAL ROUND—Lyle E. Mahan d. Cedric A. Major, 2/6,6/3,6/2,8/6.

### MEN'S DOUBLES.

FIRST ROUND—Ewing and Davies d. Grant and Morris, 6/2,6/2; Mahan and Post d. Lund and Macon, 6/0,6/0. SEMI-FINAL ROUND—James and Chase d. Ewing and Davies, 6/3,4/6,6/4; Mahan and Post d. Drake and John Janeway, 6/2,6/0. FINAL ROUND—Lyle E. Mahan and Carroll J. Post, Jr., d. R. L. James and E. S. Chase, 0/6, 8/6,6/4,6/2.

## Connecticut Valley Championships

Seven States were represented in the eleventh annual open tournament for the Connecticut Valley championships, held at the Country Club of Springfield, Mass, beginning June 24, 1918. Walter Westbrook, who had just won the New England title, was looked upon as a strong contender, but he was put out of the running in the semi-final round by R. Chauncey Seaver of the Longwood Cricket Club, the ultimate winner of the tournament. Westbrook and his partner, R. L. James, took the doubles. H. Broockmann won the consolation singles by default. The summaries:

### MEN'S SINGLES.

FIRST ROUND—Nell Chapin d. R. S. Ullery, 6/1,6/3; A. W. Merriam d. A. M. Fletcher, 6/1,6/1. SECOND ROUND—W. Westbrook d. Dr. J. F. Ager, 6/1,6/2; A. C. Gammons d. A. H. Chapin, 3/6,14/12,7/5; E. S. Chase d. C. Blinn, 6/0,6/0; Ralph Oatley d. H. Robinson, 6/3,3/6,6/4; Neil Chapin d. Giles Blague, 6/3,6/4; R. C. Seaver d. Merriam, 6/1,6/3; R. L. Cheney d. R. E. Snow, 6/3,3/2. THIRD ROUND—H. A. Buzzell d. T. J. Jefferson, Jr., 6/3,3/6,6/4; Westbrook d. F. H. Bickley, 6/1,6/3; A. H. Chapin, Jr., d. R. L. James, 2/6,9/7,6/2; Seaver d. N. Chapin, 6/3,6/0; Cheney d. Gammons, 6/1,6/3; Chase d. H. Barger by default; G. W. Pike d. Oatley, 6/1,6/0. FOURTH ROUND—Westbrook d. Buzzell, 6/2,6/2; Seaver d. A. H. Chapin, Jr., 6/3, 7/5; Cheney d. H. Broockmann, 2/6,6/4,6/2; Pike d. Chase, 6/3,9/7. SEMI-FINAL ROUND—Seaver d. Westbrook, 6/2,6/3; Pike d. Cheney, 6/3,7/5. FINAL ROUND—R. C. Seaver d. G. W. Pike, 6/4,6/3,6/1.

### MEN'S DOUBLES.

SEMI-FINAL ROUND—Westbrook and James d. Cheney and Gammons, 8/6,6/3; Capt. H. L. Davenport and R. H. Paige d. Chase and Snow, 7/5,6/3. FINAL ROUND—W. Westbrook and R. L. James d. Capt. H. L. Davenport and R. H. Paige, 6/8, 6/2,6/2,7/5.



**Southern Maine Championships.**—The Squirrel Island Athletic Association held its customary tournament to decide the championship of Southern Maine, beginning August 24, 1918. The entry was small, but enthusiasm overcame this difficulty and a successful meeting was held. Stewart Johnson of Montclair, N. J., won the singles, experiencing little difficulty until reaching the final round, where Kimball Fisher of Augusta, Me., forced him to display all his skill and resourcefulness to win. The score was 5/7, 6/3, 6/4, 8/6. Fisher revenged himself for his defeat by winning the doubles, where, ably partnered by Leigh Flint, also of Augusta, he defeated Johnson and William Stanwood of Wellesley, Mass., 4/6, 6/3, 6/3, 6/3. Miss Florence Hayes won three matches in the women's singles, defeating in the final round, Mrs. George Kelly, 6/3, 6/3.

**East Side of White Mountains Tournament.**—The tournament for the championships of the East Side of the White Mountains on the Iron Mountain Tennis Club's courts, Jackson, N. H., beginning August 5, 1918, attracted a good field of competitors, and the playing was keen and satisfactory. The singles brought to the final round J. D. Ewing and W. Herbert Abbott, and after the hardest kind of a battle, Ewing emerged the winner, after losing the first two sets. The scores were 3/6, 4/6, 6/1, 7/5, 6/3. These two players won the doubles, defeating Louis F. Baker and J. B. Keyes in the final, 7/5, 10/8, 6/3. The match between Baker and Keyes against J. G. Birnie and P. C. Hart, which was won by the former, 6/4, 4/6, 21/19, took three hours and fifteen minutes to play. Baker and Keyes were within one point of winning the match four times and the losers were within one point of winning once.

**Iron Mountain Tournament.**—J. D. Ewing of Yonkers, N. Y., showed some excellent tennis in the 1918 Iron Mountain tournament, held by the Iron Mountain Lawn Tennis Club of Jackson, N. H., during the week of August 5. He won the singles after losing the first two sets to W. H. Abbott in the final round, 3/6, 4/6, 6/1, 7/5, 6/3. These two men paired annexed the doubles, winning from L. F. Baker and B. Keyes in the final, 7/5, 10/3, 6/3.

**Springfield (Mass.) Championships.**—Raymond E. Snow, after eight years of unsuccessful endeavor, won the Springfield city championship, held the latter part of September. Snow owed his victory to improved playing and more aggressive tactics. His opponent in the final, Captain H. L. Davenport, played well, but lost most of the rallies. Snow won in straight sets, 6/3, 6/2, 6/4. Captain Davenport and Ralph H. Paige defeated R. E. Snow and A. H. Hastings, 6/3, 6/3, 7/5, in the doubles final.

**Worcester (Mass.) Open Tournament.**—Horace Taylor and Edwin Sheafe, both members of the Longwood Cricket Club of Boston, fought it out for the singles title in the open tournament promoted by the Worcester Tennis Club, beginning August 3, 1918. When the smoke of the battle had cleared away, Taylor was found to have been victorious, 6/3, 10/8, 9/7.

**Greenwich (Conn.) Invitation Tournament.**—Only doubles was played in the tournament held by the Field Club of Greenwich, July 26 to 28, 1918, but a high class entry was secured and the tournament proved a decided success. From a field comprising Miss Molla Bjurstedt, Mrs. George W. Wightman, Miss Eleanor Goss, Miss Marion Zinderstein, Miss Marie Wagner, Mrs. H. S. Green, Mrs. de Forest Candee and Miss Florence A. Ballin, the Bjurstedt Wightman combination came through without losing a set. They defeated Mrs. Wightman and Miss Zinderstein in the final round, 6/4, 6/1. The men's doubles was no less noteworthy, Fred Alexander and Beals Wright emerging victors over Theodore Roosevelt Pell and Nathaniel W. Niles in the final round, after being a set down and 3/5 in the second. Score, 2/6, 7/5, 6/3. The mixed doubles brought forth some well contested matches. Miss Zinderstein and W. Merrill Hall defeated Miss Goss and Niles in two 9/7 sets, but went down before Miss Bjurstedt and Alexander in a three-set match. The final round proved disappointing, Mrs. Wightman and Beals Wright losing to Miss Bjurstedt and Alexander in straight sets, 9/7, 6/0. The meeting was brought to a close by an interesting single set exhibition between Miss Bjurstedt and Mrs. Wightman, the former winning, 9/7.

**Rhode Island State Clay Court Championship.**—Rhode Island's stellar tennis attraction during 1918 was the open clay court championship, held on the East Side Tennis Club's courts at Providence in September. The final round of singles resulted in a brilliant racket battle between C. K. Shaw of Providence and Russell N. Dana, holder of the State title, Shaw getting the verdict by 6/3, 3/6, 6/4, 8/6. There were twenty-eight players in action, and of the five matches he contested, Shaw lost but two sets, one each to H. Y. Stites and Dana.

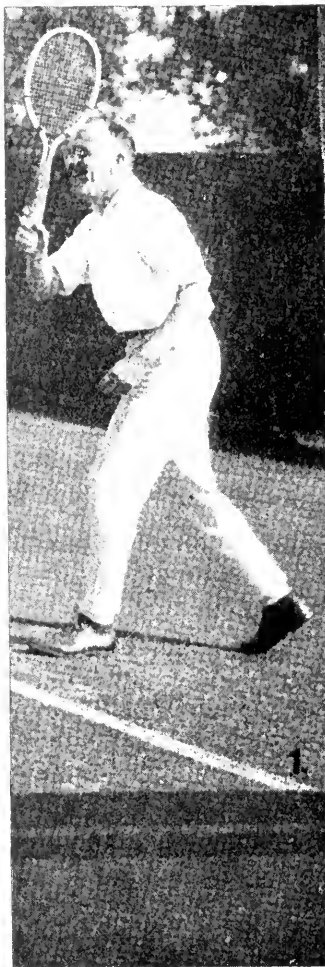

WALTER MERRILL HALL,  
New York,  
Middle States Champion.



ICHIYA KUMAGAE,  
New York,  
New York State Champion.

Photos © by Corte-Scope Co., Cleveland, O.

# Middle States Tournaments

## Middle States Championships

Play was resumed for the Middle States championships during the week of June 24, 1918, at the Orange Lawn Tennis Club, Mountain Station, N. J. The entry was a good one, the play interesting and the management excellent. Walter Merrill Hall of New York came through the tournament and challenged the standing-out champion, Theodore Roosevelt Pell, and defeated him in straight sets. The doubles went to Dr. William Rosenbaum and E. A. Clark after a good four-set match in the final.

Mrs. Homer S. Green, formerly Miss Adelaide Browning, won the women's singles title after defeating Miss Marie Wagner in the second round. The two sisters, Mrs. Green and Miss Natalie Browning, won the doubles quite easily. The summaries:

### MEN'S SINGLES.

FIRST ROUND—Harry N. Balch d. C. A. Brown, 6/1,6/3; B. Arnold d. G. E. McLean, 6/2,6/1; Lindsay Dunham d. T. C. Corwin, 6/2,8/6; David George d. Russell Kingman, 8/6,7/5. SECOND ROUND—G. A. L. Dionne d. George Dixon, 6/1,6/1; F. W. Elmendorf d. Norman Johnson, 6/3,6/3; R. P. Bennett d. C. A. Anderson, 6/2,2/6,6/0; Vincent Arguimbau d. W. N. Richard, 6/3,6/3; S. Kashio d. H. M. Wood, 6/1,6/2; Dr. William Rosenbaum d. Balch, 6/2,6/3; Arnold d. D. T. Moorhead, 6/4,6/4; Dunham d. A. R. Kaiser, 6/2,6/2; Allen Behr d. Malcolm Scott, 6/0,6/3; George d. Auguste Roche, Jr., 6/2, 6/2; H. W. Holbrook d. G. Colby, 6/0,6/2; G. W. Gilmore d. Dr. W. R. Widmer, 6/4,6/4; Carl C. Russell d. A. G. Deane, 4/6,6/0,6/1; W. M. Hall d. A. C. Bragaw, 6/1,6/4. THIRD ROUND—Dionne d. Elmendorf, 6/0,6/1; Bennett d. Arguimbau, 6/1,6/3; Kashio d. Magary, 6/0,6/1; Rosenbaum d. Arnold, 6/2,6/1; Dunham d. Behr, 6/2,8/6; Holbrook d. George, 8/6,4/6,6/4; Gerald Emerson d. Gilmore, 6/3,6/1; Hall d. Russell 6/0,6/0. FOURTH ROUND—Dionne d. Bennett, 5/7,8/6,6/3; Kashio d. Rosenbaum, 6/1,6/2; Dunham d. Holbrook, 6/4,6/4; Hall d. Emerson, 6/3,6/1. SEMI-FINAL ROUND—Kashio d. Dionne, 6/1, 6/1; Hall d. Dunham, 6/3,4/6,6/0. FINAL ROUND—W. M. Hall d. Seiichiro Kashio, 3/6, 6/2,6/3,3/6,7/5.

CHALLENGE ROUND—W. M. Hall d. T. R. Pell, 6/2,6/2,6/0.

### MEN'S DOUBLES.

FIRST ROUND—Emerson and H. Taylor d. Bennett and R. Colgate, 6/4,6/4. SECOND ROUND—T. C. Corwin and George d. G. Colby and Arnold, 4/6,6/2,6/3; Rosenbaum and E. A. Clark d. Balch and Kingman, 6/0,3/6,6/3; Emerson and Taylor d. Dixon and G. McLean, 6/3,3/6,6/4; Kashio and Behr d. A. C. Bragaw and Roche, 6/2,7/5. SEMI-FINAL ROUND—Rosenbaum and Clark d. C. Chambers and Elmendorf, 6/1,4/6,6/3; Kashio and Behr d. Emerson and Taylor, 6/3,7/5. FINAL ROUND—Dr. William Rosenbaum and E. A. Clark d. S. Kashio and Allen Behr, 3/6,6/4,6/4,8/6.

### WOMEN'S SINGLES.

FIRST ROUND—Miss Gertrude Della Torre d. Miss Helen McAuslan, 7/5,6/4; Miss Bessie Holden d. Mrs. L. J. Murray, 6/1,6/2. SECOND ROUND—Miss Helene Pollak d. Miss Caroma Winn, 6/8,7/5,6/4; Miss Natalie Browning d. Mrs. D. C. Mills, 7/5,6/4; Mrs. R. C. Miller d. Miss Della Torre, 6/4,6/1; Miss Holden d. Mrs. T. Waring, 6/2,6/1; Mrs. Homer Green d. Miss Marie Wagner, 7/5,3/6,6/0; Miss Joyce Hansel d. Miss Florence Pond, 6/0,6/2. THIRD ROUND—Miss Pollak d. Mrs. Lynch, 6/0,6/3; Miss Browning d. Mrs. Miller, 6/2,6/2; Miss Holden d. Mrs. Pritchard, 7/5,6/4; Mrs. Green d. Miss Hansel, 6/1,6/2. SEMI-FINAL ROUND—Miss Browning d. Miss Pollak, 7/5,6/1; Mrs. Green d. Miss Holden, 6/1,6/0. FINAL ROUND—Mrs. Homer S. Green d. Miss Natalie Browning, 6/2,4/6,6/0.

### WOMEN'S DOUBLES.

FIRST ROUND—Miss Della Torre and Miss Winn d. Mrs. William G. Chapman and Miss M. Chapman, 6/2,7/5; Mrs. Pritchard and Mrs. Waring d. Mrs. Murray and Miss McAuslan, 6/2,7/5; Mrs. Green and Miss Browning d. Mrs. Miller and Miss Hansel, 6/2, 6/2. SECOND ROUND—Mrs. Mills and Miss Wagner d. Miss Scheerer and Mrs. Nichols, 6/3,6/1; Miss Della Torre and Miss Winn d. Mrs. Pritchard and Mrs. Waring, 6/2, 7/5; Mrs. Green and Miss Browning d. Mrs. Humphries and Miss Holden, 6/3,3/6,6/4; Miss Clare Cassel and Miss Pollak d. Mrs. Lynch and Miss Moore, 6/2,6/4. SEMI-FINAL ROUND—Mrs. Mills and Miss Wagner d. Miss Della Torre and Miss Winn, 3/6,6/3,6/1;

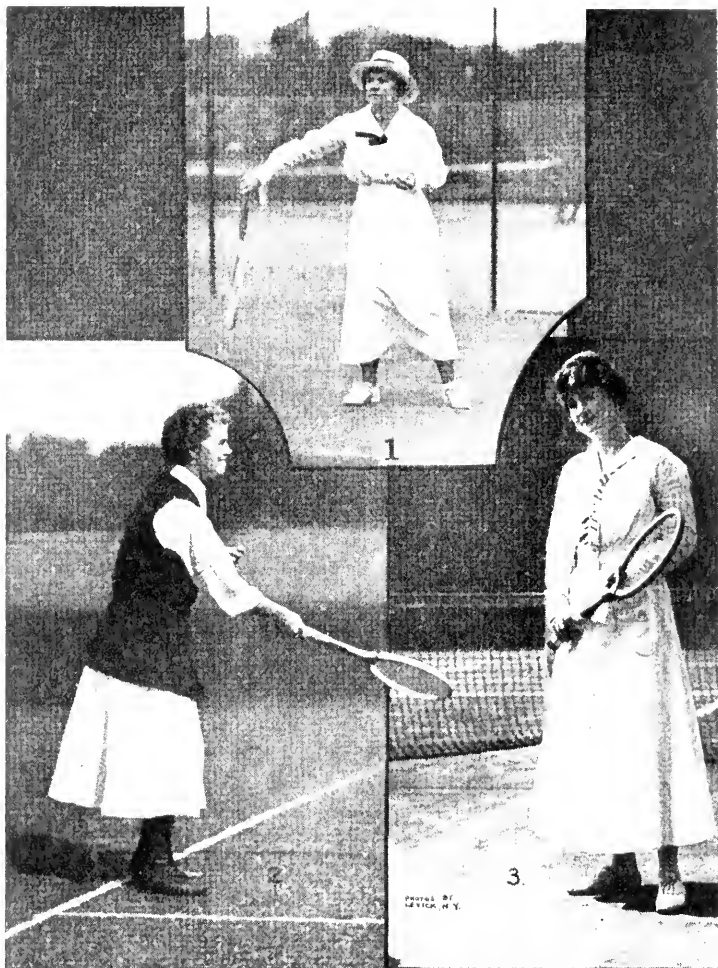

1, Mrs. H. F. Morse (Marion Vanderhoef), New York. 2, Miss Eleonora Sears, Boston. 3, Mrs. V. C. Hitchins, New York.

Mrs. Green and Miss Browning d. Miss Cassel and Miss Pollak, 8/6,7/5. FINAL ROUND—Mrs. Homer S. Green and Miss Natalie Browning d. Mrs. D. C. Mills and Miss Marie Wagner, 6/1,6/3.

MIXED DOUBLES: Final Round—Miss Bessie Holden and David George d. Miss L. Scheerer and E. A. Clark, 4/6,6/3,9/7.

## Metropolitan Championships

The Metropolitan championships, held under the auspices of the Crescent Athletic Club on its turf courts at Bay Ridge, Brooklyn, during the week of July 29, 1918, produced new singles and doubles champions. In the singles, Ichiya Kumagae, the famous Japanese player, now a resident of New York City, supplanted George M. Church, and in the doubles, Dr. William Rosenbaum and Fred C. Baggs secured the title carried off by Church and Dean Mathey in 1916. Seiichiro Kashio, another clever Japanese player who also has made New York his residence, following his defeat of Baggs in the second round, was taken ill and had to default in both singles and doubles.

Kumagae's opponent in the final round of singles was Harold L. Taylor of Brooklyn. The latter started well, but later became very erratic at the net, and although he tried everything, it was of no avail. Kumagae proved entirely too good for the youngster and won in straight sets. The doubles, as anticipated, was taken by Dr. Rosenbaum and Baggs, who administered a decisive defeat to Charles Chambers and Henry Mollenhauer in the final round.

The competition in the early part of the week was somewhat handicapped by rain, but the excellent management enabled the players to finish on Sunday. The summaries:

### MEN'S SINGLES.

FIRST ROUND—Elliott H. Binzen d. G. A. L. Dionne, 6/3,3/6,6/3; R. D. Ritchey d. Walter L. Bate, 1/6,7/5,3/4 (default); Alexander Iler d. Edgar Dawson, 6/2,7/5; Dr. W. H. Ross d. Lyman Tremaine, 9/7,6/1; H. J. W. Morgenthaler d. Harold Somers, 6/3,6/2; Francis Middleditch d. H. H. Neale, 6/2,6/1; Charles Chambers d. R. Howard Boggs, 6/2,6/1; Harold Taylor d. Percy L. Kynaston, 6/3,6/4; Frank Danielson d. Gerald Donaldson, 6/3, 6/4; E. Hendrickson d. Frank A. Fall, 4/6,9/7,6/0; W. A. Hartye d. Jay Anderson, 6/1, 6/2. SECOND ROUND—C. G. Burrows d. P. Schmidt, 6/0,6/1; E. F. Thomas, Jr., d. M. E. Macksoud, 6/2,6/1; Vincent Richards d. Fred Anderson, Jr., 4/6,6/2,6/4; Dr. William Rosenbaum d. Cecil Donaldson, 6/1,6/2; Ichiya Kumagae d. George S. Groesbeck, 6/1,6/0; Binzen d. Ritchey, 6/1,6/3; Iler d. Ross, 12/10,6/4; Morgenthaler d. Middleditch, 9/7,8/10, 6/3; Chambers d. Danielson, 6/4,6/2; Taylor d. Herbert L. Bowman, 6/2,6/3; Ned Cumming d. Hendrickson, 2/6,6/4,6/2; Hartye d. H. B. O'Boyle, 6/4,6/2; J. S. O'Boyle d. H. R. Burroughs, 6/3,6/2; George King d. Fred G. Anderson, 6/2,3/6,6/4; Seiichiro Kashio d. Fred C. Baggs, 6/3,6/4; J. B. Hughes d. Gerald Donaldson, 6/1,6/2. THIRD ROUND—Burrows d. Thomas, 2/6,6/1,7/5; Richards d. Rosenbaum by default; Kumagae d. Binzen, 6/1,6/0; Morgenthaler d. Iler, 6/3,6/1; Taylor d. Chambers, 1/6,7/5,8/6; Hartye d. Cumming, 4/6,6/2,6/1; King d. J. S. O'Boyle, 6/0,6/2; Kashio d. Hughes, 6/1,6/1. FOURTH ROUND—Richards d. Burrows, 2/6,6/3,6/1; Kumagae d. Morgenthaler, 6/3,6/1; Taylor d. Hartye, 6/0,6/0; Kashio d. King, 6/4,3/6,6/1. SEMI-FINAL ROUND—Kumagae d. Richards, 6/2,6/2,6/3; Taylor d. Kashio by default. FINAL ROUND—Ichiya Kumagae d. Harold Taylor, 6/2,6/3,6/2.

### MEN'S DOUBLES.

FIRST ROUND—Charles Chambers and H. Mollenhauer d. Gerald Donaldson and Schmitt, 6/4,6/2; Kumagae and Kashio d. King and Thomas, 6/4,6/2; Hughes and Hendrickson d. Tremaine and Middleditch, 4/6,6/2,6/1. SECOND ROUND—J. S. O'Boyle and Binzen d. Hartye and Davis, 6/2,6/1; Ritchey and Cecil Donaldson d. Iler and H. B. O'Boyle, 1/6,6/3,6/4; Morgenthaler and Dionne d. J. S. Myrick and W. B. Campbell, 6/3, 4/6,7/5; Chambers and Mollenhauer d. Richards and Taylor, 6/4,1/6,6/3; Fall and Groesbeck d. Kumagae and Kashio by default; Anderson and Burrows d. Hughes and Hendrickson, 7/5,6/2. THIRD ROUND—Ritchey and Donaldson d. Morgenthaler and Dionne, 3/6,7/5,6/4; Chambers and Mollenhauer d. Fall and Groesbeck, 6/2,6/3; Anderson and Burrows d. J. S. O'Boyle and Binzen, 8/6,2/6,6/2; Rosenbaum and Baggs d. Gerald Donaldson and Jay Anderson, 6/1,6/3. SEMI-FINAL ROUND—Chambers and Mollenhauer d. Ritchey and Donaldson, 7/5,6/3; Rosenbaum and Baggs d. Anderson and Burrows, 6/2,6/1. FINAL ROUND—Dr. William Rosenbaum and Fred C. Baggs d. Charles Chambers and H. Mollenhauer, 6/3,6/2,6/1.

## Metropolitan Women's Championships

Miss Molla Bjurstedt won for the third successive time the Metropolitan women's championship, held by the West Side Tennis Club, beginning June 10, 1918, thus gaining possession of the Mrs. Barger Wallach Challenge Cup. Miss Marie Wagner and Miss Clare Cassel won the doubles, while the mixed went to Miss Marion Zinderstein and W. M. Hall.

A very good entry was received, including Mrs. Theodore Cassebeer, Mrs. Rawson Wood, Miss Cassel, Miss Goss and Miss Zinderstein, yet no one succeeded in obtaining a set from the national champion. Miss Hooker came through three rounds, but was able to gain only one game from Miss Bjurstedt, Miss Cassel doing a little better with three. But there were several good battles among the other contestants. Mrs. Lynch took a set from Miss Zinderstein, and Mrs. Rogge from Miss Pollock. The surprise of the meeting was Miss Pollock's victory over Miss Zinderstein, her steady play proving too much for the brilliant Bostonian. As was expected, Miss Goss won easily from Miss Pollock, and Miss Bjurstedt from Mrs. Wood, though the champion was forced to play one deuce set. The final was too one-sided to be interesting. Miss Goss tried everything she knew, but it was Miss Bjurstedt's match from start to finish.

In the doubles, Miss Bjurstedt and Mrs. Rogge came through to the semi-finals by wins over Mrs. Wood and Mrs. Weaver and Miss Della Torre and Miss Winn, but went down in straight sets to Miss Cassel and Miss Wagner, who were right on edge. The winners, continuing their good work, took the final from Mrs. Candee and Mrs. Cassebeer with equal facility.

The mixed doubles produced an interesting final, in which Miss Bjurstedt and F. B. Alexander lost to Miss Zinderstein and W. M. Hall in a close match. The winners were aggressive and heady and combined excellently. The summaries:

### WOMEN'S SINGLES.

FIRST ROUND—Miss H. Hooker d. Mrs. Lyle E. Mahan, 6/1,4/6,6/4; Mrs. J. Zohst d. Mrs. Percy Wilbourne, 6/4,7/5. SECOND ROUND—Miss C. Winn d. Miss Barbara Hooker, 6/2,6/3; Mrs. Rawson Wood d. Mrs. E. C. Doble, 6/0,6/1; Miss Clare Cassel d. Mrs. Theodore Cassebeer, 1/6,6/2,6/1; Miss Molla Bjurstedt d. Mrs. A. Chisholm, 6/0,6/0; Mrs. S. F. Weaver d. Mrs. N. M. Maclay, 6/3,6/3; Miss H. Hooker d. Miss Gott, 6/4,9/11,7/5; Miss Eleanor Goss d. Miss A. Hooker, 6/2,6/0; Miss Bessie Holden d. Mrs. H. Vogel, 6/1,6/0; Miss P. Davies d. Miss T. Blum, 4/6,9/7,6 1; Miss Marion Zinderstein d. Mrs. J. Straus, 6/3,6/0; Mrs. E. Lynch d. Mrs. Mabel D. Straffin, 6/1,6/1; Miss Helene Pollak d. Mrs. D. C. Mills, 6/4,8/6; Mrs. J. Rogge d. Mrs. L. Bailey, 6/1,6/0. THIRD ROUND—Mrs. Pope d. Miss Winn, 0/6,6/3,6/4; Mrs. Wood d. Mrs. H. Pritchard, 6/1,6/1; Miss Bjurstedt d. Miss Cassel, 6/2,6/1; Miss H. Hooker d. Mrs. Weaver by default; Miss Goss d. Mrs. Zohst, 6/3,6/0; Miss Holden d. Miss Davies, 7/5,2/6,7/5; Miss Zinderstein d. Mrs. Lynch, 6/1,4/6,6/2; Miss Pollak d. Mrs. Rogge, 6/2,1/6,6/2. FOURTH ROUND—Mrs. Wood d. Mrs. Pope, 6/2,6/3; Miss Bjurstedt d. Miss H. Hooker, 6/1,6/0; Miss Goss d. Miss Holden, 6/2,6/1; Miss Pollak d. Miss Zinderstein, 4/6,6/2,6/3. SEMI-FINAL ROUND—Miss Bjurstedt d. Mrs. Wood, 6/1,7/5; Miss Goss d. Miss Pollak, 6/2,6/1. FINAL ROUND—Miss Molla Bjurstedt d. Miss Eleanor Goss, 6/2,6/3.

### WOMEN'S DOUBLES.

FIRST ROUND—Mrs. Cullman and Mrs. Garson d. Miss Gott and Mrs. K. Thompson, 7/5,6/1. SECOND ROUND—Miss Gertrude Della Torre and Miss Winn d. Miss J. Brown and Mrs. R. Jenkins, 6/3,6/1; Miss Bjurstedt and Mrs. Rogge d. Mrs. Weaver and Mrs. Wood, 6/1,7/5; Miss Wagner and Miss Cassel d. Mrs. Cullman and Mrs. Garson, 6/1,6/2; Mrs. Humphries and Miss Holden d. Mrs. Wilbourne and Mrs. Ingo Hartmann, 6/2,6/1; Mrs. Candee and Mrs. Cassebeer d. Miss Davies and Miss A. Hooker, 6/2,6/0; Miss E. H. White and Miss M. Curry d. Miss B. Hooker and Miss H. Hooker, 6/2,6/9; Miss S. Waring and Miss A. C. Cragin d. Mrs. Rossman and Mrs. Doble, 6/0,9/7. THIRD ROUND—Miss Bjurstedt and Mrs. Rogge d. Miss Della Torre and Miss Winn, 6/2,6/8,6/3; Miss Wagner and Miss Cassel d. Miss Zinderstein and Miss Pollak, 6/4,6/1; Mrs. Candee and Mrs. Cassebeer d. Mrs. Humphries and Miss Holden, 6/2,4/6,6/4; Miss White and

Miss Curry d. Miss Waring and Miss Cragin, 6/1,6/0. SEMI-FINAL ROUND—Miss Wagner and Miss Cassel d. Miss Bjurstedt and Mrs. Rogge, 6/3,6/4; Mrs. Candee and Mrs. Cassebeer d. Miss White and Miss Curry, 6/1,7/5. FINAL ROUND—Miss Marie Wagner and Miss Clare Cassel d. Mrs. Candee and Mrs. Theodore Cassebeer, 6/4,6/2.

MIXED DOUBLES: Final Round—Miss Marion Zinderstein and W. Merrill Hall d. Miss Molla Bjurstedt and F. B. Alexander, 6/4,2,6,6/4.

## Southampton Invitation Tournament

William T. Tilden, Jr., went through a field of formidable players, including R. Lindley Murray, T. R. Pell, Harold Throckmorton and Ichiya Kumagae, at the annual invitation tournament of the Meadow Club, Southampton, N. Y., during the week of August 19, 1918, and placed to his credit both the singles and doubles honors. He defeated Pell in a cleverly played match in the final of the singles, and he and young Vincent Richards, who had won the national doubles championship the previous week, also won the doubles. The summaries:

### MEN'S SINGLES.

FIRST ROUND—Elliott Binzen d. A. S. Cassils, 6/2,6/0; W. T. Hayes d. H. D. Kersey, 6/0,6/0; Seiichiro Kashio d. Alexander Iler, 6/1,6/0; Ichiya Kumagae d. J. S. O'Boyle, 6/0,6/0; Harold Throckmorton d. J. B. Hughes, 6/2,6/1; Dr. William Rosenbaum d. Lieut. W. A. Horrell, 6/4,6/4; C. B. Doyle d. E. F. Thomas, 6/1,6/4; Ralph Burdick d. H. S. O'Boyle, 6/2,6/4; W. M. Hall d. Harold Taylor, 6/2,6/2; W. T. Tilden, Jr., d. E. H. Hendrickson, 6/3,7/5; H. H. Bassford d. George A. Walker, Jr., 7,5,6/4; Vincent Richards d. F. C. Baggs, 7/5,2,6,6/2. SECOND ROUND—Hayes d. Binzen, 6/4,7/5; Kumagae d. Kashio, 6/1,7/5; Throckmorton d. Emerson, 6/1,6/4; T. R. Pell d. Rosenbaum, 6/1,6/4; Burdick d. Doyle, 7/5,6/4; Tilden d. Hall, 4,6,8,6,10/8; R. L. Murray d. Hooker, 6/0,6/1; Richards d. Bassford, 6/2,8/6. THIRD ROUND—Hayes d. Kumagae, 6/4,6/4; Pell d. Throckmorton, 6/3,6/2; Tilden d. Burdick, 1,6,7,5,6/2; Murray d. Richards, 6/1,6/3. SEMI-FINAL ROUND—Pell d. Hayes, 6/2,7/5; Tilden d. Murray, 6/3,6/3. FINAL ROUND—William T. Tilden, Jr., d. Theodore R. Pell, 6/4,6/2,6/4.

### MEN'S DOUBLES.

FIRST ROUND—Doyle and Horrell d. Binzen and J. S. O'Boyle, 6/4,6,8,6/2; Tilden and Richards d. E. Thomas and J. Hughes, 6/3,6/1; Kashio and Emerson d. Walker and Bassford, 3/6,6/4,6/2; Throckmorton and Hall d. Rosenbaum and Baggs, 6/3,6/1; Kumagae and Taylor d. Cassils and Soune, 6/2,6/1; Hayes and Burdick d. Hendrickson and Kersey, 6/1,6/1. SECOND ROUND—Tilden and Richards d. Doyle and Horrell, 6/3,6/4; Throckmorton and Hall d. Kashio and Emerson, 6/4,6/2; Hayes and Burdick d. Kumagae and Taylor, 6/2,6/1; Murray and Pell d. H. S. O'Boyle and Iler, 6/2,6/1. SEMI-FINAL ROUND—Tilden and Richards d. Throckmorton and Hall, 6/3,6/4; Hayes and Burdick d. Murray and Pell, 2,6,6/4,7/5. FINAL ROUND—William T. Tilden, Jr., and Vincent Richards d. Walter T. Hayes and Ralph H. Burdick, 6/4,1,6,6/3,5,7,6/4.

## Pelham Country Club

Miss Molla Bjurstedt again won the singles in the women's invitation tournament, held annually by the Pelham Country Club, Pelham, N. Y. Miss Marie Wagner and Mrs. H. S. Green won the doubles, while the mixed fell to Miss Florence Ballin and William Tilden, Jr.

Play began May 28, 1918, and continued throughout the week despite distressing weather. There was plenty of good tennis, especially in the mixed doubles, in which four men from the Naval Station participated—H. B. and J. S. O'Boyle, A. Iler and J. M. Hughes.

Miss Bjurstedt had no difficulty in winning any of her matches, while her opponent in the final, Mrs. Edward Raymond, had hard tussles with Miss Cassel and Mrs. Wood. In the doubles, Miss Bjurstedt and Mrs. Rogge, after losing a set to Mrs. Wood and Mrs. Weaver, reached the final, where by a curious score they were defeated by Miss Wagner and Mrs. Green, 0/6,6/0,1/6.

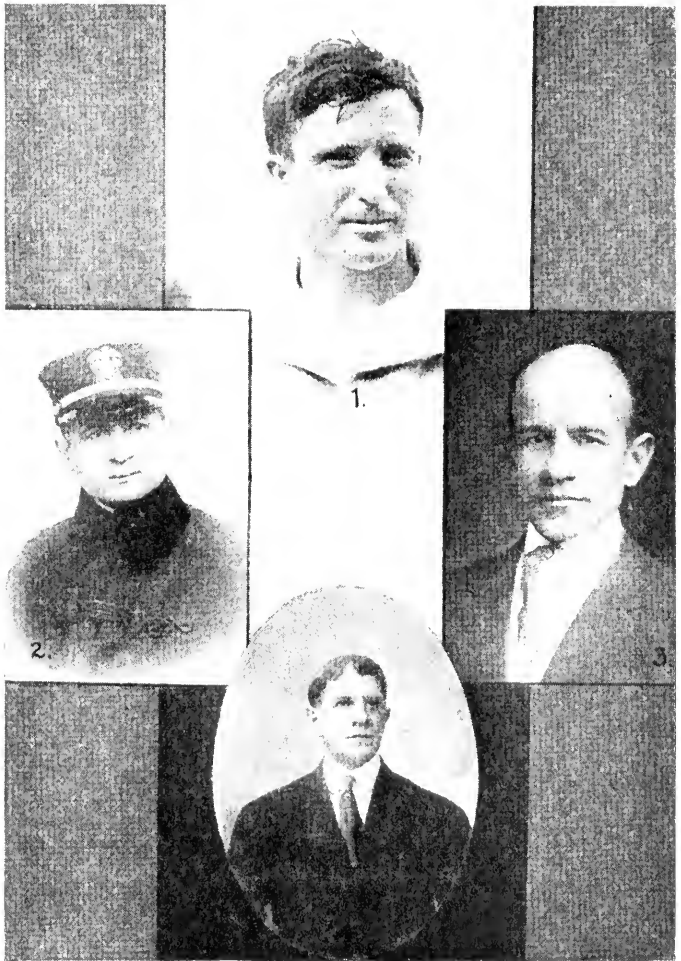

1. Thomas C. Bundy, Los Angeles, Cal. 2. Joseph J. Armstrong, Philadelphia.  
3. A. L. Hoskins, Philadelphia. 4. William Cunningham, Seventh Regiment  
Tennis Club, New York.



## New York State Championships

Ichiya Kumagae, the skillful Japanese player, successfully defended his title as New York State champion at the tournament held on the courts of the Yahundasis Golf Club, Utica, from July 17 to 20, 1918. By unanimous consent of the contestants the conditions of the competition were so changed that instead of the champion being required to play through, he was asked only to meet the tournament winner in a challenge round.

Seiichiro Kashio, Kumagae's fellow-countryman, showed himself to be the best player in the tournament. When he faced Kumagae in the challenge round, however, he found the going much rougher, as after winning the first set he lost the next three and the championship.

The doubles was cleverly won by Irving C. Wright and T. C. Fulton from Frank T. Anderson and Harold Taylor after a well played first set in the final round. An additional event on the programme was a men's service singles, which was won by H. B. O'Boyle from Alexander Her in the final round, 6/1, 6/3,2/6,6/3. The summaries:

### MEN'S SINGLES.

FIRST ROUND—Alexander Her d. S. A. Beadsley, Jr., 6/1,6/4; J. B. Hughes d. C. C. Groves, 6/3,6/3; Cecil Donaldson d. J. L. Train, 6/3,6/4. SECOND ROUND—Fred Anderson, Jr., d. W. D. Lyon, 6/1,6/4; S. Kashio d. H. C. Brockman, 6/2,6/1; Her d. E. S. Chase, 5/7,6/0,6/4; Fred Anderson d. Ernest Thomas, 6/4,6/4; Ward Dawson d. J. S. O'Boyle, 6/2,2/6,6/2; Donaldson d. J. B. Hughes, 6/3,6/2; R. L. James d. H. V. Owens, 6/2,4/2 (default); Frank Anderson d. Edward Hyland, 6/3,6/1. THIRD ROUND—Fred Anderson, Jr., d. H. B. O'Boyle, 2/6,6/4,6/2; Kashio d. Gerald B. Emerson, 6/1,6/3; Harold Taylor d. G. H. Sicard, 6/2,7/5; Fred Anderson d. Her, 9/7,7/5; Dawson d. Donaldson, 6/1,6/1; T. C. Fulton d. E. F. Torrey, 6/2,6/3; James d. A. C. Acheson, 6/4,6/1; Frank Anderson d. Paul W. Gibbons, 1/6,9/7,6/1. FOURTH ROUND—Kashio d. Fred Anderson, 6/2,1/6,6/4; Fred Anderson d. Taylor, 6/4,6/8,6/3; Dawson d. Fulton, 3/6,6/4,6/3; Frank Anderson d. James, 6/3,6/2. SEMI-FINAL ROUND—Kashio d. Fred Anderson, 6/4,6/8,6/2; Dawson d. Frank Anderson, 4/6,6/3,6/2. FINAL ROUND—S. Kashio d. Ward Dawson, 6/4,6/1,6/1.

CHALLENGE ROUND—Ichiya Kumagae d. Seiichiro Kashio, 4/6,6/3,6/2,9/7.

### MEN'S DOUBLES.

FIRST ROUND—Donaldson and Gibbons d. Groves and Chase, 1/6,6/3,6/4; Fred Anderson and Fred Anderson, Jr., d. Sicard and Torrey, 6/0,7/5; H. B. O'Boyle and Her d. J. S. O'Boyle and Thomas, 6/3,3/6,8/6; Kashio and Emerson d. Train and S. S. Curran, 6/4, 6/3. SECOND ROUND—Irving C. Wright and T. C. Fulton d. Donaldson and Gibbons, 6/3,6/3; H. B. O'Boyle and Her d. Fred Anderson and Fred Anderson, Jr., 6/3,7/5; Kashio and Emerson d. Acheson and Hughes, 6/3,3/6,6/1; Frank Anderson and Harold Taylor d. James and Brookman, 2/6,6/4,7/5. SEMI-FINAL ROUND—Wright and Fulton d. H. B. O'Boyle and Her, 3/6,6/2,6/3; Frank Anderson and Taylor d. Kashio and Emerson, 6/3,6/3. FINAL ROUND—Irving C. Wright and T. C. Fulton d. Frank T. Anderson and Harold Taylor, 6/4,6/2,6/1.

## New York Women's State Championships

The tournament for the New York women's State championships was held as a separate competition in 1918 on the courts of the New York Tennis Club of New York City, beginning September 16. Altogether the events, singles, doubles and mixed doubles, were well played and enjoyable.

Miss Marie Wagner proved to be the class of the singles, and in the final round defeated her opponent, Miss Helene Pollak, without the loss of a set. In partnership with Miss Clare Cassel, Miss Wagner also took the doubles, but not without a hard struggle. In the final round of the mixed doubles, Miss



1, Miss Florence Ballin, New York. 2, Mrs. Barger-Wallach, New York.  
3, Mrs. Rawson Wood, New York.

Eleanor Goss and W. M. Hall defeated Miss Grove and J. H. Steinkampf, 6/4, 7/5. The summaries:

#### WOMEN'S SINGLES.

FIRST ROUND—Miss Bessie Holden d. Mrs. Arthur Duncan, 6,1,6 1; Mrs. S. W. McAneeny d. Mrs. C. C. Parsons, 6/3,6/3; Mrs. L. G. Morris d. Miss Marion Her, 6,1,6/0; Mrs. Percy Wilbourne d. Miss Bessie Wray, 6/0,6 1; Mrs. D. C. Mills d. Mrs. E. H. Thompson, 6/0,6/2; Miss Marie Wagner d. Mrs. J. Smit, 6 0 6 1; Miss Hazel Gardner d. Mrs. William A. Brown, 7/5,6/4; Mrs. Ingo Hartman d. Miss Muriel Binzen, 6/2,6/2; Miss Helene Pollak d. Mrs. E. C. Duble, 6 0 6 2; Mrs. W. H. Pritchard d. Miss Elizabeth McLean, 6/2,6/2; Mrs. S. Waring d. Mrs. F. W. Jenkins, 6/4,7/5; Miss Edith Handy d. Mrs. F. H. Godfrey, 6/3,6/3; Miss Clare Cassel d. Mrs. Albert Humphries, 7/9,6/0,6/1. SECOND ROUND—Miss Holden d. Mrs. McAneeny, 6,1,6 1; Mrs. Wilbourne d. Mrs. Morris by default; Mrs. Mills d. Miss Florence Pond, 6/1,6/2; Miss Wagner d. Miss Gardner, 6/2,6/1; Mrs. Hartman d. Mrs. George B. Stanwix, 6/2,6/2; Miss Pollak d. Miss Caroma Winn, 6/2,6/1; Mrs. S. Waring d. W. H. Pritchard, 6,1,6/3; Miss Handy d. Miss Cassel by default. THIRD ROUND—Miss Holden d. Mrs. Wilbourne, 6,1,6 1; Miss Wagner d. Mrs. Mills, 7/5,6/1; Miss Pollak d. Mrs. Hartman, 6,1,6/3; Miss Handy d. Mrs. Waring, 6/2,6/1. SEMI-FINAL ROUND—Miss Wagner d. Miss Holden, 6 2 6 1; Miss Pollak d. Miss Handy, 2,6,6/2,7/5. FINAL ROUND—Miss Marie Wagner d. Miss Helene Pollak, 6/3,6/1.

#### WOMEN'S DOUBLES.

FIRST ROUND—Mrs. A. Humphries and Miss Holden d. Miss E. White and Mrs. Brown, 6/4,4/6,6/3; Mrs. W. H. Pritchard and Mrs. Mills d. Mrs. Duble and Mrs. Chisholm, 6/2,6/4; Mrs. Waring and Mrs. Wilbourne d. Miss D. Graef and Miss R. Whiteside, 6/2,6/4; Miss Wagner and Miss Cassel d. Mrs. Blum and Mrs. Berolzheimer, 6/3,6/2; Miss Handy and Mrs. Theodore Cassebeer d. Miss Gardner and Mrs. McAneeny, 6,1,6/4. SECOND ROUND—Mrs. H. S. Green and Mrs. Morris d. Mrs. Humphries and Miss Holden, 6/0,6/4; Miss C. Winn and Miss Della Torre d. Mrs. Pritchard and Mrs. Mills, 4/6,6/1, 6/2; Mrs. S. Waring and Mrs. Wilbourne d. Mrs. Hartman and Miss Grove, 6 0 4 6 6 1; Miss Wagner and Miss Cassel d. Miss Handy and Mrs. Cassebeer, 2/6,6/1,6/4. SEMI-FINAL ROUND—Mrs. Green and Mrs. Morris d. Miss Winn and Miss Della Torre, 6/1, 6/3; Miss Wagner and Miss Cassel d. Mrs. Waring and Mrs. Wilbourne, 6/2,6/4. FINAL ROUND—Miss Marie Wagner and Miss C. Cassel d. Mrs. H. S. Green and Mrs. L. G. Morris, 9/7,11/9.

## Eastern New York Championships

The tournament for the Eastern New York championships, held on the four dirt courts of the Mt. Pleasant Tennis Club of Pleasantville, beginning July 13, 1918, was productive of some keen contests. The men's singles went to Fred Anderson, Jr., who defeated Abraham Bassford, Jr., in a well played four-set match. Alexander Her and Henry O'Boyle captured the doubles after a seventy-eight game match with Fred G. and C. A. Anderson.

Miss Marie Wagner was the logical winner of the women's singles and she proved true to form, defeating Miss Edith B. Handy in straight sets. Mrs. Homer Stuart Green and Mrs. L. G. Morris finished in the lead in the doubles, while the mixed doubles went to Miss Marie Wagner and Henry H. Bassford, who won from Miss Edith Handy and William Wadsworth. The summaries:

#### MEN'S SINGLES.

FIRST ROUND—Henry H. Bassford d. J. B. Hughes, 6 2 6 1; Fred Anderson d. Donald Stralem, 6 0 6 3; Philip Brasher d. Trenor Young, 6/2,6/3; Gerald Donaldson, Jr., d. F. W. Osgood, 6/1,6/1; Harold Taylor d. Alexander Her, 6/4,4 6 6 4; T. F. Thomas, Jr., d. Jay Anderson, 1/6,6/4,6/1; W. J. Toussaint d. George S. Groesbeck, 6,1,6/3; A. Bassford, Jr., d. Sigmond Spaeth, 6/1,6/2; Harry Sachs d. P. B. Smith, 5 2 6 2; H. D. Ewing d. E. O. Dorman, 6/3,5/7,8/6; H. B. O'Boyle d. W. A. Bradley, 6/3,6 0; Sgt. John Collom d. Kenneth Ives, 6/2,6/4; H. R. Hathaway d. E. Boy, 6 2 6 3; Gerald Emerson d. H. D. Ewing, 6/1,6/2; William Wadsworth d. Arthur Cave, 6/3,6 2; Fred Anderson, Jr., d. F. T. Osgood, 6/2,6/2; Allen Behr d. A. Bassford, 3d, 6/3,7 9 6 4; W. H. Benedict d. J. S. O'Boyle, 8/3,6/4; W. E. Osgood d. G. A. Walker, Jr., 2 6 6 4,6 6 3; Dr. B. F. Drake d. B. Landau, 6/3,3 6 7 5; W. M. Jennings, Jr., d. S. W. Merrihue, 6 4 6 3. SECOND ROUND—H. H. Bassford d. R. D. Ritchey, 6/8,6/4,6/4; A. D. Hammitt d. K. A. Ives, 6/3,6/3; Fred Anderson d. Frank Danielson, 6/2,6/1; George King d. Brasher, 6/0,6/3; Taylor d. Donaldson, 3/6,6/1,6/4; F. P. Fox d. C. H. Low, 6/1,6/3; Thomas d. Toussaint, 3 6 6 4,6 6 3;

A. Bassford, Jr., d. Sachs, 6/0,6/3; O'Boyle d. Ewing, 6/1,11/9; Collom d. H. R. Hathaway, 6/3,6/1; Emerson d. Anderson, 6/3,6/2; W. E. Houghton, Jr., d. Lindley H. Hill, 4/6,8/6,6/0; Fred Anderson, Jr., d. Wadsworth, 8/6,6/2; Behr d. F. A. Fall, 6/3,6/3; W. E. Osgood d. Benedict, 3/6,6/1,6/1; Drake d. Jennings by default. **THIRD ROUND**—H. Bassford d. Hammill, 4/6,6/4,6/3; Fred Anderson d. King, 6/1,6/3; Taylor d. Fox, 6/4,8/6; A. Bassford, Jr., d. Thomas, 6/0,6/1; Collom d. O'Boyle, 7/5,3/6,6/1; Emerson d. Houghton, 6/2,6/0; Fred Anderson, Jr., d. Behr, 6/2,11/12; Drake d. Osgood, 6/0,6/0. **FOURTH ROUND**—Fred Anderson d. H. Bassford, 6/2,6/4; A. Bassford, Jr., d. Taylor, 6/3,7/5; Collom d. Emerson, 6/0,7/5; Fred Anderson, Jr., d. Drake, 6/0,6/1. **SEMI-FINAL ROUND**—A. Bassford, Jr., d. Fred Anderson, 6/4,6/4; Fred Anderson, Jr., d. Collom, 6/3,2/6,14/12. **FINAL ROUND**—Fred Anderson, Jr., d. A. Bassford, Jr., 7/9,6/4,6/3,6/2.

#### MEN'S DOUBLES.

**FIRST ROUND**—Hughes and King d. Jennings and Brasher, 2/6,6/2,6/1; A. Bassford, Jr., and A. Bassford, 3d, d. Gerald Donaldson and Jay Anderson, 9/7,7/4; Ritchey and Danielson d. J. S. O'Boyle and Thomas, 1/6,6/4,7/5; Sachs and Ives d. Low and Spaeth, 6/1,8/6; H. D. Ewing and J. D. Ewing d. M. A. Horsfall and George K. Guingburg, 6/1, 6/1; Wadsworth and Dorman d. Bradley and Buckout, 6/0,6/3; Taylor and Emerson d. Osgood and Young, 6/1,6/1; Hathaway and Toussaint d. F. W. Osgood and F. T. Osgood, 6/1,6/2; Fred Anderson and C. A. Anderson d. Stralem and Campbell, 6/1,6/1; Houghton and Smith d. Canfield and Merrihew, 6/3,6/1. **SECOND ROUND**—Hughes and King d. Bassford and Bassford, 4/6,6/3,6/3; Her and H. B. O'Boyle d. Ritchey and Danielson, 7/5,5/7,8/6; Groesbeck and Landau d. Sachs and Ives, 7/5,6/3; Wadsworth and Dorman d. Ewing and Ewing, 6/8,6/1,8/6; Walker and Behr d. Taylor and Emerson, 13/11,3/6,11/9; Fred Anderson and C. A. Anderson d. Hathaway and Toussaint, 9/7,6/3. **THIRD ROUND**—Her and O'Boyle d. Hughes and King, 4/6,9/7,6/3; Groesbeck and Landau d. Wadsworth and Dorman, 6/3,4/6,6/4; Fred Anderson and C. A. Anderson d. Walker and Behr, 6/1,6/2; Bassford and Fred Anderson, Jr., d. Drake and Hammitt, 6/4,6/1. **SEMI-FINAL ROUND**—Her and O'Boyle d. Groesbeck and Landau, 6/2,6/0; Fred Anderson and C. A. Anderson d. Bassford and Fred Anderson, Jr., 3/6,6/3,9/7. **FINAL ROUND**—Alexander Her and H. B. O'Boyle d. Fred G. Anderson and C. A. Anderson, 1/6,8/6,16/14,9/11,6/1.

#### WOMEN'S SINGLES.

**FIRST ROUND**—Mrs. Percy Wilbourne d. Miss M. Stralem, 6/0,6/0; Mrs. A. B. Duncan d. Miss Helen Addoms, 6/4,6/1; Mrs. E. V. Lynch d. Mrs. H. J. Ellsworth, 6/0,6/0; Miss Marie Wagner d. Miss Margaret Buckley, 6/1,6/1. **SECOND ROUND**—Mrs. Wilbourne d. Mrs. H. A. Bradbury by default; Miss Edith B. Handy d. Miss Caroma Winn, 6/4,6/1; Miss Bessie Holden d. Mrs. H. H. Bassford, 6/2,6/2; Mrs. Duncan d. Miss Ida Roselle by default; Mrs. D. C. Mills d. Miss C. Bass, 6/3,9/7; Mrs. Lynch d. Mrs. L. G. Morris, 6/1,4/6,6/2; Miss Wagner d. Mrs. W. H. Pritchard, 6/0,6/3. **THIRD ROUND**—Miss Handy d. Mrs. Wilbourne, 7/5,6/3; Miss Holden d. Mrs. Duncan, 6/2,6/2; Mrs. Lynch d. Mrs. Mills, 3/6,6/2,8/6. **SEMI-FINAL ROUND**—Miss Handy d. Miss Holden, 6/3,6/2; Miss Wagner d. Mrs. Lynch, 6/4,6/1. **FINAL ROUND**—Miss Marie Wagner d. Miss Edith B. Handy, 6/2,10/8.

#### WOMEN'S DOUBLES.

**FIRST ROUND**—Mrs. David C. Mills and Mrs. William H. Pritchard d. Mrs. H. H. Bassford and Miss Stralem, 6/1,6/3; Mrs. Homer Stuart Green and Mrs. L. G. Morris d. Mrs. A. Humphries and Miss Holden, 6/2,6/2. **SEMI-FINAL ROUND**—Mrs. Green and Mrs. Morris d. Mrs. H. J. Ellsworth and Mrs. Donatt, 6/1,6/0; Miss Marie Wagner and Miss Caroma Winn d. Miss Edith Handy and Mrs. Edward V. Lynch, 6/2,7/5. **FINAL ROUND**—Mrs. Homer Stuart Green and Mrs. L. G. Morris d. Miss Marie Wagner and Miss Caroma Winn, 6/4,6/1.

**MIXED DOUBLES:** Final Round—Miss Marie Wagner and Henry H. Bassford d. Miss Edith Handy and William Wadsworth, 6/4,6/8,6/3.

## Bronx Singles and Manhattan Doubles

The eighteenth annual tournament of the New York Tennis Club attracted a fine entry and was productive of some really excellent tennis, culminating in a splendidly fought final match, which William T. Tilden, Jr., won from Howard Voshell in the fifth set. The tournament was held on the new club grounds at 238th Street and Broadway and lasted from June 1 to 9.

Tilden reached the final with the loss of but one set, to C. E. Johnson, Jr., in the fifth round. Johnson's aggressive tactics had eliminated Bassford in a close match in the fourth round and he forced Tilden to exert all his skill to

win. Voshell in the other half was gaining much needed practice, and he too dropped only one set, to Elliott Binzen in the semi-final.

Tilden being engaged in Philadelphia on Saturday in the Church Cup contest, the final match was played Sunday, June 9. Both men were on edge and the tide of battle flowed first one way, then the other, through five exciting sets.

Voshell made the most of his service and continually strove for the net, where he gained most of his points. While steadier than Tilden, he lacked the latter's brilliance and variety of strokes, and it was these that proved the deciding factor in the fifth set. However tired Tilden may appear, he seems always to have a burst of speed reserved for the last set, and on this occasion he played at the top of his form, allowing Voshell but two games.

The doubles brought forth another good final round in the match between Binzen and Hartman and Steinkampf and Bassford, four sets being required before the former team won. Steinkampf and Bassford had two difficult matches with Cecil Donaldson and Anderson and Baggs and Voshell, while the Hartman and Binzen combination had dropped a set to Henderson and Stair. In the final, the winners started with a rush, winning two sets with something to spare, but the third went to their opponents, who had steadied and who dropped only the fourth at 5/7. Binzen and Hartman were just a little better, however, and thoroughly deserved their win.

## Long Island Championships

The annual tournament for the Long Island championships, held under the direction of the Kings County Club, Brooklyn, N. Y., beginning June 15, 1918, was successfully conducted and provided an abundance of good play. Frank T. Anderson won the singles, defeating his brother, Fred, in the final round after four well played sets. The doubles went to J. H. Steinkampf, Jr., and H. H. Bassford in a four-set final with A. V. Duncan and H. Morgenthaler. The summaries:

### MEN'S SINGLES.

FIRST ROUND—F. W. Elmendorf d. W. J. Shannon, 6/2,6/1; C. G. Burrows d. J. L. Anderson, 6/0,6/2; Fred Anderson, Jr., d. H. R. Hathaway, 8/10,6/1,8/6; B. W. Stair d. W. H. Ross, 6/4,6/0; H. J. Morgenthaler d. R. D. Ritchey, 8/10,6/3,9/7; H. R. Burroughs d. Vine H. Smith, 6/4,6/3; R. V. Lake d. J. P. Kottcamp, 6/0,9/7; A. R. Platt d. F. O. Freethy, 6/3,4/6,6/4; Cecil Donaldson d. C. C. Pickford, 6/1,6/3; George Copeland d. J. Langworthy, 6/1,4/6,6/2. SECOND ROUND—H. H. Bassford d. S. S. Edmonds, 6/2,6/0; J. S. O'Boyle d. E. F. Thomas, 4/6,6/2,6/1; C. H. Belknap d. E. A. Leflie, 6/2,6/4; A. B. Duncan d. H. B. O'Boyle, 6/2,6/4; S. Kashio d. L. G. White, 6/0,6/0; F. G. Danielson d. W. G. Chinkenbromer, 6/2,6/0; J. B. Hughes d. C. P. Barker, 6/1,6/0; Burrows d. Elmendorf, 1/6,6/0,6/0; Fred Anderson, Jr., d. G. W. Cocks, 6/0,6/0; Morgenthaler d. Stair, 6/4,6/1; F. B. Ogilvie d. Lake, 7/5,5/7,6/4; Frank Anderson d. Platt, 6/3,2/6,6/3; Donaldson d. C. J. Roy, 6/3,5/2; Allen Behr d. Copeland, 6/4,6/4; C. A. Anderson d. Charles Plummer, 6/3,6/1; R. Ives d. L. J. Martin, 6/2,6/3; H. C. Ives d. W. L. Rice, 6/0,6/4; J. E. Cameron d. E. M. Reiner, 6/1,6/1; William Rosenbaum d. W. D. Price, 6/1,6/4; Charles Chambers d. S. D. Ward, 6/4,8/6. THIRD ROUND—Fred Anderson, Jr., d. W. A. Colwell, 6/3,7/5; Harold Taylor d. Bassford, 2/6,10/8,6/3; J. S. O'Boyle d. H. L. Bowman, 6/2,1/6,6/4; Duncan d. Belknap, 6/2,4/6,6/1; Kashio d. R. M. Beach, 6/1,6/2; Danielson d. Hughes, 3/6,6/1,7/5; Morgenthaler d. Burroughs, 6/2,6/2; Frank Anderson d. Ogilvie, 6/4,7/5; Behr d. Donaldson, 6/3,6/3; C. A. Anderson d. Quinn, 6/3,6/1; Ives d. Kirkland, 6/0,6/1; Cameron d. Rice, 6/2,6/2; Chambers d. A. Her, 6/3,6/3. FOURTH ROUND—Taylor d. F. G. Anderson, 7/9,6/3,6/4; Duncan d. J. S. O'Boyle, 6/1,6/1; Kashio d. Danielson, 6/2,6/3; Fred Anderson, Jr., d. Morgenthaler, 6/3,6/1; Frank Anderson d. Behr, 6/0,6/3; Rice d. C. A. Anderson, 7/5,8/6; Cameron d. Ives, 2/6,6/3,6/2; Rosenbaum d. Chambers, 7/5,5/7,7/5. FIFTH ROUND—Duncan d. Taylor, 6/1,6/3; Fred Anderson, Jr., d. Kashio, 7/5,6/4; Frank Anderson d. Rice, 6/0,6/1; Rosenbaum d. Cameron, 6/1,9/7. SEMI-FINAL ROUND—Fred Anderson, Jr., d. Duncan, 6/3,5/7,6/3; Frank Anderson d. Rosenbaum, 6/1,9/7. FINAL ROUND—Frank T. Anderson d. Fred Anderson, Jr., 3/6,6/4,6/4,6/3.

## MEN'S DOUBLES.

FIRST ROUND—Ritchey and Chambers d. H. B. O'Boyle and Hughes, 8/6,7/9,6/3; Davenport and Gatecomb d. Thomas and Her, 6/2,6/4; J. S. O'Boyle and Ward Dawson d. Burrows and Ives, 6/3,6/2; Fred Anderson and H. Mollenhauer d. M. Cohen and S. Cohen, 6/0,6/3. SECOND ROUND—Duncan and Morgenthaler d. J. W. Anderson and Lake, 6/3, 2/6,6/4; Kashio and Behr d. Taylor and Frank Anderson, 3/6,6/3,6/0; Davenport and Gatecomb d. Ritchey and Chambers, 6/2,7/5; Steinkampf and Bassford d. J. S. O'Boyle and Dawson, 3/6,6/3,6/4; Fred Anderson and Mollenhauer d. Price and B. Good, 6/4,6/2; C. A. Anderson and Ross d. Edmonds and J. C. Percy, 6/1,6/4. THIRD ROUND—Duncan and Morgenthaler d. Jennings and Danielson by default; Kashio and Behr d. Davenport and Gatecomb, 6/2,6/4; Steinkampf and Bassford d. Fred Anderson and Mollenhauer, 6/1,6/2; C. A. Anderson and Ross d. Cameron and Cunningham by default. SEMI-FINAL ROUND—Steinkampf and Bassford d. C. A. Anderson and Ross, 6/4,6/1; Duncan and Morgenthaler d. Kashio and Behr, 6/2,6/3. FINAL ROUND—J. H. Steinkampf, Jr., and H. H. Bassford d. A. V. Duncan and H. Morgenthaler, 7/9,6/4,6/4,6/1.

## Brooklyn (N. Y.) Championships

The 1918 tournament for the Brooklyn championships, played at the Terrace Club of Flatbush, attracted a big entry list and was very successful. The singles honor was deservedly won by Charles Chambers, who had a hard road to travel nearly all the way. He faced Ingo Hartman in the final round and had to play four sets to win. The doubles furnished a whirlwind finish. From the manner in which Fred Anderson, Jr., and G. Donaldson, Jr., started off in the final round, it looked like a victory for them. They took the first two sets, but lost the next three and the match owing to the steadiness of their older opponents, J. H. Steinkampf and H. H. Bassford.

## Sullivan County (N. Y.) Championships

B. M. Arnold, Jr., the youngest player who ever reached the final round in the seven years of competition for the Sullivan County championship, defeated B. Landau for the singles title in three straight sets, the first set standing 7/5. By his victory Arnold won his first leg on the Fred B. Alexander Challenge Cup, the previous winners being: 1912-1913, W. C. de Mille; 1914-1915, W. Halsey Wood, and 1916, N. W. Swayne, Jr. There was no contest in 1917 owing to war conditions.

Arnold, paired with J. R. Pitman, Jr., also captured the honors in the doubles in straight sets, but not without a struggle with the Smiths in the final round.

The tournament was ably conducted under the auspices of the Merriewold Tennis Club, but the entry list was much smaller than usual, due no doubt to the enlistment of players into the military or naval forces. The summaries:

## MEN'S SINGLES.

FIRST ROUND—B. Landau d. J. R. Pitman, Jr., 6/1,6/4. SECOND ROUND—B. M. Arnold, Jr., d. Moody, 6/1,6/1; Landau d. F. G. Smith, 6/1,6/4. SEMI-FINAL ROUND—Arnold d. E. J. Shriver, 6/1,6/3; Landau d. Lieut. J. C. Smith, 6/4,6/1. FINAL ROUND—B. M. Arnold, Jr., d. B. Landau, 7/5,6/1,6/3.

## MEN'S DOUBLES.

FIRST ROUND—J. R. Pitman, Jr., and Arnold d. Shriver and E. Moody, 6/1,6/1; Lieut. J. C. Smith and F. G. Smith d. Landau and J. J. Gibbons, 6/4,6/0. FINAL ROUND—J. R. Pitman, Jr., and B. M. Arnold, Jr., d. Lieut. J. C. Smith and F. G. Smith, 6/4,7/5,6/2.

## Great Lakes Championships

Arthur J. Veysey of Montreal, Can., was the dominating figure in the tournament for the championship of the Great Lakes, held on the ten clay courts of the Park Club of Buffalo, beginning July 8, 1918. In the singles, Veysey was

opposed by A. V. Duncan in the final round, and the Los Angeles player put up quite an argument before succumbing. Paired with T. C. Fulton, Veysey added more laurels in the doubles by defeating T. W. Hendrick and Duncan in the final round, but victory came only after five slashing sets. Then in the mixed doubles, Miss Molla Bjurstedt and Veysey defeated Miss McDonald of Toronto and P. V. Bowen of Buffalo in the final round, 6/4,5/7, defaulted.

Miss Bjurstedt won the leading honors among the women players. She defeated Miss Eleonora Sears quite easily in the final round of singles, and paired with Miss Sears, overpowered Miss Best and Miss McDonald in the final round of the doubles, after one of the prettiest matches of the week.

Several exhibition matches were played. R. Lindley Murray was defeated by W. T. Tilden, Jr., 7/5,6/1,6/4, and Miss Bjurstedt and Murray won from Miss Florence Ballin and Tilden, 10/8,6/4. Fulton and Murray defeated Tilden and Veysey, 6/4,6/3. The summaries:

#### MEN'S SINGLES.

FIRST ROUND—T. C. Fulton d. C. Wadsworth, 6/1,6/2; R. W. H. Campbell d. Preston Large, 6/3,3,6,6,0; N. L. Danforth d. E. More, 4-6,6/3,3,6; R. L. Crane d. C. F. Ginther, 6/3,7/5; T. L. Nichols d. E. L. Beebe, 7/5,5,7,6,1; G. W. Minor d. Stoddard, 6,2,6/0; T. W. Hendrick d. D. Bellinger, 6/3,6/0; H. R. Jeffs d. W. G. Flood, 6/4,6/2; G. Ballachey d. C. Parker, 6,2,7/5; A. J. Veysey d. Keneficke, 6,1,6,0; C. W. Pooley d. S. B. Arnold, 6/3,6/2. SECOND ROUND—A. V. Duncan d. L. L. Hanlon, 6,0,6,1; H. C. Wick, Jr., d. K. Hayes, 6/4,3,6,6/4; Fulton d. R. McDonald, 6,2,6,2; Campbell d. L. R. Bissell, 6/3,5/7,6,0; Danforth d. C. R. Whiting, 3,6,6/3,6,2; Crane d. Nichols by default; C. D. Henderson d. E. R. Bartlett, 6/1,6/1; Minor d. P. Brehm, 6,2,6,2; Hendrick d. Jeffs, 7/5,6,1; C. N. Estabrooke d. A. A. Shepard, 6,1,5,7,6,2; R. D. Hausauer d. Ballachey, 6,4,10/8; Veysey d. J. Q. Clarke, 6/1,6/3; W. J. Bott d. R. D. Klinck, 6/1,6/4; Harold Hodge d. Seelbach, 6,0,6,1; Pooley d. P. V. Bowen by default; H. W. Botten d. H. Schultze, 6,2,6,2. THIRD ROUND—Duncan d. Wick, 6,0,7/5; Fulton d. Campbell by default; Danforth d. Crane, 0/1 (defaulted); Henderson d. Minor, 6,1,6,3; Hendrick d. Estabrooke, 6,2,6,2; Veysey d. Hausauer, 6,0,6,3; Hodge d. Bott, 6,2,8,6,6,4; Botten d. Pooley, 6/3,3,6,6,4. FOURTH ROUND—Duncan d. Fulton, 7/5,6,3; Henderson d. Danforth, 6/1,6/0; Veysey d. Hendrick, 3/6,6/4,6,4; Hodge d. Botten, 6,4,6,3. SEMI-FINAL ROUND—Duncan d. Henderson, 6,4,3,6,6,2; Veysey d. Hodge, 6,4,6,0. FINAL ROUND—A. J. Veysey d. A. V. Duncan, 2/6,9/7,7/5,6/2.

CHALLENGE ROUND—A. J. Veysey d. H. V. D. Johns by default.

#### MEN'S DOUBLES.

FIRST ROUND—Ross and Bartlett d. Woods and partner by default. SECOND ROUND—Wick and Botten d. Large and Wadsworth, 6,2,6,3; Ross and Bartlett d. Pooley and Danforth, 12/10,13/11; Hayes and Minor d. Bellinger and Clarke, 6/3,6/3; Henderson and Bowen d. Jeffs and Flood, 6/4,4,6,7/5; Whiting and Bott d. Hausauer and Klinck, 3/6,6/2,6,1. THIRD ROUND—Duncan and Hendrick d. Brehm and Ramsdell, 6,2,6,3; Wick and Botten d. Ross and Bartlett, 6,3,6,2; Henderson and Bowen d. Hayes and Minor, 10,8,6/3; Veysey and Fulton d. Whiting and Bott, 6/1,6,1. SEMI-FINAL ROUND—Duncan and Hendrick d. Wick and Botten, 7/5,6,4; Veysey and Fulton d. Henderson and Bowen, 6/1,6,1. FINAL ROUND—A. J. Veysey and T. C. Fulton d. A. V. Duncan and T. W. Hendrick, 6/1,3/6,7/5,6/8,6/2.

#### WOMEN'S SINGLES.

FIRST ROUND—Miss Pettis d. Miss Feist, 6/4,6/4; Miss Kessel d. Miss Hedstrom, 8/6, 6,2. SECOND ROUND—Miss McDonald d. Miss Brumberg, 6,0,6,1; Miss Best d. Miss Ruby, 6/1,6/0; Miss Molla Bjurstedt d. Miss Bush, 6/1,6/0; Miss Pettis d. Mrs. Schmidt by default; Miss Florence Ballin d. Miss Kessel, 6/1,6,0; Mrs. Henderson d. Miss Knox, 6/3,6/1; Mrs. Burrows d. Miss Williamson, 6/4,6/2; Miss Eleonora Sears d. Miss Van Inwagen, 6/0,6/0. THIRD ROUND—Miss Best d. Miss McDonald, 6,4,6/1; Miss Bjurstedt d. Miss Pettis, 6/1,6/1; Miss Ballin d. Mrs. Henderson, 6/1,6/4; Miss Sears d. Mrs. Burrows, 6/1,6/0. SEMI-FINAL ROUND—Miss Bjurstedt d. Miss Best, 6/0,6/0; Miss Sears d. Miss Ballin, 6/3,6/2. FINAL ROUND—Miss Molla Bjurstedt d. Miss Eleonora Sears, 6/4,6/1.

#### WOMEN'S DOUBLES.

FIRST ROUND—Miss Bjurstedt and Miss Sears d. Mrs. Burrows and Miss Kessel, 6/0, 6/0; Miss Best and Miss McDonald d. Miss Van Inwagen and Miss Pettis, 6/0,6/0. SEMI-FINAL ROUND—Miss Bjurstedt and Miss Sears d. Miss Knox and Miss Hedstrom, 6/2,6/2; Miss Best and Miss McDonald d. Miss Ballin and Mrs. Henderson, 6/4,6/3. FINAL ROUND—Miss Molla Bjurstedt and Miss Eleonora Sears d. Miss Best and Miss McDonald, 6/3,6/4.

## Buffalo City Championships

Lester F. Gilbert, a lieutenant in the Ground Service of the Aviation Corps, again won the singles honors in the tournament for the Buffalo city championships, played on the courts of the Park Club, September 2, 1918, and with H. H. Hodge as a partner, repeated his success of the previous year in the doubles. In the women's singles, Miss Hedstrom, who has the makings of an unusually good player, defeated Mrs. Sloane in the final after the latter had won the first set. The scores were 1/6,3/6,7/5. Mr. Campbell won the consolation singles, defeating Mr. Bott in the final round, 6/2,6/3. Mrs. Gilbert and Lester Gilbert defeated Miss Ruby and Whiting in the final of mixed doubles, 6/1,6/3. The tournament was particularly interesting from the fact that there were so many of the younger players entered and that they advanced so far. The competition was marred by rain.

## New Jersey State Closed Championships

The tournament for the closed championships of New Jersey, played at the Montclair Athletic Club, beginning June 12, 1918, proved a success. There were twenty-five entries in the singles and sixteen pairs in the doubles.

Wallace A. McBurney of Montclair won the lion's share of the honors, defeating R. P. Bennett in the final round of singles in straight sets, and with Otto H. Hinck as a partner took the final round of doubles from R. P. Bennett and I. N. Balch. The summaries:

### MEN'S SINGLES.

FIRST ROUND—H. Oakley d. T. C. Corwin, 6/4,6/2; H. P. Bennett d. Gardner Colby, 3/6,4; L. S. Hobbie d. R. W. Seabury, 6/4,4/6,6/2; L. M. Wood d. Arthur Boyd, 6/4,2; Gerald B. Emerson d. Carl Tucker, 6/2,6/1; Wallace A. McBurney d. Herbert Gardner, 7/5,6/4. SECOND ROUND—Henry Leverich d. E. Flewitt, 8/6,8/6; K. S. Johnson d. G. V. Gilmore, 6/3,6/2; Carl L. Russell d. Oakley, 10/8,7/5; Bennett d. H. R. Widmer, 6/2,4; Wood d. Hobbie, 5/7,6/3,6/2; Emerson d. A. C. Bragaw, 9/7,9/7; Malcolm Scott d. G. V. Hayden, 6/2,4/6,6/3. THIRD ROUND—Leverich d. Johnson, 6/1,6/8,7/5; Bennett d. Russell, 4/6,6/2,6/4; Emerson d. Wood, 6/4,6/1; McBurney d. Scott, 6/0,6/4. SEMI-FINAL ROUND—Bennett d. Leverich, 6/4,6/4; McBurney d. Emerson, 6/2,5/7,6/4. FINAL ROUND—Wallace A. McBurney d. R. P. Bennett, 6/4,6/1,6/3.

### MEN'S DOUBLES.

FIRST ROUND—L. G. French and F. B. Hague d. Anderson and Elendorf, 6/3,5/7,6/1; Seabury and Schenck d. G. F. Hayden and Oakley, 7/5,6/3; Emerson and Imbrie d. Widmer and Scott, 6/2,7/5; Leverich and D. St. C. Moorehead d. Gardner and Russell, 6/4,4; Brown and Wood d. Rutan and Carl Tucker, 6/2,6/3. SECOND ROUND—Seabury and Schenck d. French and Hague, 8/6,3/6,6/4; Bennett and Balch d. Colby and B. Arnold, Jr., 8/6,6/2; O. H. Hinck and McBurney d. Emerson and Imbrie, 7/5,6/1; Brown and Wood d. Leverich and Moorehead, 6/0,6/2. SEMI-FINAL ROUND—Bennett and Balch d. Seabury and Schenck, 6/3,6/3; Hinck and McBurney d. Brown and Wood, 6/2,4. FINAL ROUND—O. H. Hinck and Wallace A. McBurney d. R. P. Bennett and H. B. Balch, 6/2,6/1,6/2.

## New Jersey Women's State Championships

Miss Molla Bjurstedt had no trouble showing her superiority over the players who participated in the tournament for the women's championships of New Jersey, which was decided on the dirt courts of the Orange Lawn Tennis Club, at Mountain Station, during the week of September 30, 1918. She defeated Miss Marion Zinderstein in the final of the singles in straight sets, and with Mrs. S. F. Weaver took the doubles. A mixed doubles event went to Mrs. Homer S. Green and Henry B. O'Boyle, who won from Mrs. Morris and Iler, 2/6,4. The summaries:



## WOMEN'S SINGLES.

FIRST ROUND—Miss Caroma Winn d. Mrs. Mabel D. Straffin, 6/4,7/5; Mrs. S. F. Weaver d. Miss Marion D. Smith, 6/0,6/0; Miss C. Curtis Bass d. Miss May Whaling, 6/0,6/1; Miss Marion Zinderstein d. Mrs. Duble, 6/0,6/0; Mrs. Theodore Cassebeer d. Miss Sheever, 6/1,6/1; Mrs. M. B. Huff d. Miss Madeline Mulqueen, 6/3,6/4; Mrs. D. R. Nichols d. Miss T. M. Scott, 0/6,7/5,6/3; Miss Molla Bjurstedt d. Mrs. S. J. Strauss, 6/0,6/0. SECOND ROUND—Mrs. Weaver d. Miss Winn, 6/0,5/7,6/0; Miss Zinderstein d. Miss Curtis Bass, 6/0,6/3; Mrs. Cassebeer d. Mrs. Huff, 6/1,1/6,6/2; Miss Clare Cassel d. Mrs. Nichols, 6/1,6/4; Miss Bjurstedt d. Miss Helen Boynton, 6/0,6/1; Mrs. Douglas Fonda d. Miss Pond, 6/2,8/6. THIRD ROUND—Mrs. Mills d. Miss Cerese Baker, 6/3,6/2; Miss Zinderstein d. Mrs. Weaver, 6/1,6/4; Miss Cassel d. Mrs. Cassebeer, 6/1,6/2; Miss Bjurstedt d. Mrs. Fonda, 6/1,6/0. SEMI-FINAL ROUND—Miss Zinderstein d. Mrs. Mills, 6/3,6/2; Miss Bjurstedt d. Miss Cassel, 6/1,6/0. FINAL ROUND—Miss Molla Bjurstedt d. Miss Marion Zinderstein, 6/3,6/2.

## WOMEN'S DOUBLES.

FIRST ROUND—Mrs. D. R. Nichols and Mrs. Douglas Fonda d. Miss Madeline Mulqueen and Miss Drake-Smith, 6/4,6/3,6/2; Miss Della Torre and Miss Winn d. Mrs. Duble and Mrs. Chisholm, 6/1,6/3; Miss Handy and Mrs. Mills d. Miss J. M. Gott and Mrs. Mabel Straffin, 6/2,6/3. SECOND ROUND—Mrs. Nichols and Mrs. Fonda d. Miss Clare Cassel and partner by default; Mrs. Weaver and Miss Bjurstedt d. Miss Zinderstein and Miss Goss, 6/3,6/2; Miss Handy and Mrs. Mills d. Miss Della Torre and Miss Winn, 8/6,7/5; Mrs. Green and Mrs. Morris d. Mrs. Cassebeer and Miss Ballin, 6/2,6/4. SEMI-FINAL ROUND—Mrs. Weaver and Miss Bjurstedt d. Mrs. Nichols and Miss Fonda, 6/0,6/1; Mrs. Green and Mrs. Morris d. Miss Handy and Mrs. Mills, 6/1,6/0. FINAL ROUND—Mrs. S. F. Weaver and Miss Molla Bjurstedt d. Mrs. Homer S. Green and Mrs. Morris, 6/2,7/5.

## Pennsylvania State Championships

William T. Tilden, Jr., was the star performer in the tournament for the Pennsylvania State championships, held on the courts of the Merion Cricket Club, Haverford, beginning June 10, 1918. He defeated Dr. P. B. Hawk in the final round of the singles, Tilden's playing being of a brilliant order. He disposed of his veteran opponent in straight sets, two of them at love.

In the doubles, Tilden and his young partner, Carl Fischer, were a bit unsteady in the first two sets of the final round against G. C. Shafer and John C. Bell, Jr., but they steadied down and won the next two sets and match.

The tournament was entirely successful, and there was plenty of excellent play exhibited. The summaries:

## MEN'S SINGLES.

FIRST ROUND—N. W. Swayne d. T. D. Gratz, 7/5,6/2; C. S. Rogers d. C. N. Beard, 6/1,6/3; W. P. Rowland d. H. M. Donovan, 6/1,7/5; R. R. Coffin d. Gilbert Sommer, 6/2,6/3; Dr. P. B. Hawk d. Wallace Rhoads, 6/3,8,6; G. C. Shafer d. W. A. Lippincott, 3d, 6/0,6/1. SECOND ROUND—W. T. Tilden, Jr., d. A. Margolies, 6/0,6/1; J. C. Bell, Jr., d. Albert Batty, 6/4,6/0; C. S. Rogers d. N. W. Swayne, 6/1,6/1; Rowland d. R. R. Coffin by default; G. C. Shafer d. S. J. Hothersall, Jr., 6/1,6/1; Carl Fischer d. E. W. French, 6/2,6/0; H. G. Jones d. Bob McAbee, 6/4,6/2. THIRD ROUND—Tilden d. Bell, 6/4,6/4; Rogers d. Rowland, 6/3,6/2; Hawk d. Shafer, 7/5,6/4; Fischer d. Jones, 6/1,6/4. SEMI-FINAL ROUND—Tilden d. Rogers, 6/3,6/3; Hawk d. Fischer, 6/1,6/1. FINAL ROUND—W. T. Tilden, Jr., d. Dr. P. B. Hawk, 6/2,6,0,6/0.

## MEN'S DOUBLES.

FIRST ROUND—W. H. T. Huhn and H. B. Endicott d. Albert Batty and S. J. Hothersall, Jr., 6/1,6/4; W. T. Tilden, Jr., and Carl Fischer d. Bob McAbee and R. E. Schenck, 7/5,6/1; G. C. Shafer and J. C. Bell, Jr., d. A. Margolies and C. S. Mills, 6/1,6/1. SECOND ROUND—Wallace Rhoads and R. H. Hothersall d. G. C. Hoag and H. J. Cadbury, 6/1,7/5; Tilden and Fischer d. Huhn and Endicott, 6/3,6/4; Shafer and Bell d. W. P. Rowland and A. L. Reed, 6/4,6/2; N. W. Swayne and Dr. P. B. Hawk d. Howard Biddle and partner by default. SEMI-FINAL ROUND—Tilden and Fischer d. Rhoads and Hothersall, 5/7,6/3,6/2; Shafer and Bell d. Swayne and Hawk, 6/3,8/6. FINAL ROUND—W. T. Tilden, Jr., and Carl Fischer d. G. C. Shafer and J. C. Bell, Jr., 7/5,7/9,6/3,6/4.

## Pennsylvania and Eastern States Women's Championships

While the entry list was small and the competition confined almost exclusively to local players, there was much to commend at the tournament for the Pennsylvania and Eastern States women's championships, held on the grass courts of the Merion Cricket Club, Haverford, during the week of June 3, 1918.

Miss Eleonora R. Sears was the class of the singles, her most powerful opponent being Miss M. M. Willard in the semi-final round, which Miss Sears won, 6/3,6/3. She also took the final from Mrs. Fred Betz, 6/0,6/1. Miss G. Ostheimer and Miss E. R. Porter won the doubles from Miss A. B. Townsend and Miss R. G. Thomson in the final after losing the second set.

Miss S. Franklin and W. S. Thomson captured the final of the mixed doubles from Miss M. M. Willard and H. S. Endicott, 6/1,1/6,6/0. Miss A. B. Townsend defeated Mrs. J. E. Bailey in the final of the consolation singles, 6/2,6/2, and Miss S. Franklin and Miss M. Law won the final of the consolation doubles from Mrs. A. Q. Kolff and Mrs. W. K. Yarrow, 6/4,7/9,7/5.

## George Myers Church Cup Competition

The first intercity team competition for the George Myers Church Cup was held on the turf courts of the Merion Cricket Club, Haverford, Pa., June 7 and 8, 1918, the result being an overwhelming victory for the New York team, captained by F. B. Alexander. Boston was defeated on the first day by six matches to three, while the Philadelphia team lost by the same score.

The contest was entirely successful and enjoyable. While each of the cities found it difficult to put a representative team in the field because many of their best players were in the service or unavailable for other reasons, yet a strong contingent turned out for each city. The result was an abundance of good play, and most of the matches were fought with great keenness. The summaries:

### NEW YORK VS. BOSTON.

#### MEN'S SINGLES.

Nathaniel W. Niles (B.) d. Theodore Roosevelt Pell (N.Y.), 5/7,9/7,6/2; Fred B. Alexander (N.Y.) d. Harry C. Johnson (B.), 6/2,6/2; Walter Merrill Hall (N.Y.) d. Irving C. Wright (B.), 6/1,6/3; Lyle E. Mahan (N.Y.) d. R. C. Seaver (B.), 6/1,6/3; Elliott H. Binzen (N.Y.) d. H. H. Bretz (B.), 5/7,6/3,6/4; Raymond D. Little (N.Y.) d. W. H. Abbott (B.), 8/6,4/6,6/4.

#### MEN'S DOUBLES.

H. C. Johnson and G. C. Wright (B.) d. F. B. Alexander and R. D. Little (N.Y.), 6/3,3/6,6/2; W. M. Hall and E. H. Binzen (N.Y.) d. W. H. Abbott and R. C. Seaver (B.), 3/6,7/5,6/3; N. W. Niles and H. H. Bretz (B.) d. L. E. Mahan and T. R. Pell (N.Y.), 6/4,4/6,7/5.

### NEW YORK VS. PHILADELPHIA.

#### MEN'S SINGLES.

William T. Tilden, Jr. (P.) d. Theodore R. Pell (N.Y.), 6/3,6/1; Fred B. Alexander (N.Y.) d. Wallace F. Johnson (P.), 6/0,6/2; Walter Merrill Hall (N.Y.) d. C. S. Rogers (P.), 4/6,6/3,6/2; Elliott H. Binzen (N.Y.) d. Norman W. Swayne (P.), 3/6,6/3,6/3; Lyle E. Mahan (N.Y.) d. Dr. Philip B. Hawk (P.), 6/3,6/3; P. S. Osborne (P.) d. Raymond D. Little (N.Y.), 6/1,6/3.

#### MEN'S DOUBLES.

Alexander and Little (N.Y.) d. Johnson and Swayne (P.), 7/9,7/5,6/1; Tilden and G. C. Shafer (P.) d. Pell and Mahan (N.Y.), 4/6,6/3,6/3; Hall and Binzen (N.Y.) d. Rhoads and Hathersall (P.), 6/4,8/6.

## Philadelphia Roof Court Tournament

A novelty in tennis tournaments was provided by the Philadelphia and District Lawn Tennis Association, when quite a strong field of players participated in a competition on the roof of the John Wanamaker store during the latter part of February and early in March, 1919. The roof contains two courts constructed of boards and covered with canvas. Save for heavy wire netting, making them cages, the courts are open to the elements. All varieties of weather were experienced during the meeting.

Philadelphia was strongly represented in the tournament, the players, headed by William T. Tilden, Jr., including Wallace F. Johnson and Craig Biddle. Among the visitors were Fred B. Alexander, S. Howard Voshell, Ichiya Kumagai, Seichiro Kashio, Vincent Richards and Harold Taylor. Unfortunately Alexander was obliged to default to Tilden in the semi-final round of the singles owing to illness, and with Voshell, his partner, did not appear in the doubles, and Taylor also defaulted to Tilden in the fourth round of singles.

The final of the singles attracted the largest gallery and brought out the most sensational playing of the tournament. Tilden and Richards were the contestants. Owing to rain, the courts were very slippery at the start. Richards by clever placing and accurate volleying took the first set, 6/4. The second set was Tilden's from the start, 6/3. Richards won the third set, 7/5, but from there on Tilden rushed matters and won the fourth and fifth sets and the match, 6/2,7/5. In the doubles, Wallace Johnson and Craig Biddle looked like winners in the earlier portion of the final, taking the first set, 8/6, and leading in the second, 6/5. At this stage Tilden and Richards braced up and won three straight sets and the match, 8/6,6/1,6/3.

## Central Pennsylvania Championships

The championships of Central Pennsylvania were held at the Altoona Cricket Club, Altoona, Pa., August 27 to 30, 1918. Red Cross bronze medals in the form of watch fobs were given to the winners and the balance of the proceeds were donated to the Red Cross. In the singles, Arthur M. George of Lancaster defended his title successfully against L. I. Replogle, winning in straight sets; while in the doubles, George and F. L. Windolph proved superior to G. A. Kerbaugh and C. F. King, Jr., both of Altoona. The summaries:

### MEN'S SINGLES.

FIRST ROUND—L. I. Replogle d. J. M. Fay, 6/3,8/6; C. G. Hauser d. C. F. King, Jr., 8/6,6/3. SECOND ROUND—J. P. Neff d. E. Fay, 6/4,6/0; Replogle d. J. E. Booth, 6/0, 6/1; C. G. Hauser d. G. Banados, 6/1,7/9,6/2; G. A. Kerbaugh d. F. Santa Cruz, 6/2,6/1. SEMI-FINAL ROUND—Replogle d. Neff, 6/0,6/2; Hauser d. Kerbaugh, 7,5,3,6,6/4. FINAL ROUND—L. I. Replogle d. C. G. Hauser, 6/1,6/2,6/2.

CHALLENGE ROUND—Arthur M. George d. L. I. Replogle, 6/0,6/3,6/1.

### MEN'S DOUBLES.

SEMI-FINAL ROUND—E. Fay and C. G. Hauser d. F. Santa Cruz and G. Banados, 6/1,6/2; G. A. Kerbaugh and C. F. King, Jr., d. L. I. Replogle and J. M. Fay by default. FINAL ROUND—G. A. Kerbaugh and C. F. King, Jr., d. E. Fay and C. G. Hauser, 6/2,6/2,6/4.

CHALLENGE ROUND—F. Lyman Windolph and Arthur M. George d. G. A. Kerbaugh and C. F. King, Jr., 6/0,6/1,6/1.

## Western Pennsylvania Championships

With an entry list of unusually high class and a fine assortment of tennis throughout, the tournament for the Western Pennsylvania championships, held on the courts of the Pittsburgh Athletic Association during the week of June 22, 1918, was one of the most successful of the year. W. T. Tilden, Jr., of Philadelphia garnered the honors in the men's singles by defeating Charles S. Garland in a well fought four-set match. The final round of the doubles developed into one of the best matches ever played on the courts. The winners were Samuel Hardy and C. S. Garland, who defeated Tilden and P. D. Siverd after five thrilling sets.

Miss Molla Bjurstedt and Mrs. George W. Wightman were the finalists in the women's singles, and while Miss Bjurstedt was returned the winner, the match was much closer than the score would indicate. A number of unusually strong teams appeared in the mixed doubles, the event narrowing down to a vigorous two-set match between Mrs. G. W. Wightman and C. S. Garland and Miss Bjurstedt and W. S. McElroy. The former pair won, 8/6,6/2. The summaries:

### MEN'S SINGLES.

FIRST ROUND—T. W. Stephens d. J. B. Burnside, 6/4,4/6,6/2; G. B. Moreland d. F. A. Crabtree, 3/6,6/2,6/2; A. Bialas d. H. K. Oehmeler, 6/1,6/3; Col. J. C. W. Brooks d. C. J. Code, 6/4,6/2; F. E. Schuchman d. H. L. Kelth, 6/0,6/0; W. J. Bird d. T. M. Marshall, 7/5,6/4; W. T. Tilden, Jr., d. J. W. Carach, 6/0,6/1; R. J. Moore d. T. C. McGowan, 6/1,4/6,6/3; J. H. Meredith d. L. J. Lease, 6/0,6/1; D. W. Lloyd d. M. W. Bovard, 6/1,6/1; W. B. Canfield d. Leonard Reed, 6/1,6/3; Grant Siverd d. Charles Garland, 6/0,6/1; F. A. Galer d. Alan A. Garland, 6/0,6/1; W. S. McElroy d. W. W. Dermitt, 6/4,6/1. SECOND ROUND—Stephens d. Joseph Josack, 6/1,6/1; W. A. Higgins d. Moreland, 3/6,6/2,6/2; C. S. Garland d. Bialas, 6/0,6/0; Brooks d. Schuchman, 7/5,6/3; E. Sunstein d. Bird, 6/0,6/1; Tilden d. J. M. Stewart, 6/2,6/1; Moore d. Meredith, 6/4,6/1; Lloyd d. J. B. Cummings by default; Siverd d. Canfield, 1/6,6/0,6/0; Herbert Patterson d. Galer, 6/3,6/2; McElroy d. J. H. Bialas, 6/3,6/2; R. D. Campbell d. H. M. Keller, 6/3,6/4. THIRD ROUND—Sam Hardy d. T. C. Ward, 6/2,6/1; Stephens d. H. E. Anderson by default; Garland d. W. A. Higgins, 6/0,6/0; Sunstein d. Brooks, 6/0,6/0; Lloyd d. Siverd, 6/0,6/1; McElroy d. Patterson, 3/6,6/2,6/1; E. Binzen d. Campbell by default. FOURTH ROUND—Hardy d. Stephens, 6/3,6/4; Garland d. Sunstein, 6/2,6/2; Tilden d. Lloyd, 6/2,7/5; Binzen d. McElroy, 6/1,6/3. SEMI-FINAL ROUND—Garland d. Hardy, 10/8,6/3; Tilden d. Binzen, 6/2,6/4. FINAL ROUND—W. T. Tilden, Jr., d. C. S. Garland, 2/6,6/3,7/5,6/3.

### MEN'S DOUBLES.

FIRST ROUND—G. Siverd and Binzen d. Ward and Bialas, 6/3,7/5; Col. Brooks and Schuchman d. Charles Garland and A. A. Garland, 1/6,6/4,6/3. SECOND ROUND—Lloyd and Sunstein d. Code and Lane, 6/0,6/0; Hardy and C. S. Garland d. Campbell and Patterson, 6/0,6/2; G. Siverd and Binzen d. Burnside and Tritsch, 6/1,6/2; Brooks and Schuchman d. Pyle and Hughes by default; Stephens and McElroy d. Stewart and Dannals, 6/1,6/2; Moore and P. H. Stephens d. Meredith and Seymour, 7/5,6/8,6/4. THIRD ROUND—Hardy and Garland d. Lloyd and Sunstein, 6/1,6/2; G. Siverd and Binzen d. Higgins and Thompson by default; Tilden and P. D. Siverd d. Brooks and Schuchman, 6/2,6/3; Stephens and McElroy d. Moore and P. H. Stephens, 6/3,6/4. SEMI-FINAL ROUND—Hardy and Garland d. G. Siverd and Binzen, 6/0,6/2; Tilden and P. D. Siverd d. Stephens and McElroy, 6/1,5/7,6/1. FINAL ROUND—Samuel Hardy and C. S. Garland d. W. T. Tilden, Jr., and P. D. Siverd, 6/4,6/1,5/7,4/6,6/4.

### WOMEN'S SINGLES.

FIRST ROUND—Miss Molla Bjurstedt d. Miss Hoffman, 6/1,6/0. SECOND ROUND—Mrs. G. W. Wightman d. Miss E. Stephenson, 6/0,6/0; Miss M. Campbell d. Miss M. Beeson, 6/2,6/1; Miss Florence Ballin d. Miss Grace Densus, 6/1,6/0; Miss Mabel Miller d. Miss Campbell, 6/1,6/2; Miss Bjurstedt d. Miss B. Garrison by default; Miss E. Brainerd d. Miss F. Allison, 6/1,6/0; Miss Marion Zinderstein d. Miss E. Laurie, 6/0,6/1. THIRD ROUND—Mrs. Wightman d. Miss M. Campbell, 6/0,6/0; Miss Miller d. Miss Ballin, 6/1,6/2; Miss Bjurstedt d. Miss Brainerd, 6/1,6/1; Miss Zinderstein d. Miss E. Jones by default. SEMI-FINAL ROUND—Mrs. Wightman d. Miss Miller, 6/2,6/1; Miss Bjurstedt d. Miss Zinderstein, 6/2,6/3. FINAL ROUND—Miss Molla Bjurstedt d. Mrs. George W. Wightman, 5/7,6/3,6/3.

**Ardley Club's Women's Invitation Tournament.**—With a large entry list, excellent play in all the events and the grass courts in prime condition, the annual women's invitation tournament of the Ardley Club, Ardley-on-Hudson, N. Y., beginning June 4, 1918, was a complete success. The final round of singles brought Miss Molla Bjurstedt and Mrs. H. S. Green together, but after winning the first set, 6/4, Mrs. Green found the pace was too fast and Miss Bjurstedt scored an easy victory, 6/1,6/2. In the doubles, Miss Bjurstedt and Mrs. Rogge were eliminated in the third round by Mrs. Green and Mrs. A. F. Thurber, who finally won the event, defeating Miss Natalie Browning and Mrs. Dickinson, 7/5,6/3. The mixed doubles went to Mr. and Mrs. Thurber, who disposed of Mrs. W. H. Pritchard and Herbert I. Foster in the final round, 6/2,6/1.

**Heights Casino Women's Invitation Tournament, 1919.**—In a competition admirably conducted and replete with brilliant playing, Miss Molla Bjurstedt won the singles in the annual women's invitation tournament of the Heights Casino, Brooklyn, N. Y., during the week of February 3. The matches were decided on two canvas-covered courts, and altogether it was a successful and enjoyable affair. With the exception of Miss Eleonora Sears of Boston, the entry list was confined to players in and around New York. Miss Bjurstedt's opponent in the final round was Miss Marie Wagner, and although won in straight sets by the former, it was a good match, the score being 6/2,6/4. The final was an interesting match with surprising results. By faultless team work, Miss Wagner and Miss Clase Cassel defeated Miss Bjurstedt and Miss Eleonora Sears, 6/4,6/4, in the final.

**Husbands and Wives Tournament.**—The initial husbands and wives tournament, held by the New York Tennis Club, beginning June 30, 1918, attracted an entry list of sixteen pairs, and altogether the competition was entirely successful. The final round brought together Mr. and Mrs. E. W. Raymond against Mr. and Mrs. Ingo Hartman and the result was a close and hard fought battle. Fine passing shots by Mrs. Raymond and the steady and dependable playing of Raymond enabled them to win, 7/5,6/8,6/4.

**Kings County Tennis Club Championship.**—Channing G. Burrows is the new champion of the Kings County Tennis Club of Brooklyn. He won the title in the tournament last fall, defeating R. M. Beach in the semi-final round, 6/1,6/4, and then winning from Fred Anderson, Jr., in the final after four well played sets, 5/7,6/4,6/3,6/3. Dr. H. J. Morgenstaler was to have met Anderson in the semi-final, but had to default owing to illness.

**Lake George (N. Y.) Championships.**—The annual championships of Lake George were resumed at the Lake George Club, Diamond Point-on-Lake George, August 19-21, 1918. Although the entry list was small, play throughout was interesting. R. L. James of Saratoga repeated his victory of 1916 by defeating E. S. Chase in the final round of the singles, 6/4,6/4,6/2. These two players won the doubles, defeating Bennett and White in the final, 6/4,6/2,6/1. Miss Elizabeth McConaughy carried off the honors in the women's singles, winning the first set from Miss R. Hermann, 6/1, the latter defaulting the second. Miss Simpson and E. S. Chase were too much for Miss McConaughy and R. L. James in the final round of the mixed doubles, the score being 6/2,6/2.

**Nassau Country Club Invitation Doubles Tournament.**—The 1918 invitation tournament of the Nassau Country Club at Glen Cove, L. I., N. Y., was confined to one day's play, July 4, and only to doubles. War conditions compelled the abandonment of three days' play. Five teams were engaged in the fray, Beals C. Wright and Raymond D. Little winning the final round from Walter M. Hall and H. C. Martin, 6/4,6/4. It was an excellent match, Wright's playing being especially good. In the first round, G. A. L. Dionne and Charles Chambers won from William Rosenbaum and W. L. Pate, 6/4,7/9,6/4, and in the semi-final, Wright and Little won from Dionne and Chambers, 6/3,6/4, and Hall and Martin outplayed Lyle E. Mahan and F. C. Baggs, 6/3,6/4.

**Westchester County (N. Y.) Lawn Tennis Association Championships.**—Spirited play and a successful tournament marked the annual championships of the Westchester County (N. Y.) Lawn Tennis Association, held at the Gedney Farm Country Club during the week of June 22, 1918. The men's singles went to George King after a stubbornly contested final round with Abraham Bassford, Jr., 6/8,6/2,6/2,8/6, and the doubles event was taken by the Bassfords, A. Jr. and A. 3d, who defeated E. Thomas and J. S. O'Boyle in the final, 6/4,9/7,6/8,6/8,6/3. Miss Helen Gillendeau proved the strongest in the women's singles, winning from Miss Madeline Lowerre in the final round, 6/2,6/2. Miss Gillendeau, paired with A. Bassford, Jr., also annexed the mixed doubles, overpowering Miss Lowerre and J. S. O'Boyle, 6/3,8/6.

**University Heights Tennis Club Tournament.**—Following up his victory in the Long Island championship, Frank T. Anderson, the Brooklyn youngster, captured the North Side title at the tournament of the University Heights Tennis Club, New York City, beginning June 29. He faced W. H. Benedict in the final round and never was in danger in the three sets played. The scores were 6/1,6/4,6/0. There was good competition in the doubles, the winners turning up in Benjamin Letson and Fred Anderson, Jr. This pair defeated W. H. Benedict and E. M. Randall, 6/1,6/0,6/4.

**Utica City (N. Y.) Championships.**—In a tournament for the Utica city championships, held on the courts of the Yahmudasis Golf Club, George H. Sicard, formerly of Buffalo, won the singles, defeating J. L. Train in the final round after five hard sets, 6/1, 4/6,8/10,12/10,6/2. Sicard with Edwin F. Torrey as a partner also captured the doubles from Guile and Harold Semple, 6/1,6/8,6/3,6/3.

**Lake Erie Tennis League Tournament.**—Intercity matches between Buffalo, Cleveland, Detroit and Toledo for the Lake Erie League Cup made up the tournament of the Lake Erie Tennis League, held at the Park Club of Buffalo. By winning the event Buffalo got on even terms with Cleveland, each having two legs on the cup, Toledo and Detroit having one each. The matches were all close, Buffalo defeating Detroit the first day, five matches to four, and Cleveland defeating Toledo by the same score. In the finals, Buffalo won from Cleveland, five matches to four.

**Atlantic City (N. J.) Championship.**—T. M. Harris, Jr., of Wilmington, Del., and Forest E. Adams of Chicago had quite a tussle for the Atlantic City championship, which was decided on the courts of the Atlantic City Yacht Club during the week of July 29, 1918. Adams took the first set, 4/6, but Harris annexed the next three and the title, 6/4,6/4,6/4.

**Central New Jersey Championships.**—The Engleside Tennis Club, Beach Haven, held the Central New Jersey championships on its dirt courts, July 20 to 27, 1918. The competition was not a great success owing to the small entry and to the interference of play for three days by rain, postponing the finals. The best matches of the tournament came in the three finals, all of which were hotly contested. Eugene A. Leinroth won the men's singles, defeating Morton Gibbons-Neff, 4/6,6/3,6/4,6/3, while Morton Gibbons-Neff and Phillip Lueders were successful in the doubles, defeating Watson and Teneick, 2/6,6/8,8/6,6/0,6/2. The women's singles was won by Miss Katherine Porter, who defeated Mrs. William T. Galey, Jr., in a close three-set match in the final round, 6/1,5/7,6/4.

**New Jersey Coast Championship.**—After a hair-raising contest of five sets in the final round, J. P. Stockton defeated C. N. Durrie and became champion of the New Jersey Coast. The competition was played on the courts of the Bay Head Yacht Club at Bay Head, and after the first two sets of the final, which he won, Durrie looked all over a winner. Stockton, however, braced up amazingly and took the next three sets and the match. The scores were 5/7,2/6,6/0,6/1,6/2.

**North Jersey Coast Championships.**—J. P. Stockton of Spring Lake won the championship of the North Jersey Coast in singles, at the tournament held on the dirt courts of the Bathing and Tennis Club, Spring Lake, during the week of July 18, 1918. He triumphed over J. H. Dodd in the final round, 6/1,6/3, and then met Lindsay Dunham of Elizabeth, the 1916 champion, in the challenge round. In this match Stockton encountered stiff opposition and won only after four sets had been played, 6/2,6/4,4/6,30/8. The doubles went to Otto H. Hinck and Frank B. Hague, who won from W. H. Benedict and Edward Randall, 6/2,12/10,6/1.

**Eagles Mere (Pa.) Championships.**—The annual championships, held under the auspices of the Eagles Mere Athletic Association, were resumed during the week of August 26, 1918, with satisfactory results. The match for the singles title developed into a stubbornly fought contest between J. Morris Wister of Philadelphia and John C. Bell, Jr., of the same city. Wister won after four sets, 2/6,8/6,6/4,6/4, and with the victory permanently went the Crestmont Inn Challenge Cup, being his third win for the trophy. Jarvis and Dickson of Pittsburgh and Berwick, respectively, took the doubles from Bell and H. B. Endicott in the final round, 3/6,6/2,2/6,6/4,6/4. Mrs. Broekhaven of East Orange, N. J., won the women's singles in the final from Miss MacGowan, 3/6,6/2,6/4, and was also successful in the mixed doubles, paired with W. H. Thomas, Jr., of Wilmington, Del.

**Westmoreland County (Pa.) Championships.**—The tournament for the championship of Westmoreland County, under the auspices of the Jeannette Tennis Association, Jeannette, Pa., resulted in some interesting matches and a number of surprises. In the singles James Hughes won the final round by defeating F. A. Galer, 6/0,6/1,6/4, but in the challenge round Paul Euwer was triumphant, Hughes defaulting after each had won a set. Galer and Ashcone took the final of the doubles, but Hughes and Baughman won the challenge round, 6/2,6/3,6/4. Miss Hill won the honors in the women's singles, and with H. Garman as a partner annexed the mixed doubles, 4/6,6/4,7/5. In the challenge round Miss Wilson and Euwer defaulted.

**South Jersey Championships.**—Dr. Philip B. Hawk of Philadelphia is now South Jersey champion, having won that distinction in the tournament held on the courts of the Ocean City Yacht Club, August 17 to 24, 1918. As it was a play through competition, Harvey Y. Lake, the previous champion, was absent and was obliged to default. Dr. Hawk defeated Arthur L. Reed in the final round of singles, 7/5,6/3,6/1. In the doubles, Paul W. Gibbons and Arthur L. Reed defeated Hawk and Adams the best two out of three sets, 6/3,4/6,6/2. Mrs. S. Fullerton Weaver of New York won the women's singles, her opponent in the final round being Mrs. Robert Herold. The scores were 8/6,6/0. Mrs. Cary Potter and Mrs. C. R. Wainwright disposed of Mrs. Herold and Mrs. J. D. Strebig in the final round of doubles, 3/6,6/1,6/2. Mrs. Strebig and Paul W. Gibbons outplayed Mrs. Herold and Arthur Reed in the final round of mixed doubles, 6/1,6/1.

# Tri-State Tournaments

## Ohio State Championships

War conditions did not seem to affect the twenty-second annual tournament for the championships of Ohio, held at the East End Tennis Club of Cleveland, beginning August 17, 1918. In fact, it was one of the most successful in the history of the event.

Samuel Hardy of Chicago, as in 1917, won the singles, but the final round had an unfortunate ending. Walter Westbrook, Hardy's opponent, led at two sets to one, when illness compelled him to default in the fifth set. What was considered the surprise of the tournament was the defeat of A. J. Veysey of Montreal, winner of the Great Lakes championship, by Dr. W. H. Thwaites of Grand Rapids, Mich., in the second round. In the doubles, Westbrook and Vinton Vernon were winners in the final, after losing the second set, 10/12.

The play in the women's events was interesting. Miss Ruth Wise defeated Miss Buda Stephens in the final of the singles, while Miss Estelle Corday and Miss Stephens won from Mrs. Cobb and Mrs. Peters in the final of the doubles. The summaries:

### MEN'S SINGLES.

FIRST ROUND—Jack Rice d. A. D. Fuldheim, 2/6,6/2,7/5; F. H. Hobson d. N. C. Newcomb, 6/1,6/2; Carl Raseman d. John Crafts, 6/4,6/3; H. W. Botten d. Jim Marshall, 4/6, 6/4,6/4; H. C. Wick, Jr., d. W. E. Conley, 6/4,6/3; F. T. Fauntleroy d. J. F. Bauder, 6/4,6/3; Vinton Vernon d. Jim Sands, 6/4,6/2; Paul Kroehle d. Ashley VanDuzer, 4/6, 6/3,8/6; N. C. Holes d. A. D. Schwengler, 5/7,6/3,6/2; Harold Bartel d. F. W. Wagner, 6/0,6/2; Dr. Thwaites d. Frank Hawk, 6/1,6/1; P. V. Bowen d. C. B. Gibson, 6/0,6/1; Ben Thorward d. Alex. Nason, 6/3,6/3; Don White d. E. W. Sisson, 6/2,6/1; W. A. Bridgeman d. H. W. Hane, 0/6,6/4,6/4; L. E. Munz d. F. M. Slough, 6/0,6/1; Gordon Minor d. F. L. Archer, 6/0,6/2; H. H. Hodge d. Paul Voorheis, 6/2,6/0. SECOND ROUND—Rice d. Hobson, 6/0,6/3; Raseman d. Botten, 6/3,10,8; Wick d. Fauntleroy, 6/4,6/0; Spaulding d. Adams, 4,6,6/3,6/4; Vernon d. Carran, 6/1,7/5; Samuel Hardy d. Kroehle, 6/3,6/3; Holmes d. King, 6/3,6/3; Bartel d. Abbey, 6/0,4,6,6/2; Dr. Thwaites d. A. J. Veysey, 4/6,7/5,8/6; S. Manchester d. G. Thorward, 7/5,6/1; Kirk Reid d. Charles Whiting, 6/3,8/6; Bowen d. Ben Thorward, 6/1,6-1; Walter Westbrook d. White, 6,3,6/2; Bridgeman d. Munz, 7/5,6/3; Minor d. Eidelman, 6/2,6/4; Hodge d. Mitchell, 6/2,6/2. THIRD ROUND—Raseman d. Rice, 1/6,6/4,6/4; Wick d. Spaulding, 6/2,6/3; Hardy d. Vernon, 6/1,6/2; Bartel d. Holmes, 6/3,1/6,6/2; Dr. Thwaites d. Manchester, 6/4,2/6,6/3; Reid d. Bowen, 6/1,6/4; Westbrook d. Bridgeman, 6/1,6/3; Hodge d. Minor, 6,2,6/4. FOURTH ROUND—Wick d. Raseman, 2/6,8,6,6/2; Hardy d. Bartel, 6/4,6/1; Reid d. Dr. Thwaites, 6/4,2/6,6/3; Westbrook d. Hodge, 6,1,7-5. SEMI-FINAL ROUND—Hardy d. Wick, 7/5,6/4,8/6; Westbrook d. Reid, 6,0,6/3,2,6,6/2. FINAL ROUND—Samuel Hardy d. Walter Westbrook, 4,6,6/1,7/9,6/0,3/0 (default).

### MEN'S DOUBLES.

FIRST ROUND—Veysey and Whiting d. Lang and Buckley, 6/1,7/5; Reid and Marshall d. Thorward and Thorward, 6/3,6/3; Crafts and Voorheis d. Fuldheim and White, 4/6, 8/6,6/2; Westbrook and Vernon d. Nason and Manchester, 6/0,6/2; Reese and McConaughy d. Dr. Thwaites and Raseman, 5/7,6/1,6/3; Cabell and Botten d. Fisher and Ellwood, 6/1,6/2; Wick and Carran d. Handy and Chopp, 6/1,6/0; Bowen and Hodge d. Mueller and Mueller, 6/2,4,6/11/9. SECOND ROUND—Reid and Marshall d. Veysey and Whiting, 6/1,7/5; Westbrook and Vernon d. Crafts and Voorheis, 7/5,6/0; Minor and Minor d. Munz and Fauntleroy, 6/0,6/4; Kroehle and Dibble d. Sands and Rice, 6/1,6/2; Reese and McConaughy d. Cabell and Botten, 7/5,6/4; Bowen and Hodge d. Wick and Carran, 6/2, 7/5. THIRD ROUND—Westbrook and Vernon d. Reid and Marshall, 6/0,6/4; Hardy and Abbey d. Minor and Minor, 6/1,6/3; Hane and Bartel d. Kroehle and Dibble, 6/3,6/3; Bowen and Hodge d. Reese and McConaughy, 6/3,6/4. SEMI-FINAL ROUND—Westbrook and Vernon d. Hardy and Abbey, 6/4,6/3,2-6,3/2 (default); Hane and Bartel d. Bowen and Hodge, 4,6,6/3,6/3. FINAL ROUND—Walter Westbrook and Vinton Vernon d. H. W. Hane and Harold Bartel, 6,2,10/12,6/2,6/1.

### WOMEN'S SINGLES.

FIRST ROUND—Miss Mildred Rask d. Miss Ruth Mahler, 6/1,7/5; Miss Buda Stephens d. Miss Helen Zahn, 6/4,6/0; Miss Barbara Killey d. Mrs. Cobb, 8/6,6/4; Mrs. Peters d.

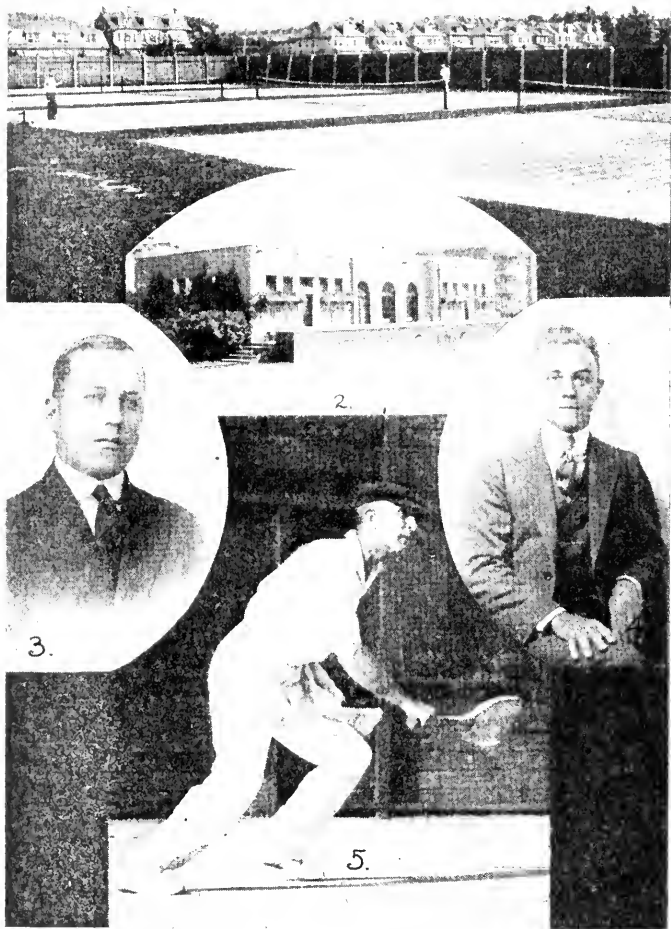

1. Bethlehem Steel Company's Tennis Courts at Bethlehem, Pa. 2. Clubhouse of Detroit Tennis Club, Detroit, Mich. 3. B. F. Thorward, President Cleveland Associated Tennis Clubs. 4. H. C. Wick, Jr., Vice-President Cleveland Associated Tennis Clubs. 5. S. W. Cabell, Cleveland City Champion.



Miss Irene Esch, 6/2,4/6,6/1; Miss Ruth Wise d. Miss Estelle Corday, 7/5,7/5; Miss Bobbie Esch d. Miss Anna Wolf, 6/1,6/2. SECOND ROUND—Miss Stephens d. Miss Rask, 6/3,6/1; Miss Mock d. Miss Killey, 12/10,6/1; Miss Wise d. Mrs. Peters, 6/4,6/4; Miss Esch d. Mrs. Bentley, 6/1,6/2. SEMI-FINAL ROUND—Miss Stephens d. Miss Mock, 6/1,6/3; Miss Wise d. Miss Esch, 7/5,6/2. FINAL ROUND—Miss Ruth Wise d. Miss Buda Stephens, 6/0,6/4.

#### WOMEN'S DOUBLES.

FIRST ROUND—Miss Estelle Corday and Miss Buda Stephens d. Miss Helen Sprague and Miss Elizabeth Mock, 6/4,6/4; Miss Bobbie Esch and Miss Irene Esch d. Miss Mildred Rask and Miss Barbara Killey, 6/4,6/2; Mrs. Cobb and Mrs. Peters d. Mrs. Bentley and Miss Helen Zahn, 2/6,6/1,9/7; Miss Ruth Wise and Miss Ruth Mahler d. Miss Edith Esch and Miss Genevieve McNulty, 6/4,6/2. SEMI-FINAL ROUND—Miss Corday and Miss Stephens d. Miss B. Esch and Miss I. Esch, 6/1,6/3; Mrs. Peters and Mrs. Cobb d. Miss Wise and Miss Mahler, 5/7,8/6,10/8. FINAL ROUND—Miss Estelle Corday and Miss Buda Stephens d. Mrs. Cobb and Mrs. Peters, 3/6,6/2,6/3.

## Cleveland Associated Tennis Clubs

BY B. F. THORWARD, PRESIDENT.

The second season of tennis in Cleveland, under the direction of the Cleveland Associated Tennis Clubs, proved far more successful than any former year of tennis, although many of the local stars were missed, having gone into war service. Due to the splendid co-operation given the association by the member clubs, the tennis interest increased among the junior players, and, since most of the tournaments were played after 5 p. m., the entry lists for all tournaments were larger than in former years. The tournaments played under the auspices of the C.A.T.C. were: City championship, men's and women's; Cleveland District junior championship, boys' and girls'; Ohio State championship, and the "Red Cross Rapid Fire" tournament.

The Interclub Tennis League, in which the East End Tennis Club won by the closest possible margin from the University Club, proved an interesting race throughout the season and kept tennis activities constantly alive. Following is the final standing of the league:

| Team.                     | Won. | Lost. | P.O. | Team.                      | Won. | Lost. | P.O. |
|---------------------------|------|-------|------|----------------------------|------|-------|------|
| East End Tennis Club..... | 51   | 12    | .809 | Cleveland Heights T.C..... | 19   | 35    | .352 |
| University Club .....     | 57   | 15    | .792 | Cleveland Yacht Club.....  | 8    | 19    | .297 |
| Nela Park .....           | 40   | 23    | .635 | Colonial East Shore Club.  | 15   | 39    | .277 |
| Cleveland Tennis Club.... | 38   | 25    | .603 | National Carbon .....      | 3    | 51    | .056 |
| West Shore Tennis Club..  | 30   | 42    | .417 |                            |      |       |      |

The closing match of the year between University Club and East End Tennis Club proved a most thrilling wind-up, University winning, 6 to 3, but lacking one match of winning the championship. Nela Park earlier in the season defeated University Club, 5 to 4, which was the upset that cost the latter club the pennant. Charles Carran of the West Shore Club, former Western Conference intercollegiate champion; Vinton Vernon of Nela Park Club, doubles champion of Michigan State and Ohio State, and H. C. Wick, Jr., of University Club, were the individual stars in the year's intercollegiate matches.

The Cleveland Associated Tennis Clubs officially closed their season on September 28 with a "Red Cross Rapid Fire" tournament, which is believed to be the largest ever played in one afternoon. It was held on the courts of the three largest Cleveland clubs—University, East End and Nela Park. Each of the eight clubs entered twelve men, ninety-six players in all, and these men were drawn for play in the usual manner, although it was arranged so that no two men of the same team played each other in the first two rounds. Each

match was only one set, the winner scoring points for his team. The first round counted one point, the second round two points, and so on up to the final. Any player losing in the first round went into the consolations, where he could score points for his team. This kept all the players interested throughout.

The players were conveyed in automobiles to the University Club for the semi-finals and final. Harold Bartel, holder of the municipal championship in singles and doubles, and city doubles and mixed doubles championship, won the tournament and the Red Cross medal by defeating George Thorward in the final, 6/2. On the way to the final Bartel met and defeated Charles Carran, 6/2, and H. C. Wick, Jr., 8/6. East Shore Club won the team prize with 45 points, mainly through the efforts of George Thorward, finalist, and T. T. Fauntleroy, winner of the consolations, each player scoring 15 points toward team score. University Club was second with 38 points. The tournament was followed by a large banquet presided over by Joe Foster, Jr., as toastmaster, which proved a brilliant ending to a splendid tennis season. All present voted to make the Rapid Fire tournament an annual affair.

With the war over and the return of Cleveland tennis players now in service, the C.A.T.C. are confidently looking forward to 1919 surpassing last year's record in interest and number of competitors.

## Cleveland City Championship

By B. F. THORWARD, PRESIDENT CLEVELAND ASSOCIATED TENNIS CLUBS.

S. W. Cabell again won the Cleveland city championship, held on the East End and University Club courts, beginning June 22, 1918. The entries comprised all the city's best talent, including several hard hitting juniors, but the persistent efforts and sound judgment of Cabell enabled him to cope successfully with their impetuous attacks. After one or two narrow escapes, due to lack of practice, his form improved, and he was able to put out both H. C. Wick and H. Botten in the semi-final and final, respectively.

Two juniors, H. Bartel and H. Hane, won the doubles in an exciting five-set match from Wick and Botten. It was a hard hitting contest throughout, with many errors on all sides, yet with so many thrilling rallies that the spectators were kept on edge throughout the match. Summaries:

### MEN'S SINGLES.

FIRST ROUND—H. Briggs d. B. W. Borleigh, 6/0,6/1; W. D. White d. H. Prescott, 7/5,6/2; F. W. Hawk d. E. J. Tyler, 7/5,4/6,6/2; E. A. Albrecht d. C. Kaercher, 6/4,6/2; G. T. Thorwood d. E. H. Ferris, 6/2,6/1; C. W. Miller d. P. W. Pfabl, 6/1,6/0; J. Foster, Jr., d. A. Van Duser, 6/1,4/6,6/1; H. Botten d. W. H. Bridgeman, 8/6,6/2; R. M. Rocky d. H. L. Parmenter, 6/3,6/1. SECOND ROUND—H. C. Wick, Jr., d. I. A. Greenwood, 7/5,8/6; V. Vernon d. J. M. Sands, 6/2,6/2; K. L. Hayes d. C. Bucher, 6/2,6/4; N. Dale d. F. W. Wagner, 6/2,6/2; S. W. Cabell d. A. W. Kovatch, 6/3,6/0; White d. Briggs, 8/6, 6/0; Hawk d. Albrecht, 7/5,4/6,6/2; Miller d. Thorwood, 6/3,6/3; Botten d. Foster, 6/2,8/6; Abbey d. Rocky, 8/6,7/5; S. Manchester d. Hobson, 6/2,6/0; R. L. Barker d. N. E. Amsden, 6/4,6/1; G. Minor d. E. C. Frank, 6/1,6/2; H. Hane d. B. Ulrich, 4/6,6/0,6/1; T. T. Fauntleroy d. D. Mouldin, 6/2,9/7. THIRD ROUND—Wick d. Vernon, 3/6,6/0,6/2; Dale d. F. W. Wagner, 6/4,6/2; Cabell d. White, 5/7,6/0,6/2; Miller d. Hawk, 6/0,6/4; Botten d. Abbey, 8/6,7/5; Manchester d. Barker, 6/3,6/1; Minor d. Hane, 3/6,6/3,6/3; Bartel d. Fauntleroy, 6/4,6/3. FOURTH ROUND—Wick d. Dale, 6/1,6/1; Cabell d. Miller, 1/6,6/4,8/6; Botten d. Manchester, 6/1,6/3; Minor d. Bartel, 6/3,6/4. SEMI-FINAL ROUND—Cabell d. Wick, 3/6, 6/4,6/4,6/1; Botten d. Minor, 1/6,9/7,6/3,6/4. FINAL ROUND—S. W. Cabell d. H. Botten, 6/2,6/3,1/6,6/0.

### MEN'S DOUBLES.

FIRST ROUND—White and Fuldheim d. Finley and Rocky, 6/4,6/3; Bartel and Hane d. Greenwood and Byers, 6/2,6/4. SECOND ROUND—Cabell and Abbey d. Fauntleroy and Wagner, 6/0,6/2; Marshall and Leo d. Apthorp and Apthorp, 6/0,6/0; Wick and Botten d.

Thorwood and Vernon, 6/4,6/3; Minor and Manchester d. White and Fuldheim, 3/6,6/3,6/2; Bartel and Hane d. Bridgeman and Barker, 6/0,6/4; Ulrich and Briggs d. Nason and Smith, 6/4,6/4; Sands and Malley d. Bucher and Fields, 6 4,14 12; Hobson and Hayes d. Weil and Weil, 6/0,6/1. THIRD ROUND—Cabell and Abbey d. Marshall and Leo, 6/4, 6/3; Wick and Botten d. Minor and Manchester, 3,6,6/3,6 2; Bartel and Hane d. Ulrich and Briggs, 6/3,6/4; Hobson and Hayes d. Sands and Malley, 6/2,7 5. SEMI-FINAL ROUND—Wick and Botten d. Cabell and Abbey, 6/3,7 9,6/4,6 2; Bartel and Hane d. Hobson and Hayes, 6/3,11/9,6/1. FINAL ROUND—H. Bartel and H. Hane d. H. C. Wick, Jr., and H. Botten, 3/6,6,3,6/4,3 6,6/3.

## Tennis in Indiana

BY CHARLES TRASK.

The only ones who could spare time to play tennis in Indiana in 1918 were the boys and juniors, the older players being either in war service or otherwise too busy to indulge in their favorite pastime. However, the juniors and boys were not neglected, and a very fine tournament was given for them. This tournament and the city championship of Indianapolis were the only events which were played in Indiana last year.

In the junior tournament, exceptional form was shown by John Hennessey, Minnie Cohn and Jack Petrovsky. Hennessey defeated Cohn in the semi-finals in a very interesting and hard fought four-set match. The weather was very bad during the week and it was necessary to play this match on the fine indoor court belonging to Mr. Carl G. Fisher. In the final, Petrovsky, who had won the interscholastic championship of Indiana, met Hennessey, and while there was no doubt as to the final outcome, the match was very interesting and closely contested. Petrovsky showed exceptional form in his forehand ground stroke. However, Hennessey's shots were too severe, both from his forehand and backhand, and he, taking advantage of any opportunity to come to the net, was able to hold the match well in hand. The match was decided in four very well played sets. The winning of this junior championship gave Hennessey the right to play in the national junior championship at New York.

The city tournament saw a few of the older players in action, but the greater majority were juniors, the total number entered being sixty. Nothing exceptional occurred until the finals, where the veteran, Gage Hoag, met John Hennessey, the State junior champion. Hoag was very steady, but Hennessey waited until he got one to his liking and then he would put it away for the point. He followed these tactics throughout the match and while it was very close, one could see from the play that Hennessey was the stronger of the two. In justice to Hoag, however, it must be said that he had played very little, and entered the tournament merely to try to make it a success. Hennessey lost the first set and won the next three and the match. By doing this he became the city champion, which is equivalent to the State championship.

In the boys' championship, three young players cropped out that ought to make very fine tennis players with proper training. They were Jack Thomas, Dick Hennessey and Hence Orme, Jr. The final outcome of the boys' tournament lay with one of these three and the honor went to Jack Thomas.

In September, Hennessey went to New York, where he played in the national junior championship, and in going through defeated Fred Anderson, who, I think, was considered the logical winner of the tournament. However, Hennessey succumbed to the attack of Harold Taylor in the final. This was the first time that Hennessey had ever played on grass, and this, together with his nervousness before a large audience in a strange place, probably did not help his game very much.

# Kentucky State Championships

BY CRIT C. YOUNG.

Owing to the heavy inroads made on the ranks of the local, Southern and Western tennis players by the war, it was found necessary to abandon all of the tournaments scheduled at Louisville except the Kentucky State championship event. However, this developed the best tennis played here in many years, as the entry list was composed almost entirely of men from Camp Zachary Taylor, Camp Knox and West Point, the three big army cantonments which are located here. They hailed from all parts of the country and embraced players who had gained more than reputations in their home cities.

The events that were played were men's singles and doubles, and although numerous civilians above the draft age participated, the prizes went to army officers.

In the men's singles final, Captain Middleton DeCamp, who had put up a smashing game all through the tournament, went to pieces, losing out in straight sets. In the semi-final round DeCamp played in brilliant style against Lieutenant F. L. Johnson of California, who is credited with several victories over McLoughlin and other stars. The sets were two to one against, and the game score in the third, 2-0, when DeCamp took a decided brace and ran a string of six consecutive victories. The next set went to him, 6/4. Shelton Arterburn, who held the championship for three years, was defeated in the second round by W. H. McAlpine. Following are the summaries:

## MEN'S SINGLES.

FIRST ROUND—Shelton B. Arterburn d. Dr. O. T. Turner, 3/6,6/1,6/4; W. H. McAlpine d. Lieut. J. L. Joureleman, 6/2,6/2; Thomas Fox d. Lieut. Stuart Williams, 5/7,6/4,6/3; H. T. Spears d. O. T. Eskew, 6/1,6/0; Capt. J. G. Wheeler d. F. H. Miller, 6/4,5/7,6/4; Lieut. L. F. Johnson d. Major George Eswald, 6/2,6/1; F. G. Dugan d. Lieut. Thomas M. Day, 6/3,8/6; C. A. Van Wagner d. Rozel Smith, 6/0,8/0; John O'Brien d. James Weaver, 6/2,10/8; Harry Embry d. Thomas Wilds, 6/0,6/1; Capt. Middleton DeCamp d. Carl Willenbrink, 6/1,6/3. SECOND ROUND—McAlpine d. Arterburn, 6/3, 3/6,6/3; Lieut. E. C. Perkins d. Fox, 6/2,6/2; Spears d. Wheeler, 6/1,6/3; Johnson d. Dugan, 6/2,6/2; Van Wagner d. D. H. Long, 6/3,6/1; Embry d. John O'Brien, 6/2,6/2; DeCamp d. William Boden, 6/1,6/1. THIRD ROUND—McAlpine d. Dorsey, 6/2,6/2; Perkins d. Spears, 6/4,5/7,6/4; Johnson d. Van Wagner, 1/6,6/1,6/0; DeCamp d. Embry, 6/4, 5/7,6/3. SEMI-FINAL ROUND—Perkins d. McAlpine, 2/6,6/4,6/4,6/4; DeCamp d. Johnson, 5/7,6/1,2/6,6/2,6/4. FINAL ROUND—Lieut. E. C. Perkins d. Capt. Middleton DeCamp, 6/2,8/6,6/1.

## MEN'S DOUBLES.

FIRST ROUND—Lieut. H. K. Grinstead and Lieut. Day d. Major Eswald and Miller, 6/2,6/4; Capt. DeCamp and Weaver d. Lieut. Joureleman and Yewell Rice, 6/4,8/6; Lieut. Williams and Lieut. Perkins d. A. H. Simons and Willenbrink, 6/2,6/2; Lieut. N. Maxwell and Spears d. Van Wagner and Dugan, 6/4,6/3; McAlpine and Embry d. Wilds and Henry Fisher, 7/5,6/2. SECOND ROUND—Lieut. Grinstead and Lieut. Day d. Arterburn and O'Brien, 8/6,6/8,10/8; Lieut. Williams and Lieut. Perkins d. Capt. DeCamp and Weaver, 7/5,3/6,6/4; Lieut. Maxwell and Spears d. McAlpine and Embry, 1/6,6/4,6/4. SEMI-FINAL ROUND—Lieut. Grinstead and Lieut. Day d. Williams and Perkins, 6/3, 7/5,2/6,7/5; Turner and Lieut. Johnson d. Maxwell and Spears, 8/6,6/2,6/2. FINAL ROUND—Lieut. H. K. Grinstead and Lieut. Thomas M. Day d. Dr. O. T. Turner and Lieut. L. F. Johnson, 6/3,6/3,2/6,7/5.

Ohio Intercollegiate Championships.—Ohio State, Ohio Wesleyan, Kenyon and Oberlin were represented in the 1918 competition for the Ohio intercollegiate championships. Wirthwein of Ohio State took the singles, defeating Marvin of Oberlin in the final round, 4/6,6/4,2/6,7/5,7/5. Wirthwein and Davis won the doubles from Havighurst and Lowry of Ohio Wesleyan, 7/5,6/2. Sidnell of Kenyon defeated Havighurst of Wesleyan in the consolation singles, 6/4,6/4.

## Western Tournaments

### Western Championships

All efforts failed to secure a single outside player of note for the Western championships, held at the Chicago Tennis Club, July 17 to August 5, 1918, although Tilden, Garland, Byford and Voshell all were considered possible entries up to the last moment.

The result was a repetition of the city championship, Walter Hayes again defeating Samuel Hardy in the final of the singles, while the Hayes-Burdick combination romped home in the doubles. Burdick was expected to give Hayes a hard fight in the semi-final, but failed to secure more than two or three games a set. Simultaneously, Edward Oelsner was giving Hardy the game of his life on the opposite court. Like Burdick in the city championship, he made the veteran produce all his cunning, headwork and tournament experience to win. This match proved to be the feature of the tournament and held the crowd for three full hours in a temperature over 90 degrees.

Oelsner forced the pace from the start, his terrific drives to the corners keeping Hardy on the defensive. With a lead of two sets, 8/6,6/4, he looked like the winner, but could not maintain the pace. Hardy, seizing his opportunity, in turn assumed the aggressive. Forcing the play to Oelsner's backhand at every opportunity, he then took the net for the finishing shot. At two-sets-all both men appeared spent, but Oelsner spurted and after long baseline duels led, 3/2 and forty-love. Hardy clung on and by pertinacity and a never-say-die spirit evened the score. This was Oelsner's final effort, and Hardy, now summoning his last reserves, took the net on his service and won the last two games with unexpected ease.

Hardy could not recuperate quickly enough to give Hayes much of a match the following day, and the latter won in straight sets by sound, consistent baseline play. Hardy, game to the core, fought to the end against hopeless odds. He forced the second set to 7-all and the third to 3-all, when he could run no further. Though he fought on to the last stroke, it was apparent to all that Hayes had only to prolong the rallies in order to win.

In the doubles, Lee Campbell, a promising South Park player, paired with Hardy and held up his end in a creditable manner until the semi-final, where, opposed to Hayes and Burdick, he seemed overcome with diffidence and did not play the strong game of which he is capable. They proved easy prey for the city champions, as did also Miller and Oelsner in the final. Burdick's brilliant smashing and Hayes' steady returns were the chief features of interest in both matches.

Miss Carrie B. Neely was the only noted Chicago player to enter the women's events, Mrs. McNeill, Miss Waldo, Miss Voorhies and Mrs. Miller failing to enter. This tournament was chiefly notable for the fine play of Mrs. W. I. Northup, for two years Oregon champion. Opposed to Miss Neely in the final, she acquitted herself in a most creditable manner. Her deep and well placed drives provided long rallies which delighted the spectators, but if forced to the net she was usually passed by her opponent. Miss Neely's resourcefulness and tournament experience were well illustrated in this match. Finding that a baseline game placed her on an equal footing with her opponent, she came to the net at every opportunity and dropped her return short, thus ending many rallies.



WALTER T. HAYES,  
Chicago.  
Western Champion.



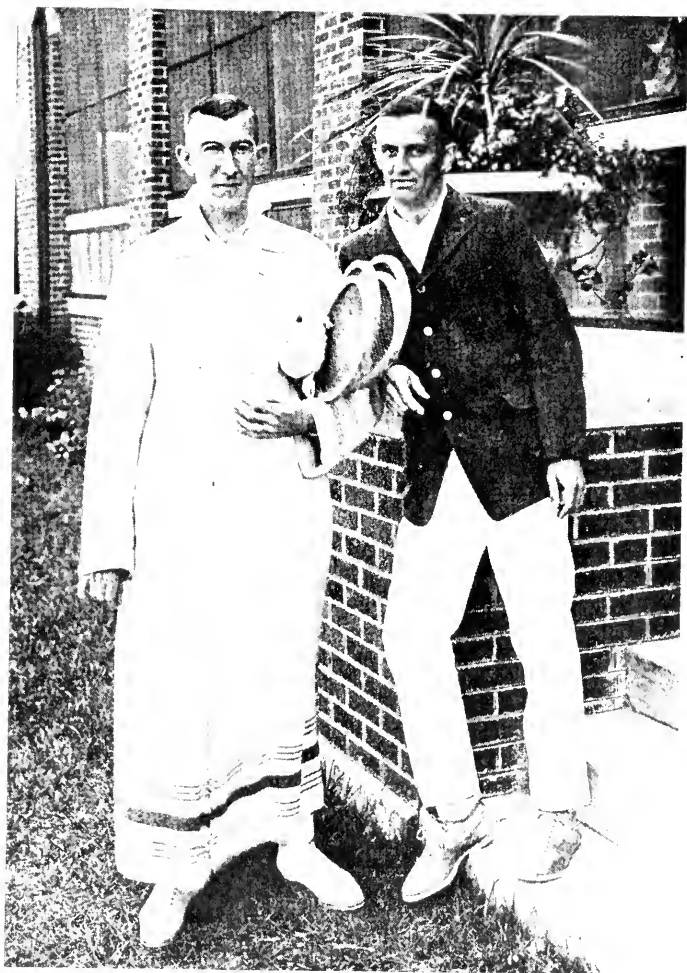

WALTER T. HAYES AND RALPH H. BURDICK,  
Western Champions; Runners-up United States Clay Court Championships.



6/1,6/2. SECOND ROUND—The Misses Scully d. Miss Catherine Neff and Miss Generva Conley, 6/3,6/4; Miss C. B. Neely and Mrs. W. I. Northup d. Miss Kreer and Miss Barrett, 6/2,6/0; Miss E. Timm and Mrs. E. Wiegel d. Miss L. Jess and Miss E. Blackman, 6/2,6/3. SEMI-FINAL ROUND—Miss Leighton and Mrs. Field d. The Misses Scully, 6/0, 3/6,6/3; Miss Neely and Mrs. Northup d. Miss Timm and Mrs. Wiegel, 6/4,6/0. FINAL ROUND—Miss M. F. Leighton and Mrs. Ralph Field d. Miss C. B. Neely and Mrs. W. I. Northup, 7/5,4/6,7/5.

## Illinois State Championships

Walter T. Hayes won the Illinois State championship, held at the Edgewater Beach Hotel, Chicago, September 7-15, 1918, without the loss of a set, thus gaining permanent possession of the three-year trophy presented by A. G. Spalding & Bros. in 1912.

The two former Illinois champions, Byford and Squair, were in service, while Hardy and Burdick were away on their vacations. Consequently Hayes experienced little difficulty in coming through the small field. The Michigan State champion, Walter Westbrook, succumbed to Oelsner's terrific drives in the semi-final, while Lucian Williams distinguished himself by a fine win over Harry Waidner. In his match with Hayes he was unable to secure a set, though he forced him to 8/6 in the second. The final found Hayes at the top of his game and he fairly smothered Oelsner, who gained but three games in as many sets.

In the men's doubles, Hayes paired with George O'Connell, a junior of Jackson Park. After dropping the first set in their final match against Oelsner and Woods, O'Connell settled down to steady play under Hayes' tutelage. They won the next three sets in a spirited match, in which O'Connell came in for a large share of the gallery's applause. It is to be hoped that other noted players will emulate Hayes' example in thus encouraging junior tennis. Hayes could easily have secured a more noted partner, and it is gratifying that his sportsmanship had its reward in victory.

Mrs. McNeill, city champion, was the winner in both women's events. After dropping the first set of her first match to Miss Rose Fogelson at 5/7, she won her way through to the final with ease. There Miss Marion Leighton, who had lost the first set to love, carried the second to 6-all before succumbing to her more experienced opponent. Miss Katherine Waudo partnered Mrs. McNeill in the women's doubles, which they won without the loss of a set. In the final they met Mrs. Ralph Field and Miss Marion Leighton, whom they defeated after a hard struggle, 9/7,6/4. The summaries:

### MEN'S SINGLES.

FIRST ROUND—Orville Seiter d. P. H. Maas, 6/3,2,6,6/0; C. O. Carlstrom d. H. Pinney, 5/7,6/4,7/5; George O'Connell d. L. C. Nutter, 6/1,6/4; W. T. Hayes d. Wilbur Jackson, 6/1,6/1; L. B. Walton d. James Anderson, 6/0,6/0; O. O. Sheline d. Noble Shumway, 0/6, 6/3,6/2; Arthur Ries d. L. D. Leavitt, 6/1,6/4; Lucian Williams d. L. B. Gallison, 6/1,6/0; E. H. Fabrice d. Eugene Peirsel, 9/7,5,7,6/3; Marvin Joyce d. R. G. Behrens, 6/1,6/1; Perry Segal d. C. W. Harrison, 6/4,6/3; J. P. Benson d. Nate Salisbury, 6/3,6/2; Charles Trimble d. D. Taylor Ward, 6/1,2,6,6/4; R. F. Woods d. Ben Adler, 6/2,6/4. SECOND ROUND—A. P. Hubbell d. Seiter, 6/1,6/0; O'Connell d. Carlstrom, 6/4,2,6,7/5; Hayes d. E. J. Hartney, 6/1,6/1; Alonzo Stagg, Jr., d. F. S. Crane by default; L. H. Waidner d. Harold Forster, 6/2,7/5; Walton d. Sheline, 7/5,6/1; Ries d. Leo J. Lunn, 6/3,6/3; Williams d. F. H. Montgomery, 6/3,6/1; Fabrice d. Joyce, 7/5,7,5; Edward Oelsner d. J. R. McKnight, 6/3,6/0; H. S. Walsh d. Frank Weadley, 7/5,8,10,7/5; Jack Harris d. Lee Campbell by default; Segal d. E. W. Wilson, 6/2,6/0; Benson d. R. H. Burdick by default; Walter Westbrook d. A. H. Miller by default; Woods d. Trimble, 2/6,6,2,6/2. THIRD ROUND—Hubbell d. O'Connell, 6/1,6/2; Hayes d. Stagg, 6/0,6/2; Waidner d. Walton, 6/0, 6/4; Williams d. Ries, 3/6,6,4,6/3; Oelsner d. Fabrice, 4/6,6,1,7/5; Walsh d. Harris, 4/6, 6/3,6/0; Segal d. P. Benson, 6/4,5,7,6/4; Westbrook d. Woods, 6/3,6/3. FOURTH ROUND—Hayes d. Hubbell, 6/2,6/3; Williams d. Waidner, 7/9,6,4,7/5; Oelsner d. Walsh, 6/1,6/2; Westbrook d. Segal, 6/1,6/4. SEMI-FINAL ROUND—Hayes d. Williams, 6/1,8,6,6/2; Oelsner d. Westbrook, 7/5,2,6,7,5,7/5. FINAL ROUND—Walter T. Hayes d. Edward Oelsner, 6 2 6 1 6 0.

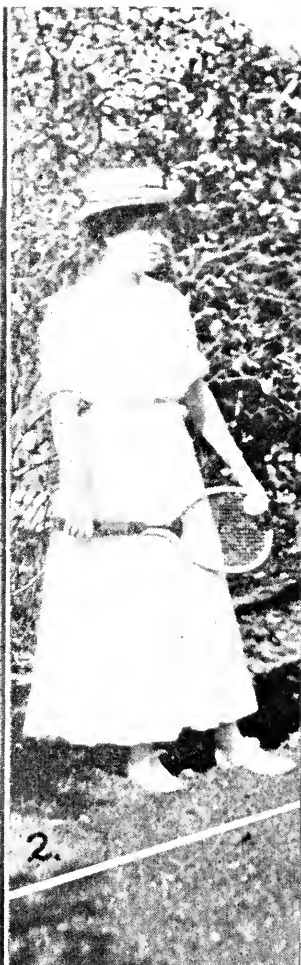

1. Miss Corinne Gould, St. Louis; Missouri State, Central West, Central States and St. Louis City Champion. 2. Miss Carrie B. Neely, Chicago; Western Champion.

## MEN'S DOUBLES.

FIRST ROUND—Williams and Westbrook d. Sheline and Hartney, 6/1,7/5; Hayes and O'Connell d. Carlstrom and Peirsel, 6/1,6/4. SECOND ROUND—Westbrook and Williams d. Salisbury and Jackson, 6/2,6/2; Oelsner and Woods d. Forster and McKnight by default; England and Walton d. Fabrice and Ries, 6/3,6/4; Hayes and O'Connell d. Lunn and Gallison, 6/2,6/0. SEMI-FINAL ROUND—Oelsner and Woods d. Westbrook and Williams, 6/3,6/3,6/1; Hayes and O'Connell d. England and Walton, 6/1,6/1,6/4. FINAL ROUND—Walter T. Hayes and George O'Connell d. Edward Oelsner and R. F. Woods, 2/6,6/3,6/4,7/5.

## WOMEN'S SINGLES.

FIRST ROUND—Miss E. Scully d. Miss Dorothea Wahl, 6/4,8/10,6/1; Mrs. M. McNeill d. Miss Rose Fogelson, 5/7,6/3,6/2; Miss L. Phillips d. Mrs. C. W. Fowler, 6/1,7/5. SECOND ROUND—Miss Barbara Miller d. Miss E. Timm, 7/5,4/6,6/4; Mrs. McNeill d. Mrs. H. S. Adams, 6/3,7/5; Miss Marion Leighton d. Miss L. Phillips, 6/2,6/1; Miss Krekel d. Mrs. Oelsner, 6/3,6/1; Miss K. Waldo d. Mrs. Wiegler, 6/3,7/5. THIRD ROUND—Mrs. Field d. Miss Barbara Miller, 6/4,6/4; Mrs. McNeill d. Miss E. Scully by default; Miss Leighton d. Miss M. Scully by default; Miss Waldo d. Miss Krekel, 6/1,6/1. SEMI-FINAL ROUND—Mrs. McNeill d. Mrs. Field, 6/3,6/3; Miss Leighton d. Miss Waldo, 7/5, 6/4. FINAL ROUND—Mrs. Malcolm McNeill d. Miss Marion Leighton, 6/0,8/6.

## WOMEN'S DOUBLES.

FIRST ROUND—Mrs. Field and Miss Leighton d. Miss Krekel and Miss Phillips, 6/0, 6/1; Miss Waldo and Mrs. McNeill d. Mrs. Adams and Miss Miller, 6/3,8/6. SEMI-FINAL ROUND—Mrs. Field and Miss Leighton d. Miss Dunlavey and Miss Wahl, 6/1,6/3; Miss Waldo and Mrs. McNeill d. Mrs. Wiegler and Miss Timm, 6/1,6/2. FINAL ROUND—Miss Katherine Waldo and Mrs. Malcolm McNeill d. Mrs. Ralph Field and Miss Marion Leighton, 9/7,6/4.

## Chicago City Championships

Walter Hayes began a most successful season by winning the singles and, with his partner, the doubles in the 1918 city championships, played at the Chicago Tennis Club, June 8 to 16, inclusive. A lucky drawing gave him easy matches until the final, while the other chief contenders for the title—Hardy, Burdick, Oelsner and Miller—struggled against each other in the opposite half. The best match of the tournament was in the semi-final, where Hardy exhausted himself in a three-hour match with Burdick. The following day Hayes found Hardy an easy victim, defeating him with comparative ease in straight sets by careful, steady play.

Hayes and Burdick revenged themselves upon Waidner and Hardy for their previous year's win by a straight-set victory in the semi-final, and won the final against Miller and Forstall with the loss of but seven games.

Mrs. Malcolm McNeill won the women's singles from a field comprising Chicago's best players. She seemed to find her old-time form, winning her three matches with the loss of but five games. Miss Katherine Waldo deserves much credit for her win over Miss Carrie B. Neely, though the latter was handicapped by the loss of her glasses. Winning at 8/6, 7/5, she was too spent to do herself justice in the final against Mrs. McNeill, whose fine, steady play gave promise of victories in later tournaments.

Miss Neely and Miss Waldo won the women's doubles without the loss of a set, while Miss Marion Leighton, who with a little more experience should become a champion, won the mixed with Edward Oelsner.

The boys' and juniors' sectional tournaments, which had been going on during the previous week in several sections of the city, were completed at this time. Milton Agay, by his aggressive net game, gained the junior title, his hardest match being in the final, against J. R. McKnight.

The boys' singles was won by Bradley Guyton of Jackson Park, who defeated Minard McNeill, son of Mrs. Malcolm McNeill, in the final. Guyton displayed

a high order of play and generalship for a boy of fifteen. He is indebted to his father, O. F. Guyton, for much of his tennis training, and many players would like to see them enter the national father and son tournament. The summaries:

#### MEN'S SINGLES.

FIRST ROUND—Pierce Ward d. M. J. Gormley, 6/2,6/4; Guy Blake d. Dr. W. G. Burkhardt, 6/4,3/6,6/3; Art Hubbell d. Dr. R. J. C. Hamilton, 6/0,6/0; Wilbur Jackson d. J. F. Ashworth, 6/0,6/2; George J. O'Connell d. W. S. Hubbard, 6/2,3/6,6/3; H. F. Prussing d. A. W. Reid, 6/3,6/2; W. T. Hayes d. L. R. Campbell, 6/1,6/3; J. Samuels d. N. D. Browne, 6/0,6/4; D. Taylor Ward d. J. R. McKnight, 4/6,6/4,6/3; O. Chatfield Taylor d. R. D. Murphy, 6/0,6/2; E. B. Peirsel d. Leo Lunn, 8/6,6/4; Sam Hardy d. Perry Segal, 6/1,6/3; George Hunt d. I. W. Hadsell, 8/6,2/6,8/6; H. D. Pettibone d. C. T. Davis, 6/2, 6/2; L. Murphy d. Frank Rose, 7/5,6/1; Edward Oelsner d. C. E. Wilson, 6/1,6/0. SECOND ROUND—R. G. England d. Paul Thompson, 6/1,6/3; Ward d. Blake, 6/3,6/1; Hubbell d. Jackson, 6/0,6/3; O'Connell d. Prussing, 6/4,6/2; Hayes d. Samuels, 6/0,6/2; H. L. Groves d. R. C. Boozer, 6/4,6/4; Ward d. George Neeves by default; Don Wiley d. P. C. Campbell, 6/1,6/0; W. S. Miller d. Taylor, 6/2,6/3; Peirsel d. Frank Weadley, 6/4,6/8,8/6; Hardy d. Hunt, 6/1,6/0; L. Murphy d. Pettibone, 6/0,6/1; Oelsner d. R. F. Woods, 6/4, 6/4; Stanley H. Drake d. F. W. Gookin, 6/0,6/2; R. H. Burdick d. Harold Forster by default; C. O. Carlstrom d. A. L. Klewer, 6/3,6/1. THIRD ROUND—England d. Ward, 6/0,6/1; Hubbell d. O'Connell, 6/4,6/2; Hayes d. Groves, 6/0,6/3; Ward d. Don Wiley, 6/3, 2/6,6/2; Miller d. Peirsel, 6/0,6/0; Hardy d. L. Murphy, 6/3,6/1; Oelsner d. Drake, 6/2,6/4; Burdick d. Carlstrom, 6/1,6/2. FOURTH ROUND—Hubbell d. England, 6/3,6/0; Hayes d. Ward, 9/7, 6/0; Hardy d. W. S. Miller, 6/2,6/1; Burdick d. Oelsner, 6/0,6/3. SEMI-FINAL ROUND—Hayes d. Hubbell, 6/1,6/2,6/4; Hardy d. Burdick, 2/6,6/4,6/2,6/8,6/4. FINAL ROUND—Walter Hayes d. Samuel Hardy, 6/4,6/3,6/4.

#### MEN'S DOUBLES.

FIRST ROUND—Leo Lunn and C. R. Pierce d. E. B. Peirsel and W. Jackson, 6/2,0/6, 10/8; R. F. Woods and O. Chatfield Taylor d. J. Samuels and N. D. Browne, 6/1,6/2; Sam Hardy and L. Waidner d. C. O. Carlstrom and Frank Weadley, 6/3,6/2; Harry Prussing and Ralph Boozer d. Stanley Drake and Fred Wilber, 6/2,4/6,6/0; Pierce C. Ward and Don Wiley d. R. G. England and L. B. Walton, 8/6,7/5. SECOND ROUND—Walter Hayes and Ralph Burdick d. G. J. O'Connell and J. P. Benson, 6/2,6/2; D. Taylor Ward and I. W. Hadsell d. Perry Segal and partner by default; Woods and Taylor d. Lunn and Pierce, 6/2,6/2; Hardy and Waidner d. C. E. Wilson and McKnight, 6/1,6/1; L. R. Campbell and L. E. Murphy d. Clarence Cole and W. J. Hoppe, 6/2,6/1; Edward Oelsner and Arthur Hubbell d. Prussing and Boozer by default; Wiley and Ward d. C. T. Davis and S. C. Hancock by default; James Forstall and W. S. Miller d. M. J. Gormley and W. S. Hubbard, 6/1,6/2. THIRD ROUND—Hayes and Burdick d. Ward and Hadsell, 6/0,6/3; Hardy and Waidner d. Woods and Taylor, 6/1,6/1; Oelsner and Hubbell d. Campbell and Murphy, 6/4,6/8,6/3; Forstall and Miller d. Wiley and Ward, 6/1,6/0. SEMI-FINAL ROUND—Hayes and Burdick d. Hardy and Waidner, 6/4,6/2,9/7; Forstall and Miller d. Oelsner and Hubbell, 9/7,4/6,2/6,6/3,6/1. FINAL ROUND—Walter Hayes and Ralph Burdick d. James Forstall and W. S. Miller, 6/0,6/3,6/4.

#### WOMEN'S SINGLES.

FIRST ROUND—Miss Marion Leighton d. Mrs. W. T. Hayes, 6/1,6/2; Miss Carrie B. Neely d. Miss Katherine Schmidt, 6/2,6/1; Mrs. Nell Lathrop Forstall d. Miss Dorothea Davies, 6/3,6/1. SECOND ROUND—Mrs. Malcolm McNeill d. Miss Emily Scully, 6/3,6/0; Miss Leighton d. Mrs. E. Wiegler by default; Miss Neely d. Mrs. Forstall, 6/0,6/1; Miss Waldo d. Miss E. Carla Timm, 6/4,6/1. SEMI-FINAL ROUND—Mrs. McNeill d. Miss Leighton, 6/0,6/1; Miss Katherine Waldo d. Miss Neely, 8/6,7/5. FINAL ROUND—Mrs. Malcolm McNeill d. Miss Katherine Waldo, 6/0,6/1.

#### WOMEN'S DOUBLES.

SEMI-FINAL ROUND—Miss Carrie B. Neely and Miss Katherine Waldo d. Miss Emily Scully and Mrs. Malcolm McNeill, 6/1,9/7; Miss Leighton and Miss Falker d. Miss Emily Timm and Mrs. E. Wiegler, 6/1,6/0. FINAL ROUND—Miss Carrie B. Neely and Miss Katherine Waldo d. Miss Leighton and Miss Falker, 6/3,9/7.

#### MIXED DOUBLES.

FIRST ROUND—Miss Emily Scully and Edward Fabrice d. Mr. and Mrs. Walter Hayes, 6/3,8/6; Miss Kathryn Schmidt and R. F. Woods d. Miss Nell Lathrop Forstall and James Forstall, 8/6,6/1. SEMI-FINAL ROUND—Miss Marion Leighton and Edward Oelsner d. Miss Scully and Fabrice by default; Mrs. Malcolm McNeill, Jr., and E. B. Peirsel d. Miss Schmidt and Woods, 10/8,4/6,6/4. FINAL ROUND—Miss Marion Leighton and Edward Oelsner d. Mrs. Malcolm McNeill and E. B. Peirsel, 6/1,7/5.

## JUNIOR SINGLES.

FIRST ROUND—Joseph McCain d. Gilbert Rosenthal, 6/1,7/5; J. R. McKnight d. Henry Magneson, 6/2,6/0; Milton Agay d. Fred Jaycox, 6/0,6/1; Gair Tourtellot d. James Anderson, 6/2,7/5. SEMI-FINAL ROUND—McKnight d. McCain, 6/3,6/4; Agay d. Tourtellot, 6/1,6/1. FINAL ROUND—Milton Agay d. J. R. McKnight, 6/4,6/2.

## BOYS' SINGLES.

FIRST ROUND—Minard McNeill d. William Frisbie, 6/4,6/4; Jack Rodeheaver d. Art Wold, 6/4,6/2. SEMI-FINAL ROUND—McNeill d. Rodeheaver, 6/4,6/2; Bradley Guyton d. Kline, 6/0,6/0. FINAL ROUND—Bradley Guyton d. Minard McNeill, 6/4,6/2.

## Chicago Tennis Association

BY WILBUR JACKSON, SECRETARY.

The Chicago Tennis Association entered upon the fifth year of its existence with nineteen active clubs and several associate clubs. Two active clubs dropped out, one the Midway Tennis Club, whose entire team was in service, the other the Elmwood, owing to difficulty in securing grounds; but the Harvester and Homan clubs came in, thus keeping the number of active clubs up to that of the previous season.

Immediately after his election to the presidency, C. R. Pierce initiated the policy of holding open board meetings at weekly luncheons, which were attended by an average of twenty interested tennis players. This plan proved to be the means of keeping interest in tennis alive during the winter months.

The first important step was the decision to hold a benefit for Chicago tennis players in service. This was held at the Chicago Arena, the largest and handsomest ice skating rink in America, and was attended by more than 2,000 persons. The feature of the event was a doubles match of tennis on ice between Hayes and Burdick, Western champions, and Oelsner and Kenfield, winners of the Chicago Tennis Association doubles championship, the former pair winning. There was also an exhibition of fancy skating by E. H. Fabrice of the Chicago Tennis Club. The event was such a decided success that another benefit was held a month later, the feature being a doubles tournament on ice, sixteen teams entering. Six double courts were marked out and play continued every evening until the tournament was finished. Hayes and Burdick won, thus keeping their record clean on both land and water.

During the winter months an indoor tournament was held on the concrete courts of the Municipal Pier. The singles went to M. G. Ketchum and the doubles to Ketchum and L. C. Nutter, the popular secretary of the association.

In the interclub matches, the clubs were reclassified according to their playing strength, instead of being geographically arranged as in the past. Class A, representing the strongest division, played the major schedule of six events in singles and three in doubles, and was won by the Chicago Tennis Club. This team came through the season without losing a match and also won the special match against the all-star team picked from all other clubs in Division A. Division B played the same schedule and was won by the Unatre Club, which won every match. The winner of Class B goes into Class A next season, and the team with the lowest record in Class A drops to Class B. The C division, playing a lighter schedule of three events in singles and two in doubles, was won by the Austin Tennis Club, whose team lost only one set throughout the season.

In the closed tournament, open only to players who had represented the various clubs in interclub play, the singles returned Ed Oelsner, Chicago Club,



HARRY S. KNOX,  
Vice-President South Side Tennis Club,  
President Chicago Tennis Association.

R. L. VAN ARSDALE,  
President South Side Tennis Club,  
Chicago.

winner, who, teamed with Don Wiley of the same club, won the doubles. The first Chicago Veterans' tournament was held, the singles being won by George W. Byington of Irving Park. This was a very popular victory, as he had been a hard worker for the association and was one of its organizers. The doubles went to Carr and Forbrich of the Washington Park Club.

The other activities of the association included the publication of a special Chicago number of *Tennis Review*, the compilation of which was entrusted to the worthy hands of Leo Lund, and a directory of Chicago tennis players, the first ever published. This has proved very helpful to committees in charge of tournaments, as it contains not only addresses but telephone numbers. The association prepared a special die for medals and fobs to be awarded as prizes in all tournaments held under its auspices. Daily papers were sent to the ambulance units of which Chicago players were members and were highly appreciated, as many letters in the secretary's office testify. Also, tennis equipment was collected and sent to the army camps. The association also finances the project of sending Chicago players to participate in the national singles and doubles, Hayes and Burdick being selected.

In addition to the regular schedule of interclub matches, the association conducted the following tournaments: City, State, Boys' and Juniors', Veterans', Lawchester Red Cross, South Park, Indoor, and West Maywood. The following officers were elected for the 1919 season: R. L. Van Arsdale, president; L. C. Nutter, vice-president; Wilbur Jackson, secretary; L. R. Hayes, treasurer. Directors—J. C. Stewart, P. H. Maas, F. G. Wilber, E. H. Fabrice, Alam MacFarlane.

President Van Arsdale resigned January 31, owing to pressure of business, and Harry S. Knox, vice-president of the South Side Tennis Club, was appointed to fill the unexpired term.

For the first time in the history of Chicago tennis, an attempt was made to rank the players. Fifty-five men were ranked, the first ten being, in their order of merit:

- |                     |                   |                      |
|---------------------|-------------------|----------------------|
| 1. WALTER T. HAYES. | 5. A. HUBBELL.    | 8. D. T. WARD.       |
| 2. SAMUEL HARDY.    | 6. W. S. MILLER.  | 9. GEORGE O'CONNELL. |
| 3. RALPH BURDICK.   | 7. L. H. WAIDNER. | 10. DON WILEY.       |
| 4. E. OELSNER.      |                   |                      |

### RESULTS OF INTERCLUB MATCHES.

#### DIVISION A.

|                   | Matches. |    | Sets. |    |                     | Matches. |    | Sets. |    |
|-------------------|----------|----|-------|----|---------------------|----------|----|-------|----|
|                   | W.       | L. | W.    | L. |                     | W.       | L. | W.    | L. |
| Chicago T.C. .... | 6        | 0  | 48    | 6  | Hamilton Park ..... | 1        | 5  | 14    | 40 |
| South Park .....  | 5        | 1  | 39    | 15 | Homan A.C. ....     | 1        | 5  | 13    | 41 |
| South Side .....  | 4        | 2  | 32    | 22 | River Forest .....  | 1        | 5  | 10    | 44 |
| Sherwood .....    | 3        | 2  | 33    | 21 |                     |          |    |       |    |

#### DIVISION B.

|                     |   |   |    |    |                    |   |   |    |    |
|---------------------|---|---|----|----|--------------------|---|---|----|----|
| Unatre .....        | 7 | 0 | 44 | 19 | West Maywood ..... | 3 | 4 | 33 | 30 |
| Speedway .....      | 6 | 1 | 43 | 20 | Lawchester .....   | 2 | 5 | 23 | 40 |
| Washington Park.... | 5 | 2 | 43 | 20 | Wilson Avenue "Y". | 1 | 6 | 18 | 45 |
| Rogers Park .....   | 3 | 4 | 34 | 29 | Minocqua .....     | 1 | 6 | 14 | 49 |

#### DIVISION C.

|                 |   |   |    |   |                    |   |   |    |    |
|-----------------|---|---|----|---|--------------------|---|---|----|----|
| Austin .....    | 5 | 0 | 24 | 1 | Albany Park .....  | 2 | 3 | 12 | 13 |
| Harvester ..... | 2 | 1 | 9  | 6 | North Oak Park.... | 0 | 5 | 0  | 25 |

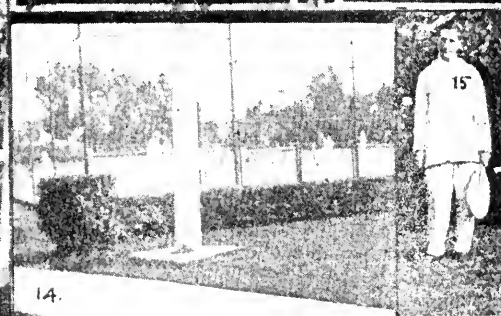

1, Wilbur Jackson, Secretary Chicago Tennis Association. 2, L. D. Leavitt; 3, G. W. Fowler—Jackson Park doubles team. 4, Edward Oelsner, winner Chicago Tennis Association's closed tournament. JACKSON PARK TENNIS TEAM, Chicago Public Parks Tennis Champions, 1918-5, R. Parks: 6, F. Pearson 7, L. D. Leavitt, Capt.; 8, B. Guyton; 9, O. F. Guyton; 10, G. W. Fowler. 11, George O'Connell, Illinois State Doubles Champion. 12, Bradley Guyton Chicago Boys' Champion. 13, James R. P. McKnight, Runner-up Chicago Junior Championship. 14, View of Cynwyd (Pa.) Club courts. 15, P. S. Osborne, Captain Belfield C.C. team.



## CHICAGO TENNIS ASSOCIATION CLOSED TOURNAMENT.

## MEN'S SINGLES.

FIRST ROUND—Oelsner d. Youngquist, 6/0,6/0; Pinney d. Gordon, 6/1,6/2; Ward d. George Woods, 4,6,8 6,6/4; R. F. Woods d. Stanton, 6/2,6/0; England d. Tannebaum, 6/3, 6/3; Hubbell d. Kramer, 6/2,6/1; Miller d. Hultman, 6/2,6/1; O'Connell d. Gallison, 6/3, 6/2; L. C. Nutter d. Walton, 6/8,6/3,6/4; Carlstrom d. Magnussen, 6/0,6/1; Crane d. Jackson, 6/3,6/1; Joyce d. Kohn, 7/5,6/2. SECOND ROUND—Wiley d. Mertz, 6/3,4/6,6/3; Oelsner d. Berns, 6/1,6 1. Pinney d. Curran, 6/1,6/1; Ward d. Rohner, 6/4,6/3; Woods d. Forster, 6/1,6/3; Benson d. Sheline, 2/6,7/5,7/5; Hubbell d. England, 6/4,6/3; Miller d. O'Connell, 6/3,6/1; Carlstrom d. Nutter, 6/1,6/1; Crane d. Joyce, 7/5,6/2. THIRD ROUND—Carlstrom d. Crane, 6/4,6/3; Ward d. Pinney, 4/6,6/1,6/4. FOURTH ROUND—Ward d. Carlstrom, 7/5,7/5; Oelsner d. Wiley, 2/6,6/2,6/3; Hubbell d. Miller, 6/4,6/4; Benson d. Woods, 6/3,6/4. SEMI-FINAL ROUND—Hubbell d. Benson, 6/1,6/3,6/2; Oelsner d. Ward, 6/0,6/4,6/4. FINAL ROUND—Edward Oelsner d. Art Hubbell, 6/2,6/2,6/3.

## MEN'S DOUBLES.

FIRST ROUND—Jackson and Adams d. Joyce and Gilmour, 6/0,6/3; Hultman and Magnussen d. Calleen and Schmidt, 7/5,6/8,6/4; Ebeling and Hartney d. Crane and Trimble, 6/3,7/9,8/6; Hubbell and Cochran d. Mertz and Tannebaum, 6/3,6/3. SECOND ROUND—Oelsner and Wiley d. England and Walton, 1/6,9/7,6/4; Campbell and Adler d. Jackson and Adams, 6/2,0/6,6/2; Ebeling and Hartney d. Hultman and Magnussen, 6/2,6/3; Hubbell and Cochran won by default. SEMI-FINAL ROUND—Oelsner and Wiley d. Campbell and Adler, 6/3,6/4,6/4; Hubbell and Cochran d. Ebeling and Hartney, 6/3,2/6,6/4,6/1. FINAL ROUND—Edward Oelsner and Don F. Wiley d. Art Hubbell and T. H. Cochran, 6/3,3/6,5/7,6/4,6/2.

## Chicago Public Parks Association

BY L. D. LEAVITT.

The Chicago Public Parks Tennis Association completed its third successful season under the direction of the following officers: H. A. Silver, president; J. O. McKiernan, vice-president; H. A. Bach, secretary and treasurer; L. D. Leavitt, chairman of Tournament Committee.

In spite of many adverse conditions, eleven clubs, the same number as the previous season, played their schedules without a single forfeit. The season



SOUTH PARK TENNIS CLUB CHICAGO,

Finalists in Interclub Matches.

opened June 1 and closed August 3, 1918, all matches being played on Saturday or Sunday of each week.

In the Northern Division there was a new winner in Garfield Park, this team going through the season with a clean slate of eight wins and the loss of but two individual matches in forty played. In the Southern Division, Jackson Park's team of veteran players made an even better showing, repeating their previous season's victory with ten matches won and none lost, and the loss of but three individual matches in fifty played.

The play-off between Jackson and Garfield parks for the public parks championship was held on the courts of the South Park Tennis Club and resulted in a clean sweep of all five events for Jackson Park, the scores being as follows: Singles—R. Parks d. C. J. Dolan, 6/4,6/1,6/3; Bradley Guyton d. Alferdro Marasigan, 6/1,6/3,6/2; O. F. Guyton d. J. O. McKiernan, 6/2,6/3,6/2. Doubles—C. W. Fowler and L. D. Leavitt d. L. E. Daniel and W. H. Ruth, 6/4,6/3,6/4; O. F. Guyton and F. Pearson d. A. Marasigan and L. Llalano.

On the whole, the play was fully up to the standard of previous seasons and several promising young players were developed, who are sure to be heard from in a few years, Ralph Guyton of Jackson Park and Ralph Rice of Speedway showing up best. In a year or two they should make valuable members for any team. Following is the final standing of teams:

| SOUTHERN DIVISION. |      |       |                 | NORTHERN DIVISION. |                  |       |                 |    |    |
|--------------------|------|-------|-----------------|--------------------|------------------|-------|-----------------|----|----|
|                    | Won. | Lost. | Indiv. Matches. |                    | Won.             | Lost. | Indiv. Matches. |    |    |
| Jackson .....      | 10   | 0     | 47              | 3                  | Garfield .....   | 8     | 0               | 38 | 2  |
| Palmer .....       | 7    | 3     | 36              | 14                 | Mozart .....     | 6     | 2               | 29 | 11 |
| Washington .....   | 5    | 5     | 27              | 23                 | Kosciusko .....  | 4     | 4               | 23 | 17 |
| Ogden .....        | 3    | 7     | 19              | 31                 | Fuller .....     | 2     | 6               | 10 | 30 |
| Speedway .....     | 3    | 7     | 14              | 36                 | Hardin Square... | 0     | 8               | 0  | 40 |
| Trumbull .....     | 2    | 8     | 9               | 41                 |                  |       |                 |    |    |

## Tennis in Detroit

BY N. H. BOWEN.

Tennis had a much better year in Detroit in 1918 than might have been anticipated. The redeeming features, helping to balance the absence of many good players, were the lively interest maintained by most of those not in military service, especially the younger generation, and the fact that Walter Westbrook had the best season a Detroit player perhaps has ever enjoyed, winning tournaments East and West and taking a place in the country's "third ten" in singles, by grace of the Ranking Committee, while in doubles he and James of Syracuse were placed seventh in the United States. Westbrook showed marked improvement over his previous playing and will go still higher in the future, in the judgment of experienced critics.

There were fewer tennis events than usual, though the city and State tournaments were conducted as in previous years, and the Detroit Tennis Club participated in the League of the Lower Lakes events at Buffalo. But the usual team events with Toledo, University of Michigan and other nearby teams were dropped for the year.

The city tournament was held in September with a fair entry, but the play was rather mediocre with the exception of the final match, in which R. H. Doughty, the old State and city title holder, "came back" after being out of the big events for two or three years and made a splendid fight against his younger opponent, Westbrook. When he was in his stride, Doughty gave

Westbrook far more of a battle than anyone else had done in Detroit during the year; in fact, had the better of him while he could maintain the pace, but he was rather unsteady except in one set—the third—which he won in fine style. Westbrook was not spectacular in this match, but was careful and accurate, making fewer mistakes than Doughty. The scores:

Semi-final Round—Westbrook d. Raseman, 6/2,6/2; Doughty d. Dean Emerson, 6/2,6/2.  
Final Round—Westbrook d. Doughty, 8,6,6/2,3/6,6/2. No doubles or women's events were played.

The usual junior and boys' events were held, the winners of the preliminary tournaments playing off at the State tournament. The final scores:

Juniors—Lewis Munz d. George Reindel, 1,6,6/4,8,6,2,6,6/4. Boys—Paul Jerome d. J. L. Zemon, 6/4,6/3,6/4.

Westbrook's career for the season was a brilliant one, as he won the singles honors in the New England, Michigan, West Michigan and Detroit tournaments, and the doubles in the New England, Connecticut Valley, West Michigan and Ohio events. Besides, he all but won the Ohio championship in singles, having the veteran Sam Hardy two sets to one when he developed a bad case of cramps and ultimately had to default. It was the general verdict that he outplayed Hardy in this match up to the time he was incapacitated. In the Massachusetts doubles, also, he made a fine showing with Theodore Lightner, a Detroit boy, the pair all but beating Harry Johnson and Irving Wright, the crack Boston team.

The biggest event of the year in Detroit, as far as numbers went, was the parks tournament, conducted by the City Recreation Commission, which is taking a most commendable interest in tennis. Ten events were staged, the total entry list including nearly one hundred individuals, representing Northwestern, Atkinson, Water Works, Edison, Belle Isle, Packards, Burroughs and Ford tennis clubs. More interest is being shown in this tournament each year, and with the returning of the boys from war service the 1919 tournament should be a record-breaker. The final scores of the various events were as follows:

Men's Singles—S. L. Ferguson d. H. H. Hutchison, 7/5,6/4,3/6,6/4. Men's Doubles—H. H. Hutchison and I. Van Tassel d. J. B. Lee and S. B. Seay, 6/4,8/6,10/8. Women's Singles—Miss Marian Gams d. Mrs. Norris, 6/1,6/4. Women's Doubles—Miss Gams and Miss Jones d. Mrs. Norris and Miss Morris, 8/6,6/2. Mixed Doubles—Miss Gams and Perry d. Mrs. Van Tassel and Hutchison, 6/4,3/6,6/4. Boys' Singles—J. L. Zemon d. Alan Devine, 6/2,3/6,6/2,2/6,6/3. Boys' Doubles—Sidney Israel and Louis Frank d. M. Divine and W. Alfred, 6/1,6/1,6/1. Junior Singles—George Reindel, Jr., d. Paul Jerome, 5/4,6/3,6/1. Junior Doubles—E. Tait and H. Harris d. Hartwig and Hoenke, 6/4,3/6,2/6,7/5,9/7. Girls' Singles—Audrine Jones d. L. Morris, 6/3,6/1,6/2.

Detroit tennis was strongly represented in the war, about forty members of the Tennis Club being in various branches of the service, besides numerous players outside the club. Among the well known players who were in active service were S. L. Ferguson, parks champion, who was wearing a navy uniform at the time he took the title; James Shields, runner-up in 1917 parks tournament; P. J. Donovan, R. G. Owen, former city champion; Ira H. Reindel, John Codd and Theodore Lightner. Donovan, Owen and Reindel were overseas.

## Michigan State Championships

The Michigan State event, held in August, called out a fair-sized entry, but despite the presence of four fine players from Ohio, there was no one on hand who could take a set from Westbrook. In fact, Detroit "froze out" the outsiders

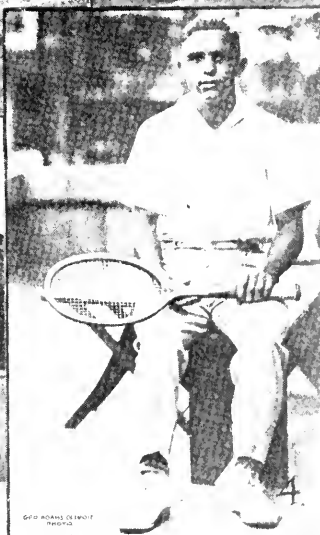
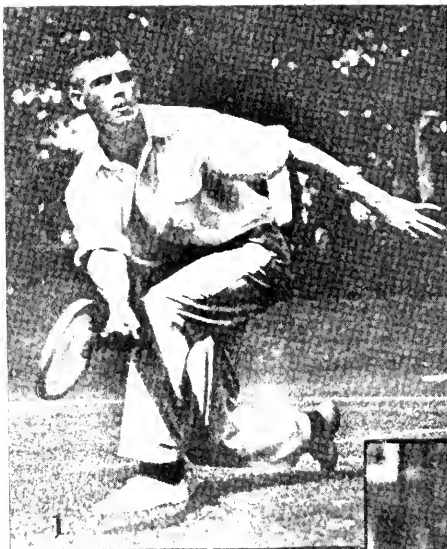

1. John McGee, St. Paul City Champion. 2. Howard Penfold, Kansas City Champion. 3. Phil Brain, Minneapolis; Western Canada Doubles Champion. 4. Walter Westbrook, Harvard University; New England, Michigan State and Detroit City Champion.

altogether in the finals, Carl Raseman having disposed of Henry Wick of Cleveland in straight sets in the semi-finals, while Westbrook was beating Gordon Minor the same way. In the earlier rounds, Raseman had defeated H. W. Hane of Marion, Ohio, a youngster who gives much promise, and Wick had eliminated his fellow-Cleveland, Vinton Vernon, who is also a comer, to all appearances.

In the men's doubles, the Ohioans swept the boards, and Hane and Vernon won the title by disposing of Wick and Minor in the final. The doubles play was not especially good, though Hane and Vernon had some streaks that were high class.

Miss Buda Stephens of Detroit took the women's singles title, defeating Miss Emily Stark of Adrian in the final. Miss Bobbie Esch and Miss Ruth Wise of Cleveland were eliminated by the Misses Stark and Stephens, respectively, in the semi-finals. The women's doubles was won by Miss Stephens and Mrs. F. J. Loewe from the Misses Wise and Esch in a nice match, 7/5,7/5, in the final round. The mixed doubles furnished close competition, Miss Stephens and Westbrook finally winning out.

#### MEN'S SINGLES.

**FIRST ROUND**—Charles Merkel d. Ray Monahan, 11/9,0/6,8/6; T. T. Fautleroy d. Francis Tait, 6/1,9/7; R. H. Browne d. F. A. Shaw, 6/3,6/2; G. C. Meyer d. George Reindel, Jr., 7/5,6/2; J. B. Lee d. Paul Leidy, 11/9,6/1; Nicolas Garcia d. Harry Knox, 11/9,6/1; Robert Burns d. S. H. Small, 6/1,6/4; H. W. Hane d. J. A. Morse, 7/5,6/3; W. B. Lewis d. F. Y. O'Brien, 6/2,6/4; Lewis Munz d. J. Shirk, 6/1,6/4. **SECOND ROUND**—John Houswood d. Julien Zemon, 6/2,5/7,6/1; A. L. Rose d. L. R. Hayes, 3/6,8/6,7/5; F. H. Floyd d. Edward Hess, 6/1,6/1; Merkel d. Paul Jerome, 7/5,7/5; Westbrook d. Fautleroy, 6/0,6/2; Browne d. Meyer, 6/3,6/4; Garcia d. Lee, 6/4,6/4; Hane d. Burns, 6/3,7/5; Munz d. Lewis, 4/6,7/5,6/3; Carl Raseman d. Dean Emerson, 6/2,6/3; Vinton Vernon d. H. F. Prescott, 7/5,6/1; Henry Wick, Jr., d. W. Stearns, 6/2,6/1; L. Montgomery d. R. J. Emmett, 6/4,4/6,6/4. **THIRD ROUND**—Rose d. Houswood, 8/6,5/7,7/5; Minor d. T. C. Rice-Wray, 9/7,8/6; Floyd d. Merkel, 6/1,7/5; Westbrook d. Browne, 6/2,6/3; Hane d. Garcia, 6/2,6/3; Raseman d. Munz, 6/1,8/6; Wick d. Vernon, 6/3,6/4; Montgomery d. Swan, 6/4,7/5. **FOURTH ROUND**—Minor d. Rose, 6/2,6/4; Westbrook d. Floyd, 6/2,6/3; Raseman d. Hane, 7/5,4/6,7/5; Wick d. Montgomery, 6/1,6/3. **SEMI-FINAL ROUND**—Westbrook d. Minor, 6/3,6/4,6/3; Raseman d. Wick, 6/3,6/2,6/3. **FINAL ROUND**—Walter Westbrook d. Carl Raseman, 6/0,6/3,6/3.

#### MEN'S DOUBLES.

**FIRST ROUND**—Emmett and G. Hartwig d. Hess and Browne, 4/6,6/4,6/4; Hane and Vernon d. Rice-Wray and Slack, 6/2,6/4; Garcia and Lewis d. Lee and S. B. Seay, 6/4, 6/7,6/4; Meyermann and Fautleroy d. Leidy and Corey, 2/6,6/4,6/4; Raseman and Munz d. Burns and Montgomery, 6/4,4/6,6/2; Wick and Minor d. Blair and Lewis, 6/0,6/2; Westbrook and Emerson d. Tait and Fitzgerald, 6/2,6/0; Brick and Knox d. O'Brien and Ferguson, 7/5,6/4. **SECOND ROUND**—Hane and Vernon d. Emmett and Hartwig, 7/5, 6/3; Garcia and Lewis d. Meyer and Fautleroy, 0/6,6/1,6/4; Wick and Minor d. Raseman and Munz, 6/2,7/5; Westbrook and Emerson d. Brick and Ferguson, 6/3,6/1. **SEMI-FINAL ROUND**—Hane and Vernon d. Garcia and Lewis, 6/2,4/6,1/6,8/6,6/3; Wick and Minor d. Westbrook and Emerson, 6/8,6/4,6/3,7/5. **FINAL ROUND**—H. W. Hane and Vinton Vernon d. Henry Wick, Jr., and Gordon Minor, 5/7,6/1,6/1,6/3.

#### WOMEN'S SINGLES.

**FIRST ROUND**—Miss Ruth Wise d. Mrs. Bentley, 6/1,6/3; Miss Marion Gambs d. Miss Kathleen Codd, 6/2,6/4; Miss Emily Stark d. Mrs. Thiebolt, 6/0,6/1; Mrs. A. J. Norris d. Mrs. F. J. Loewe, 6/3,6/3; Miss Bobbie Esch d. Mrs. C. W. Thomas, 6/2,6/0. **SECOND ROUND**—Miss Buda Stephens d. Miss M. M. Stocker, 6/3,6/1; Miss Wise d. Miss Gambs, 6/3,6/2; Miss Stark d. Mrs. Norris, 6/3,8/6; Miss Esch d. Mrs. Van Tassel, 6/1,6/1. **SEMI-FINAL ROUND**—Miss Stephens d. Miss Wise, 6/3,8/6; Miss Stark d. Miss Esch, 6/3,8/6. **FINAL ROUND**—Miss Buda Stephens d. Miss Emily Stark, 6/4,6/2.

#### WOMEN'S DOUBLES.

**FIRST ROUND**—Miss Ruth Wise and Miss Bobbie Esch d. Miss Kathleen Codd and Miss Muriel Westbrook, 6/0,6/1; Miss Buda Stephens and Mrs. F. J. Loewe d. Miss M. M. Stocker and Mrs. C. W. Thomas, 6/1,6/4. **SEMI-FINAL ROUND**—Miss Wise and Miss Esch d. Miss Emily Stark and Mrs. Bentley, 6/4,6/1; Miss Stephens and Mrs. Loewe d. Miss Marion Gambs and Miss Audrine Jones, 6/2,6/2. **FINAL ROUND**—Miss Buda Stephens and Mrs. F. J. Loewe d. Miss Ruth Wise and Miss Bobbie Esch, 7/5,7/5.



1. R. B. Roehr, President Milwaukee Tennis Association; 2. Bert Thelen, Milwaukee County Champion; M.T.A. Champion; 3. Louis Rechcygl, M.T.A. Doubles Champion; 4. Elmer Lipman, Milwaukee Doubles Champion; 5. Ben Arndt, Runner-up M.T.A. Doubles; 6. Harold Amos, Runner-up M.T.A. Doubles; 7. Howard Schuler; 8. Walter Stuckert; 9. Froeming; 10. H. Hieken.

GROUP OF ACTIVE MEMBERS OF THE WASHINGTON PARK TENNIS CLUB, MILWAUKEE, WIS.

## Lawn Tennis in Milwaukee

BY R. B. ROEHR, PRESIDENT MILWAUKEE TENNIS ASSOCIATION.

The season of 1918 was one of the most successful in the history of the Milwaukee Tennis Association. This is true not only from the standpoint of increased competition and in spite of the fact that quite a number of players were drawn into the service as a result of the various draft calls, but also from the standpoint of the quality of play that was exhibited.

Two tournaments were held, one an innovation in tennis affairs of Milwaukee County, namely, the boys' junior tournament, which was held during the week of June 24, and the other, the county championship, was held during the week of July 15.

The boys' junior tournament was a decided success and will doubtless become a permanent fixture so far as local county tennis affairs are concerned.

The tournaments were of particular significance to the association and to followers of tennis in Milwaukee County and elsewhere in the State of Wisconsin, for the reason that practically, for the first time in the history of Milwaukee Tennis Association affairs, these tournaments were given official recognition by the United States National Lawn Tennis Association, by reason of the Milwaukee Association being a member of the Western Association.

Although there was not a very large entry in the boys' junior tournament, this was due to several reasons. The competition was limited to boys under nineteen years of age. At the time the tournament was held, a great number of eligible boys had already departed for their summer vacations. Then, too, the tournament being an entirely new one, there were any number of boys who held back because of lack of experience and an inclination to doubt their ability to put up a good game.

The final match brought out a splendid exhibition between Benny Arndt and Tony Hollender, being finally won by the latter after a gruelling contest. Hollender's superior staying qualities and general all-around play is what won for him. He also exercised fine judgment in his change of plays, taking advantage, particularly during the last three sets, of every weakness that was exhibited by Arndt. The beautiful medal awarded Hollender by the United States National Lawn Tennis Association was greatly appreciated by the winner.

The county championship tournament also was a success, though there were not as many entries as had been anticipated; but the quality of play more than made up for the lack of entries.

Bert Thelen, veteran of a dozen years of tennis and winner of a score of trophies, surpassed all Milwaukee followers of the net game in his feat of winning the singles championship. Thelen's class and play was primarily the outstanding feature. He met upwards of half a dozen of the best players within Milwaukee County and defeated all of them decisively. He did the same thing in the elimination contest for the singles championship of the Milwaukee Tennis Association proper. Thelen is the proud possessor of both titles for the year 1918 and, with particular reference to the elimination contest within the association itself, his win gives him two chances on the President's Cup. In order to become the permanent possessor, it is necessary for a contestant to win three times, not necessarily in succession.

Naturally, as a result of his prowess, Thelen secures the undisputed rank of No. 1, so far as Milwaukee County players are concerned. Although it will be

said that some good men were in the service, the fact remains that among "good men" must be placed the name of Louis Rechcygl, former city champion, who went to defeat before Thelen in the deciding match for the Washington Park Tennis Club title. In second position should be placed Elmer Lipman, the fleet-footed Washington Park man, whose work in the team contests aided his club considerably. He also played well in all tournaments. It is claimed that Lipman makes one of the best doubles partners in the State.

There is just a bit of doubt regarding the selection of the next four players, although Rechcygl is given the third position. The fact remains that Arndt, Effler and Hollender equaled the exhibitions of Rechcygl in 1918, though, of course, past performances naturally would reflect to some extent on the rankings in a case of this kind. Benny Arndt played great tennis, as did Hollender. Net followers know how the Washington Park player lost to Hollender in the junior championship, only to trim Hollender later in the season. A bit of misfortune held back Harry Effler, for, after reaching the final in the county championship, only to fall before Thelen, he also relinquished his hold on the Milwaukee Tennis Association laurels.

In speaking of Hollender it might be stated that he is one of the local players who has a future at the tennis game. Young as he is, he almost ranks with the best. Nick Aagesen gets a position because of his good work in the team matches, while Amos is ranked ninth for winning the county doubles honors, with Louis Rechcygl as partner. Cherrington is included in the list because of his work in the county tournament. There are others—players who were in the service—who deserve a position, but they played too little to be considered. These are Wallie Stuckert and Ray Loew of the Washington and National Tennis Clubs, respectively.

Summary of Milwaukee Tennis Association matches follows:

#### MEN'S SINGLES.

FIRST ROUND—Arndt d. Effler, 6/3,4/6,8/6; Lipman d. Kirchner, 6/1,7/5; Aagesen d. Amos, 6/3,6/0; Crawford d. Pollock, 6/1,8/6. SECOND ROUND—Arndt d. Hollender, 6/2, 6/2; Lipman d. Reitman, 6/2,6/3; Rechcygl d. Aagesen, 6/2,6/4; Thelen d. Crawford, 6/1, 6/3. SEMI-FINAL ROUND—Lipman d. Arndt, 6/2,6/0,3/6,6/2; Thelen d. Rechcygl, 4/6, 5/7,6/4. FINAL ROUND—Thelen d. Lipman, 6/4,6/2,8/6.

#### MEN'S DOUBLES.

FIRST ROUND—Lipman and Rechcygl d. Waite and Paine, 6/0,6/3; Thelen and Patne d. Miller and Schuler, 6/4,6/1; Amos and Arndt d. Aagesen and Kirchner, 7/5,6/3; Pierick and Pierick d. Effler and Crawford, 6/2,3/6,6/3. SEMI-FINAL ROUND—Rechcygl and Lipman d. Thelen and Paine, 10/8,4/6,3/6,6/2,6/2; Amos and Arndt d. Pierick and Pierick, 6/3,8/6,6/3. FINAL ROUND—Lipman and Rechcygl d. Amos and Arndt, 7/5,3/6,6/3,11/9.

## Tennis in St. Louis

BY ROBERT ROSS.

The junior preliminary tennis center championship was held on the courts of the Triple A and sixteen youngsters aspired to the honor, some excellent tennis resulting. Nearly every match went the three sets, and should the youngsters practice and study the game, St. Louis may yet possess a national champion. Val Satterfield and Clyde Baessler reached the final round, Satterfield winning in straight sets, 6/4,6/3,6/4.

The Municipal Association also held a center championship, which was won by Wray Brown. The finals were played on the Triple A courts, Brown winning the honor of going East to the national junior championship.



In the boys' preliminary, fourteen entries were received, some very good tennis resulting. Howard Gould and Stockton Sommer reached the final round, Sommer winning out in a hard four-set match, 6/2,4/6,6/4,6/2.

The winner of the boys' tournament, held by the Municipal Association, was Richard Rosebrough, who was to play Sommer, but the latter was obliged to leave for college and defaulted to Rosebrough in the final round.

In the city championship, seventy-four players entered, and the good effects of holding junior tournaments became apparent. Most of the juniors who played in the earlier tournament entered the men's championship and gave some of the older players a hard fight, some of the latter even going down to defeat before the youngsters.

Theodore Drewes, the 1917 champion, won his way to the final by defeating the following players: J. H. Flachsbarth, W. Smith, Ed Serrano, H. S. Cushman and Rae Hollinshead. In the lower half, the seventeen-year-old junior, Vray Brown, was eliminating all players in his path. In the semi-finals he met Satterfield, another junior and had a rather easy victory, 6/3,6/0,6/0.

In the final round against Theodore Drewes, Brown was seemingly off his game, as he should have made a much better showing against the champion than he did, although Drewes was playing championship tennis that afternoon.

In the doubles, sixteen teams entered, the older players successfully reaching the finals. Drewes and Von Reppert in the upper half met Jones and Hoerr, the former pair winning in a hard four-set match, 5/7,6/2,6/4,8/6.

The city championship for women was held on September 24 and was won by Miss Gould, who defeated Mrs. H. S. Adams in the finals. In the doubles, Miss Gould was paired with Mrs. Adams and met Miss Hagemeyer and Miss Roever in the final round. It was expected that the former pair would have no trouble in winning, but their opponents put up a surprisingly good game. Although defeated, Miss Hagemeyer and Miss Roever with a little more tournament experience will have much to say in deciding future city doubles championships. The score was 6/4,9/7.

The junior city championship was held by the Triple A with an entry of twenty-five players, and the play showed a vast improvement over that of the earlier tournament. Dan Diesel in the first round defeated R. Rosebrough, 4/6,6/3,6/3. In the second he disposed of D. Hilkenbaumer, 12/14,6/3,6/3, while in the semi-finals he won from Roy Blienkamp, 6/1,6/3,6/3. In the lower half, George Pasmore defeated R. Jordan, 6/4,6/3; H. Gould, 6/0,6/3; A. Reiman, 6/4,6/1, and R. Fowler in the semi-finals, 6/1,6/3,5/7,6/3. In the final round Diesel won out after a five-set match, 4/6,7/5,6/4,8/6,6/4. In the final round of the doubles, Diesel and Blienkamp won, defeating Drewes and Pasmore, 10/8,6/2,3/6,6/4.

The Municipal Association, as is its custom, held a tournament in each park, the winners of each division playing off for the championship of the association. Every division had a large entry, although they also felt the effects of the war. The winners of the different divisions were as follows:

**Singles**—Leo Moulton, Carondelet Park; Charles M. Borne, St. Louis Park; Elmer Schwarz, Forest Park; Theodore Drewes, Fairground Park; Fred Josies, O'Fallon Park. Theodore R. Drewes was the winner in final play-off.

**Doubles**—Moulton and Walberg, Carondelet Park; Borne and Koenneman, St. Louis Park; Schwarz and Schwarz, Forest Park; Drewes and Niemoeller, Fairground Park. Drewes and Niemoeller were the winners in finals.

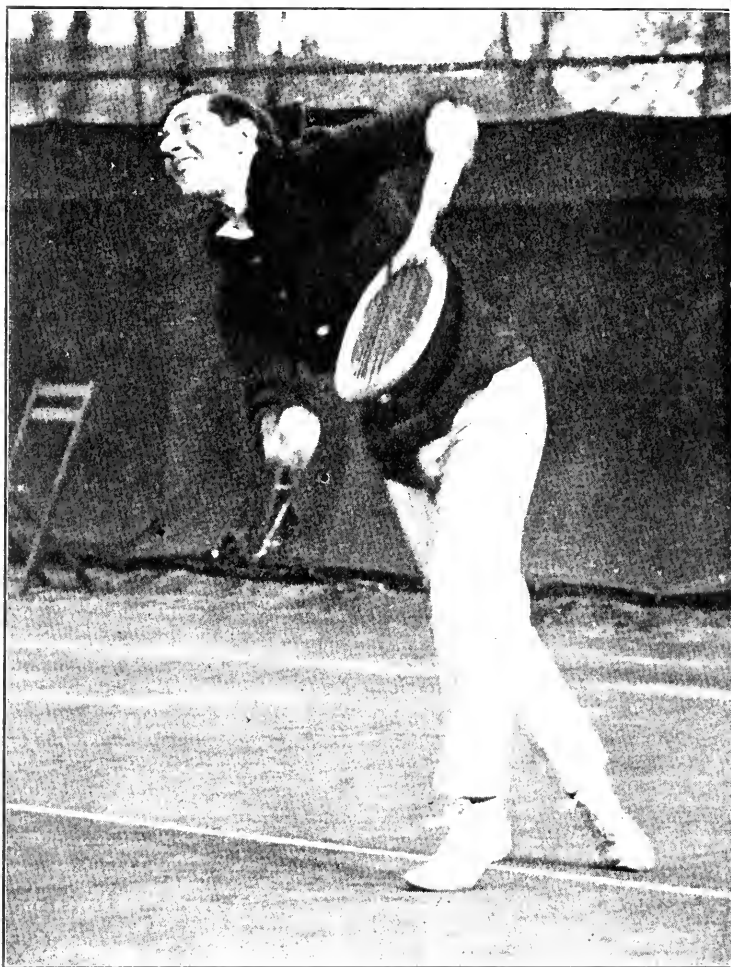

S. HOWARD VOSHELL,  
Brooklyn, N. Y.  
Central States Champion.

## Central States Championships

BY ROBERT ROSS.

The Central States championships were held under the auspices of the St. Louis Amateur Athletic Association—Triple A Club—on July 6, with an entry list of forty-eight players in the men's singles. Although the war made a heavy inroad on the entry list, it was the means of making the 1918 championship one of the most interesting from the viewpoint of the tennis fan, as it gave to the tournament S. Howard Voshell and Craig Biddle, who were at Cott Field, Ill., in the flying service.

In the first round Voshell met the young player, W. G. Drozda, and disposed of him rather easily. In the second round he met another youngster, Wray Brown, who represented the club in the national junior championships. Wray was naturally a little excited in the first set, which Voshell placed to his credit 6/3; but in the second, Voshell had to extend himself, the set going to 7/5, and most of the games were deuced several times. The next in his path was Fred Josties of Municipal fame, but the latter did not put up the tennis expected of him and went down to defeat. In the semi-finals, Voshell met Ted Drewes, holder of the 1917 championship, but the steady smashing game of Voshell won out in a hard match.

While Voshell was fighting his way through in the upper half, his partner, Craig Biddle, was pushing all opposition aside in the lower half. In the first round he defeated Dr. F. Diekneite; in the second, N. P. Gautier; in the third, W. R. Schneider; while in the fourth he met some opposition from E. A. Schwarz, the score being 6-4, 6-3. The semi-finals found him opposed to Roland Hoerr, who has two legs on the trophy and only needs another to gain permanent possession. On him the St. Louis fans pinned their faith to keep the big cup from going to the Eastern players, but they were due for a disappointment, as the fast smashing game of Biddle was too much for the local favorite.

On Saturday, when the final was played, every inch of space around the championship court from where a play could be seen was occupied, and the spectators were rewarded with as fine a display of tennis as ever was seen on the courts. The first set went to Biddle, 6-4, and was fast tennis from start to finish. In the next set Biddle seemed to tire and the gallery began to think that it was all over, Voshell taking the set, 6-1. In the third set Biddle did better, securing three games. The fourth long will be remembered by those who had the pleasure of witnessing it, the games seesawing from one to the other, most games going to deuce repeatedly and both players making almost impossible plays; but the steady smashing of Voshell finally won out with the score 9/7. Kumagai has a leg on the trophy and St. Louis fans are hoping, now that the war is over, that he and Voshell will be here in 1919 to try to place their names on the cup for the second time.

In the Central doubles, seventeen teams entered, Voshell pairing with Biddle. J. B. Adoue and George Wright of Texas entered, but at the last minute business interfered with their making the trip. Voshell and Biddle met Hilton and Eichmeier in the first round and disposed of them, 6/1, 6/2. In the second they met Wray Brown and Dr. Carson. The fans expected a hard match, but were disappointed, the army men winning, 6/1, 6/1. In the semi-finals they met Drewes and Josties, the local stars, in a match producing both good and bad



CRAIG BIDDLE,  
Philadelphia.

tennis. The first two sets went to Voshell and Biddle, 6/1,6/4, the spectators coming to the conclusion that the doubles championship was also to go to the Eastern players. But in the third set the youngsters began to hit their stride and took the set at 6/4, and the fourth also by the same score.

It was now two-sets-all and both teams settled down to hard work. Some fine tennis was displayed by each player, Voshell and Drewes playing the "take-a-chance game" when opportunity offered, while Josties and Biddle were content to play a safe, steady game. The games were evened up alternately until the score came to 5-all, when the youngsters took the next two games and the match. The spectators, of whom there were several thousand, applauded the good plays of each side; but when they realized that the home youngsters had won they rose in a body and gave three rousing cheers for the winners, in which they were joined by the delegation of about one hundred flyers from Scott Field. Voshell and Biddle will always have a warm spot in the hearts of the St. Louis players, who earnestly desire their return this year.

#### MEN'S SINGLES.

FIRST ROUND—George Pasmore d. D. Morton, 6/2,6/4; H. M. Hess d. T. M. Corwin, 6/4,6/2; F. O. Josties d. A. Baron, 6/0,6/1; George T. Johnson d. J. R. Goodwin, 6/2,6/0; W. G. Drozda d. C. O. Gilbert, 6/1,6/2; S. H. Voshell d. C. C. Griffith, 6/0,6/2; Wray Brown d. C. Hilton, 6/0,6/0; W. R. Schneider d. Gordon Fennell, 6/2,6/3; C. D. P. Hamilton d. C. D. Jones, 6/3,6/2; H. P. Gautier d. R. A. Epstein, 6/1,6/3; Craig Biddle d. F. Dickneite, 6/2,6/1; H. E. Bryant d. E. Henermann, 6/0,6/1; H. S. Cushman d. T. G. Norton, 6/2,6/3; E. A. Schwarz d. W. Heckemeyer, 6/2,6/1; Davison Obeur d. A. Haerting, 6/3,6/1. SECOND ROUND—H. R. Hollingshead d. C. M. Frazier, 6/4,4/6,6/2; Dr. Carson d. A. Loud, 6/4,1/6,8/6; Theodore Drewes d. C. H. Borne, 6/4,6/1; Pasmore d. Hess, 4/6, 6/4,6/1; Josties d. Johnston, 6/2,6/2; Voshell d. Drozda, 6/1,6/0; Brown d. H. Eichmeier, 6/0,6/0; Schneider d. Hamilton, 3/6,7/5,6/4; Biddle d. Gautier, 6/1,6/0; Bryant d. Cushman, 6/3,7/5; Schwarz d. Obeur, 8/6,6/8,6/2; R. M. Hoerr d. W. A. Bankey, 6/0,6/3; G. F. Brocker d. G. H. Rice, 6/2,6/1; J. W. Charles d. A. Reiman, 7/5,6/2. THIRD ROUND—Hollingshead d. C. H. Albers, 6/4,6/3; Drewes d. Carson, 6/3,6/1; Josties d. Pasmore, 6/0,6/0; Voshell d. Brown, 6/1,6/0; Biddle d. Schneider, 6/1,6/1; Schwarz d. Bryant, 6/2, 7/5; Hoerr d. Brocker, 6/4,6/1; Satterfield d. Charles, 6/1,6/2. FOURTH ROUND—Drewes d. Hollingshead, 6/4,6/2; Voshell d. Josties, 6/1,6/4; Biddle d. Schwarz, 6/4,6/1; Hoerr d. Satterfield, 6/1,6/2. SEMI-FINAL ROUND—Voshell d. Drewes, 6/3,6/4,6/3; Biddle d. Hoerr, 6/2,5/7,6/4,6/1. FINAL ROUND—S. H. Voshell d. Craig Biddle, 4/6,6/1,6/3,9/7.

#### MEN'S DOUBLES.

FIRST ROUND—Biddle and Voshell d. Hilton and Eichmeier, 6/1,6/3; Brown and Carson d. Pasmore and Fennell, 6/4,6/2; Hollingshead and C. Placke d. Cushman and Hess, 6/7,6/4,6/4; Drewes and Josties d. Rice and Haerting, 6/2,6/1; A. Von Reppert and Schwarz d. Albers and Johnson, 6/0,6/3; Obeur and Oya d. Bryant and Sullivan, 7/5,6/3; Jones and Hoerr d. Charles and Frazier, 6/2,6/3. SECOND ROUND—Biddle and Voshell d. Brown and Carson, 6/1,6/1; Drewes and Josties d. Hollingshead and Placke, 6/3,6/4; Von Reppert and Schwarz d. Satterfield and Henermann, 6/2,6/3; Jones and Hoerr d. Obeur and Oya, 6/0,6/1. SEMI-FINAL ROUND—Drewes and Josties d. Biddle and Voshell, 1/6,2/6,6/4,6/4,7/5; Jones and Hoerr d. Von Reppert and Schwarz, 6/4,1/6,8/6,6/4. FINAL ROUND—Theodore Drewes and Fred O. Josties d. C. Drummond Jones and Roland M. Hoerr, 6/4,8/6,4/6,8/10,6/3.

## Central States Women's Championships

By ROBERT ROSS.

The women's Central championship also felt the effects of war service, most of the players doing Red Cross work. Only twenty entries were secured, and the majority played their matches while off duty. Mrs. A. Yager (now Mrs. Rameson) of Los Angeles, in the first round defeated Miss Helen Dyer, 6/0, 6/0, and in the second Miss N. Burgee, 6/2,6/0. In the third round she met with some opposition from Miss Etta Roeber, the score being 6/4,6/3.



1. Sgt. Davison Oheir, Secretary St. Louis Tennis Association; 2. John W. Adams, Jr., Northwestern Doubles Champion; St. Paul Doubles Champion. 3. Theodore R. Drewes, Missouri State Champion in singles and doubles; St. Louis City Champion. GROUP AT MONTANA STATE CHAMPIONSHIPS— 4. Howard Robinson, Doubles Champion; 5. L. F. Haley, Secretary-Treasurer Montana Tennis Association; 6. Kenneth Simmons, winner of four championships at tournament; 7. Dr. Karsted, President Montana Tennis Association.

In the lower bracket, Miss Corinne Gould, the seventeen-year-old local player, who holds the State and city championships, was working her way to the finals. In the preliminary round she met the former State and city champion, Miss Arnstein, who later on served the Red Cross in France. Miss Arnstein put up a good fight, the score being 6 4/6/3. In the second round she defeated Miss M. Haase, 6 1/6 1; in the third round, Mrs. H. S. Adams of Centralia, Ill., by the same score; in the fourth she defeated Miss F. Mabley, 6 1/6/2, and met Mrs. Yager in the final round. Mrs. Yager was the favorite, but the match was a pleasant surprise to the many admirers of Miss Gould's play. She took the match rather easily, 6 2/7 5, Mrs. Yager displaying some fine tennis in the last set, but the accurate fast serve and steady placing of Miss Gould could not be overcome.

In the women's doubles, Mrs. Yager and Miss Gould paired and had no difficulty in winning, the only hard match being in the second round, where they defeated Mrs. Adams and Miss Arnstein, 6 3/9 7. In the mixed doubles, Davison Obeare and Mrs. Yager met E. Schwarz and Mrs. Adams in the final round, the latter winning after a hard three-set match, 3 6/6 3/6 4.

#### WOMEN'S SINGLES.

FIRST ROUND—Miss Etta Roever d. Miss Mary Harris, 6 8/6 3/8 6; Miss Corinne Gould d. Miss N. Arnstein, 6/4,6/3; Miss M. Haase d. Miss M. Kronsbein, 6 2/6 3. SECOND ROUND—Miss Norma Burger d. Miss M. Finnegan, 10 8/7/5; Mrs. Adelaide Yager d. Miss Helen Dyer, 6/9,6/9; Miss A. C. Henske d. Miss Elma Drewes, 6 4/6/4; Miss Gould d. Miss M. Haase, 6 1/6/1; Miss Frances Mabley d. Miss Louise Luedeking, 6/2,6 2. THIRD ROUND—Mrs. Yager d. Miss Burger, 6 2/6 9; Miss Roever d. Miss Henske, 6-4, 7/5; Miss Gould d. Mrs. S. H. Adams, 6 1/6 9; Miss Mabley d. Dr. O. Stricker by default. SEMI-FINAL ROUND—Mrs. Yager d. Miss Roever, 6 1/6 3; Miss Gould d. Miss Mabley, 6 1/6 2. FINAL ROUND—Miss Corinne Gould d. Mrs. Adelaide Yager, 6 2/7 5.

#### WOMEN'S DOUBLES.

FIRST ROUND—Miss Henske and Dr. Stricker d. Miss Mabley and Miss E. Johnston, 6/1,6/9. SECOND ROUND—Miss M. Haase and Miss Finnegan d. Miss Adele Dubuque and Miss Genevieve Dubuque, 6 2/7/5; Mrs. Yager and Miss Gould d. Mrs. Adams and Miss N. Arnstein, 6/3,9/7; Miss Henske and Dr. Stricker d. Miss E. Miller and Miss G. Stevenson by default; Miss Alice Drewes and Miss Roever d. Miss L. Luedeking and Miss M. Kronsbein, 6 1/6 9. SEMI-FINAL ROUND—Mrs. Yager and Miss Gould d. Miss Haase and Miss Finnegan, 6 1/6 3; Miss Henske and Dr. Stricker d. Miss Drewes and Miss Roever, 6 2/6 3. FINAL ROUND—Mrs. A. Yager and Miss Corinne Gould d. Miss A. C. Henske and Dr. O. Stricker, 6/2,6/3.

MIXED DOUBLES: Final Round—Miss H. S. Adams and E. A. Schwarz d. Mrs. A. Yager and Davison Obeare, 3,6,6 3,6/4.

## St. Louis Tennis Association

BY DAVISON OBEAR, SECRETARY.

When the St. Louis Lawn Tennis Association held its first meeting of the 1918 season, the fact that we were in the war had begun to show its effect by the absence of a number of prominent players, and the prospects for a successful year were far from promising. However, the officers canvassed the local situation, and at the June meeting the membership showed an increase over 1917.

The five park clubs held an interclub tournament throughout the summer under the direction of the Municipal Tennis Association, and seven of the remaining eight clubs also held an interclub series under the supervision of the St. Louis Tennis Association. The O'Fallon Park Club won the municipal championship, while the Magnolia Tennis Club was victorious in the St. Louis Tennis Association event. In the play-off for the city championship, the O'Fal-

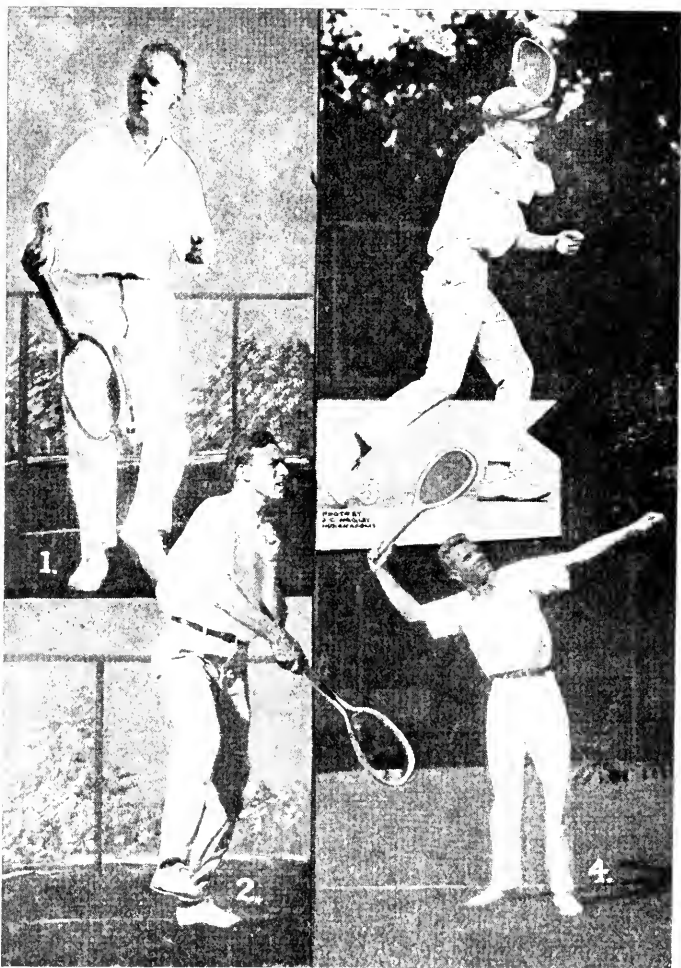

1. Don Harker, Colorado State Singles and Doubles Champion. 2. E. R. Bailey, Colorado State Doubles Champion. 3. John Hennessey, Indiana State Champion; Runner up National Junior Championship. 4. Arthur Hubbell, Chicago Suburban Champion.



lon Parks won the title, taking all three matches from Magnolia. The standing of the clubs follows:

| MUNICIPAL TENNIS ASSOCIATION. |      |       | ST. LOUIS TENNIS ASSOCIATION. |      |       |
|-------------------------------|------|-------|-------------------------------|------|-------|
|                               | Won. | Lost. |                               | Won. | Lost. |
| O'Fallon Park .....           | 4    | 0     | Magnolia .....                | 6    | 0     |
| Fairground Park .....         | 3    | 1     | Wagner .....                  | 4    | 1     |
| Forest Park .....             | 2    | 2     | Wabash .....                  | 4    | 1     |
| Carondelet Park .....         | 1    | 3     | Y.M.H.A. ....                 | 2    | 3     |
| St. Louis Park.....           | 0    | 4     | Westwood .....                | 1    | 3     |
|                               |      |       | Plumb .....                   | 0    | 4     |
|                               |      |       | Leschen .....                 | 0    | 2     |

In the play-off for the city championship the O'Fallon Park Tennis Club defeated the Magnolia Tennis Club team, 3 to 0. Several clubs were forced to default their matches on account of their players going into the service. Despite the war conditions the season was a successful one, as five more clubs took part in the play than in 1917.

Owing to the influenza epidemic, the second annual meeting was postponed until February 6, 1919. At this time nearly all of the prominent officials of the various clubs who had been in the service returned to the city. The following officers for 1919 were elected: Honorary president, Major Dwight F. Davis; president, Calvin P. Bascom; vice-president, Moe D. Levy; secretary, Davison Obear; treasurer, Dr. George H. Rice. Reports of the past season's activities were made, and the O'Fallon Park team was presented with a handsome banner for winning the championship. Many ideas were brought forth by the delegates, one of vital importance being put into effect. This was the establishment of weekly luncheons to be held every Thursday. Three of these have already been held and are proving extremely valuable. At the April meeting more definite steps will be taken as to the plans for the coming season.

The active workers in the St. Louis Tennis Association wish to make it a clearing house for tennis in every nook and corner of the city. Honesty and fair play is one of the principal policies of the organization, and the newspapers have recognized this fact time and time again, as evidenced by their most generous support. Every possible effort is made to conform to the wishes of the United States National Lawn Tennis Association and the Western Lawn Tennis Association in the furtherance of not only local but national interest in what many consider here the greatest of all games—tennis.

## Tennis in Kansas City

By C. E. McBRIDE.

The tennis ranks of the Kansas City clubs—Rockhill, the Field Club, the Kansas City Athletic Club, and even the numerous neighborhood clubs—were depleted probably more than any other branch of sport by players entering the war service.

The Rockhill Club, Kansas City's exclusive tennis club and one of the best equipped in the country, lost one hundred members, one-third of its membership. However, a fine tribute to this club is the fact that the finances were in such condition that, despite the loss of members, the club went through the summer and winter without an assessment against the remaining members, and is making unusual preparations for taking back the old members as they return

from the service and for tournaments in the summer of 1919. The Rockhill Club now has fourteen of the finest clay and grit courts in the country and plans are under way to build seven more, the ground being adequate for that number.

Always may it be said of the tennis clubs in Kansas City, not only those of the private clubs but the one hundred public courts as well, that they gave their best to the country in the war, and at the same time made a fine attempt at "carrying on" at home while their members were training in this country or in the fighting forces abroad.

The Kansas City Athletic Club passed up its annual Missouri Valley tournament, probably the best known of the big Valley tournaments; but Rockhill and the Field Club held patriotic tournaments and the players of all the clubs took part in a renewal of the city tournament, playing the matches on the various club courts.

Charles Howard Mills, Recreation Supervisor, also played a part in keeping something doing for the tennis folks at home, devoting his efforts to the players who use the public courts. A gigantic tournament was held and a fine interest shown by the public court players.

Howard Penfold, a youth, defeated Heath Moore, a veteran of many a hard fought tournament match, in the final of the city tournament, played on the field of the Kansas City Athletic Club in June. Ernie Primm beat Soldanels in the final of the city junior tournament on the Field Club courts, also held in June.

The annual Missouri State tournament, held on the Field Club courts in August, found Ted Drewes, the youthful St. Louisan, coming into his own, by defeating C. T. Speice, an Oklahoman, in the final. Drewes and Niemoeller won from Simmons and Durall in the doubles.

A mixed doubles tournament was played on the Field Club courts in September, Ernie Primm and Miss Mary Morley winning from L. T. Shonnard and Miss Marjorie Hires in the final. Miss Morley was a victim of the epidemic of Spanish influenza the following November. She was one of the veteran women players of Kansas City and will be missed in tennis circles of the city.

The Municipal tournament ran on the city courts through August and September. Solden Els won the men's singles and Joe Jackson the boys' singles. Miss Margaret Donovan won the women's singles and Miss Martha McLendon the girls' singles.

The high school tennis tournament is an interesting event each spring. In 1918 Merrill Dubach of Central won the singles title, Wilson Riley, Northeast, being the runner-up. In the doubles, Deneheim and Reicher, Westport, were defeated by the Dubach brothers, Merrill and Kenneth. Miss Laura Small, Westport, won the singles in the girls' play, Miss Martha McLendon, Central, being the runner-up. Miss Dorothy Kaney and Miss Ruby Euston of Central were the doubles winners.

All of the clubs are making preparations for a big season in the summer of 1919. Captain Cannon and Major Holcomb, Field Club stars and winners of many a Valley tournament, have written from France that they expect to be back and put the speed of some of the younger players to the test.

A list of the members of the Rockhill Club who entered the service will be interesting in that many widely known players are included, and for the further reason that it gives some line on the great showing Kansas City tennis men made in the war work. The list follows:

|                      |                      |                       |                      |
|----------------------|----------------------|-----------------------|----------------------|
| Bagby, P. H.         | Dodson, Ralph        | Kirkwood, I. R.       | Shingleton, J. H.    |
| Bailey, H. R.        | Duffy, Bernard       | Knight, W. H.         | Skinner, Dr. E. H.   |
| Barker, Wm. T.       | Dunham, W. S.        | Krugh, John           | Sloan, J. E.         |
| ★Barnby, John F.     | Everham, A. C.       | Kuhn, Dr. H. P.       | Smelzer, Louis Platt |
| Baucus, Wm. N.       | Eyssell, Erich       | Lacaff, Theo. Bunce   | Smith, G. M., Jr.    |
| Binnie, Dr. J. F.    | Faeth, Gilbert E.    | Lockhorn, C. J.       | Smith, R. Penn.      |
| ★Bland, Wm. T., Jr.  | Farnum, W. C.        | Love, Horace          | Smith, Richard Ode!! |
| Bowersock, Justin D. | Field, Freeman       | Marley, John S.       | Snyder, Jack         |
| Brewen, C. C.        | Finnerty, Robert G.  | Marsh, Ralph E.       | ★Swofford, James J.  |
| Brookfield, A. D.    | Fishback, Frank C.   | Matters, V. C.        | Taft, Willard C.     |
| Brown, David         | Foster, John         | McCune, J. M.         | Teachnor, Dr. F. R.  |
| Brown, R. Francis    | Fulton, A. D.        | Milne, Dr. Lindsey S. | Teuton, L. L.        |
| †Brumback, J. U.     | Gallagher, John      | Morrison, L. P.       | Thacher, John H.     |
| Brumback, Theo.      | Good, Meverell L.    | Morrison, R. T.       | Thompson, Harlan     |
| Butler, Wm. L.       | Grant, M. E.         | Murdock, C. A., Jr.   | Thompson, J. H., Jr. |
| Cameron, W. S.       | Green, M. C.         | Newberry, O. P.       | Timmons, J. K.       |
| Campbell, Dawson     | Gregory, J. V. C.    | O'Keefe, Arthur J.    | Toler, Edw. H.       |
| Capen, Leo L.        | Griffith, E. L.      | Osborne, R. S.        | Tyler, Frank E.      |
| Chafin, Stephen J.   | Hill, Tom C.         | Paulette, Geo. W.     | Walker, John W.      |
| Challinor, J. E.     | Holden, Ellsworth V. | Peer, R. S.           | Walton, R. S.        |
| Chapman, W. B.       | Holmes, J. V.        | Peters, Wm. G.        | Warner, Edward A.    |
| Chin, B.             | Hook, Ingraham D.    | Porter, Pierre        | Warren, F. E.        |
| Clark, Allan C.      | Houghton, James K.   | Poteet, Allen A.      | Wester, R. H.        |
| Collins, R. H.       | Huttig, F. J.        | Randolph, Eston       | Wilson, H. W.        |
| Combs, Geo., Jr.     | Huttig, Hart E.      | Rider, Geo. M.        | Winter, R. Howard    |
| Cross, Wm. J.        | Irwin, Richard D.    | Rule, W. A., Jr.      | Withers, Mary        |
| Cunningham, Paul E.  | Jones, Cale R.       | Sayre, R. B.          | Woodruff, Neal       |
| ★Davis, Murray       | Kem, James P.        | Sears, Kenneth C.     | Wright, John S.      |
| Dobel, J. G.         | Kinney, S. H.        | Schmitz, Walter A.    |                      |
| ★Killed in action.   | †Died in service.    |                       |                      |

## RANKING OF KANSAS CITY PLAYERS.

According to the ranking list prepared by the Kansas City Tennis Association, Heath Moore heads the men players for 1918 and Miss Evelyn Seavey leads the women of that city. The ranking was done on the basis of performance, and no player who had not taken part in at least two tournaments was considered. The ranking follows:

### MEN.

1. Heath Moore, Rockhill Club.
2. Howard Penfold, Rockhill Club.
3. Kenn B. Uhls, Rockhill Club.
4. Ernest Primma, K.C.F.C.
5. Harry E. Bennett, K.C.A.C.
6. H. W. Durall, K.C.F.C.
7. Phil H. Bagby, Rockhill Club.
8. A. H. Dickinson, Rockhill Club.
9. Merrill Dubach, Rockhill Club.
10. William J. Krebs, Rockhill Club.

### WOMEN.

1. Miss Evelyn Seavey, Rockhill Club.
2. Mrs. R. S. Peer, Rockhill Club.
3. Miss Marjorie Hires, Rockhill Club.
4. Miss Mary Morley, K.C.F.C.
5. Miss Louise Hammann, K.C.F.C.
6. Miss M. Chesney, Rockhill Club.
7. Miss Lyle Hayes, Rockhill Club.
8. Miss Ruth Hager, Rockhill Club.
9. Miss M. McLendon, K.C.F.C.
10. Miss G. Pierce, Rockhill Club.

## Great Plains Tournaments

In the annual Great Plains tournament for men, the classic of the Rockhill Club, Heath Moore, president of the club for 1919, played brilliantly throughout the week, coming through a winner in the final against Frank C. Howard, 6/1,6 3,6/4. In the doubles final, Kenneth B. Uhls and Phil H. Bagby defeated B. O. M. Bonebrake and Heath Moore, 6/2,6 3. The summaries:

### MEN'S SINGLES.

FIRST ROUND—Frank Motz d. C. M. Hardenbergh, 6/2,6/0; Arthur Sternberg d. F. E. Wilhelm, 6/4,6/4. SECOND ROUND—B. O. M. Bonebrake d. Morris Moore, 6/4,6/1; H. Van Brunt d. A. B. Carder, 8/6,3,6,7/5; Harry Bennett d. Cecil Soldanels, 6/0,6/3; J. G. Uhrlaub d. Wallace Combs, 6/0,6/2; Clarence Peterson d. J. H. Felt, 6/4,6/4; H. W. Durall d. S. J. Callahan, 6/4,6/2; George Paulette d. Ludlow Shonnard, 6/3,7/5; Carter Wilder d. T. B. Magill, 6/0,6/2; Hubert Allen d. John Foules, 2/6,6/3,6/0; Frank Howard d. Frank Motz, 6/0,6/2; Kenneth B. Uhls d. Arthur Sternberg, 6/1,6/1; Charles T. Speice d. H. J. Ebert, 6/0,6/2; R. A. Connett d. John Cunningham, 3/6,6/3,6/2; W. J. Krebs d. J. Ryan, 6/0,6/3; D. K. Campbell d. R. P. Porter, 6/2,4/6,6/4; Phil Bagby d.



(1) Mrs. J. A. Rameson (Mrs. Adelaide Yager), Great Plains Champion and Runner-up in United States Clay Court Championship. (2) Mrs. Malcolm McNeill, Chicago; Illinois State and Chicago City Champion. (3) Miss Evelyn Seavey, Runner-up Great Plains Championship.

Milton Clarke, 6/3,6/0; Walter Schmitz d. M. H. Butler, 6/3,6/3; Heath Moore d. John Fraser, 6/1,6/3. **THIRD ROUND**—Bonebrake d. Roy S. Benson, 6/3,6/2; Paul Doneghy d. H. Van Brunt by default; Bennett d. P. F. Donnelly by default; Uhrlaub d. Peterson, 6/2,6/1; Durall d. Paulette, 6/4,6/3; Allen d. Wilder, 6/4,2,6,6/4; Howard d. J. H. North, Jr., 6/3,default; Uhls d. Howard Penfold, 5/7,6,4,6/3; Speice d. H. B. Ward, 6/4,6/2; Merrill Dubach d. Connett, 6/4,6/4; Krebs d. A. E. Hawkinson, 6/2,2,6,6/3; Ernest Primm d. Campbell, 6/1,6/4; Bagby d. Arthur D. Marty, 6/1,6/0; A. H. Dickenson d. H. M. Shelden by default; Schmitz d. H. A. Mitchell by default; Moore d. William Spicer, 6/0,6/3. **FOURTH ROUND**—Bonebrake d. Doneghy, 6/4,6/2; Uhrlaub d. Bennett, 6/3, 6/2; Durall d. Allen, 6/4,6/2; Howard d. Uhls, 6/4,6/4; Speice d. Dubach, 5/7,6,2,6,6/2; Bagby d. Dickenson, 6/0,6/1; Moore d. Schmitz, 6/1,6/1. **FIFTH ROUND**—Uhrlaub d. Bonebrake, 6/2,7/5; Howard d. Durall, 6/3,10/8; Speice d. Primm, 6/1, 6/4; Moore d. Bagby, 7/5,6/3. **SEMI-FINAL ROUND**—Howard d. Uhrlaub by default; Moore d. Speice, 6/3,7/5,6/4. **FINAL ROUND**—Heath Moore d. Frank C. Howard, 6/1,6/3,6/4.

#### MEN'S DOUBLES.

**FIRST ROUND**—Bonebrake and Moore d. Peterson and Browne, 6/0,6/1; Butler and Motz d. Paulette and Schmitz, 6/2,6/4; Penfold and Dickenson d. Bennett and Callahan, 6/4,6/1; Speice and Steele d. Durall and Hawkinson, 6/2,6/4; Uhrlaub and Spicer d. Shonard and Marty, 6/2,6/2; Howard and Krebs d. Allen and Campbell, 6/2,6/4; Uhls and Bagby d. Mitchell and Bradshaw, 6/1,3/6,6/2. **SECOND ROUND**—Bonebrake and Moore d. Primm and Dubach, 6/4,10/8; Penfold and Dickenson d. Butler and Motz, 6/1,6/2; Speice and Steele d. Uhrlaub and Spicer, 6/3,9/7; Uhls and Bagby d. Howard and Krebs, 6/4, 3/6,8/6. **SEMI-FINAL ROUND**—Bonebrake and Moore d. Penfold and Dickenson, 2/6,6/4, 6/8,7/5,7/5; Uhls and Bagby d. Speice and Steele, 6/2,6/4,6/4. **FINAL ROUND**—Kenneth B. Uhls and Phil H. Bagby d. B. O. M. Bonebrake and Heath Moore, 6/2,6/3,6/3.

**CONSOLATION SINGLES**: Final Round—Howard Penfold d. B. J. Callahan, 6/3,5/7,6/1. **CONSOLATION DOUBLES**: Final Round—Callahan and Bennett d. Primm and Dubach, 6/2,6/2.

Mrs. Adelaide Yager defeated Miss Evelyn Seavey in the final of the Great Plains tourney for women, on the Rockhill courts. Mrs. R. S. Peer and Miss Marguerite Chesney won the doubles in the final match against Mrs. Yager and Miss Lyle Hayes, 1/6,6/3,6/4.

#### WOMEN'S SINGLES.

**FIRST ROUND**—Miss Katherine Cannon d. Miss Georgia Berkshire, 6/1,6/0; Miss Ruth Hager d. Miss Bess Helwig, 6/2,3/6,6/4. **SECOND ROUND**—Mrs. R. S. Peer d. Miss Catherine Dickey, 6/2,6/2; Mrs. A. J. O'Keefe d. Miss Norma Miller, 8/6,7/5; Miss Hortense Miller d. Miss Charlotte Byram, 6/4,6/0; Miss Louise Hammann d. Miss Elizabeth Forrester, 6/3,6/2; Miss Dorothy Briggs d. Mrs. A. T. B. Dunn, 6/0,6/0; Mrs. Adelaide Yager d. Miss Anabelle Meagan, 6/1,6/1; Miss Genevieve Pierce d. Miss Anne Hurd, 6/0,6/3; Miss Jane Harwood d. Miss Jane Swafford, 7/5,6/2; Miss Cannon d. Miss Harriet Smith, 6/0,3/6,6/0; Miss Marjorie Hires d. Miss Laura Small, 6/2,6/1; Miss Lyle Hayes d. Miss Catherine Myers, 6/1,6/1; Miss Evelyn Seavey d. Miss Martha McLendon, 6/2,6/0; Miss Marie Cahill d. Miss Marie Erhardt, 6/2,6/3; Miss Marion Casper d. Miss Gladys Blair, 6/4,2,6,6/3; Miss Mary Morley d. Miss Gladys Cole, 6/1,6/1. **THIRD ROUND**—Miss Marguerite Chesney d. Miss Dorothy Kancy, 6/2,6/0; Miss Hager d. Miss Virginia Rudolph by default; Miss Hayes d. Mrs. R. S. Beard, 6/2,6/0; Miss Seavey d. Miss Nellie Higgins, 6/1,6/2; Miss Cahill d. Miss Margaret Foules, 6/4,6/3; Miss Edwina Higgins d. Miss Margaret Kenney, 6/0,6/0; Miss Casper d. Miss Dorothy Fort by default; Miss Morley d. Miss Aileen Richards, 6/0,6/0; Mrs. R. S. Peer d. Miss Catherine Yeoman by default; Mrs. O'Keefe d. Miss Janet McCrumb, 6/1,6/2; Miss Hammann d. Miss Hortense Miller, 6/0,6/4; Miss Briggs d. Miss Bess Challinor, 6/0,6/0; Mrs. Yager d. Miss Pierce, 6/2,6/1; Miss Hall d. Miss Margaret Donovan by default; Miss Harwood d. Miss Grace Fahnstock, 6/1,6/0; Miss Hires d. Miss Cannon, 6/0,6/0. **FOURTH ROUND**—Mrs. Peer d. Mrs. O'Keefe, 6/2,6/3; Miss Hammann d. Miss Briggs, 6/2,6/1; Mrs. Yager d. Miss Hall by default; Miss Hires d. Miss Harwood, 6/1,6/3; Miss Chesney d. Miss Hager, 6/1,9/7; Miss Seavey d. Miss Hayes, 6/2,6/3; Miss Higgins d. Miss Cahill, 6/1,6/0; Miss Morley d. Miss Casper, 6/1,6/0. **FIFTH ROUND**—Mrs. Peer d. Miss Hammann, 3/6,6/3,8/6; Mrs. Yager d. Miss Hires, 4/6,6/3,7/5; Miss Seavey d. Miss Chesney, 6/3,6/2; Miss Morley d. Miss Higgins, 8/6,6/3. **SEMI-FINAL ROUND**—Mrs. Yager d. Mrs. Peer, 6/3,6/2; Miss Seavey d. Miss Morley, 7/5,9/7. **FINAL ROUND**—Mrs. Adelaide Yager d. Miss Evelyn Seavey, 6/3,6/2.

#### WOMEN'S DOUBLES.

**FIRST ROUND**—Mrs. Yager and Miss Hayes d. Miss Yeoman and Miss Dickey, 6/4, 6/1; Miss Hires and Miss Seavey d. Miss Briggs and Miss Dunn, 6,2,6/0; Mrs. Peer and Miss Chesney d. Miss Morley and Miss Hammann, 4/6,6/4,6/2. **SEMI-FINAL ROUND**—Mrs. Yager and Miss Hayes d. Miss Forrester and Miss Small, 6/1,6/0; Mrs. Peer and Miss Chesney d. Miss Hires and Miss Seavey, 4/6,6/4,6/2. **FINAL ROUND**—Mrs. R. S. Peer and Miss Marguerite Chesney d. Mrs. Adelaide Yager and Miss Lyle Hayes, 1/6, 6/3,6/4.

## Missouri State Championships

Despite war conditions, a large entry list was received for the Missouri State championships, held on the courts of the Kansas City Field Club, beginning August 3, 1918. While tennis far beyond the ordinary was afforded the spectators, almost half of the contestants declined to play, owing to the torrid weather.

Theodore R. Drewes, whose play throughout was of exceptionally high class, won the singles title from Charles T. Speice in the final round after losing the first set, 4/6. The final of the doubles found Drewes and Arthur Niemoeller opposing E. C. Simmons and Harry W. Durall. It was a one-sided encounter, the former pair winning in straight sets. The summaries:

### MEN'S SINGLES.

FIRST ROUND—Phil Bagby d. Arthur Marty, 8/6,6/4; Kenneth B. Uhls d. Joe Geisel, 6/2,6/2; Proctor Wright d. Herbert Sack, 6/0,6/1; Walter Schmitz d. Webster Hallett, 6/0,6/0; Paul Proctor d. Ward Miller, 6/3,4,6,10,8; W. D. Singleton d. George M. Noble, 6/1,6/1. SECOND ROUND—E. P. Tyner d. G. V. Glaskin, 6/0,6/4; Uhls d. M. Dubach, 6/2,6/1; Schmitz d. Wright, 6/1,14/12; M. Moore d. Carter Wilder, 6/3,6/1; Proctor d. G. B. Mitchell, 6/1,6/4; Ray Trosper d. Singleton, 6/2,6/1; K. Dubach d. John Stoller, 6/4, 6/0; J. R. Manning d. J. W. Widner, 6,1,6/1; E. C. Simmons d. W. H. Ferguson, Jr., 6/0,6/0; Paul G. Enns d. Wilson Riley, 6,1,6/4; Charles T. Speice d. George Golding, 6/0,6/1; Claude Ferguson d. George Paulette, 3,6,6,4,6/4; Marion D. Waltner d. W. F. Henderson, 6/3,6/3; Harry A. Bennett d. Wallace Kunz, 6/0,6/0; Cecil Soldanel d. Fay R. Maulton, 6,1,6/2. THIRD ROUND—Tyner d. Roy Talpey by default; Arthur Niemoeller d. Morris Butler, 6/3,7/5; H. Moore d. Ernest Primm, 5,7,6,2,6/4; Uhls d. Schmitz, 6/1,6/3; M. Moore d. Owen Biggs, 6,1,6/0; John Foulcs d. Proctor, 6/2,7/5; Trosper d. K. Dubach, 6/2,6/1; Simmons d. Manning, 6/4,6,1; Enns d. H. S. Mitchell by default; Speice d. Ferguson, 6/0,6/2; B. H. Greenburg d. Waltner, 8,6,6/4; Bennett d. James Bradshaw, 2,6,6,3,6,1. FOURTH ROUND—Tyner d. Durall, 6,3,6/2; H. Moore d. Niemoeller, 6/0,3,6,6/2; Theodore R. Drewes d. Bagby, 6,0,6,2; Uhls d. M. Moore, 6/0, 6/2; Trosper d. Foulcs, 3,6,6/3,2,6; Simmons d. Enns, 6,1,7/5; Speice d. Greenburg, 6/0, 6/1; Bennett d. Soldanel, 6/1,6/2. FIFTH ROUND—H. Moore d. Tyner, 6/0,6/1; Drewes d. Uhls, 6/4,6/3; Simmons d. Trosper, 6,1,6,4; Speice d. Bennett, 6,1,6/4. SEMI-FINAL ROUND—Drewes d. H. Moore, 6,4,6,3,6,2; Speice d. Simmons, 6,3,2,6,4,6,7,5,7/5. FINAL ROUND—Theodore R. Drewes d. Charles T. Speice, 4,6,6,4,6,2,6/0.

### MEN'S DOUBLES.

FIRST ROUND—Waltner and Ferguson d. George M. Noble and Lawrence E. Zentz, 6/0,6/2; Simmons and Durall d. Bradshaw and Butler, 6/3,6/2; Uhls and Bagby d. Johnson and Paulette, 6/1,6/2; Hubert Allen and Frank Motz d. M. Moore and Wallace Kunz, 8,6,6/4. SECOND ROUND—Primm and Dubach d. Speice and Trosper, 6/3,2,6,6/1; Simmons and Durall d. Waltner and Ferguson, 6,1,6/1; Uhls and Bagby d. Allen and Motz, 6/1,6/1; Drewes and Niemoeller d. Krebs and Butler, 6,4,6,3. SEMI-FINAL ROUND—Simmons and Durall d. Primm and Dubach, 6/3,7/5,6/3; Drewes and Niemoeller d. Uhls and Bagby, 6/3,6/3,6,4. FINAL ROUND—Theodore R. Drewes and Arthur Niemoeller d. Edward C. Simmons and H. W. Durall, 6,1,6,4,6/2.

## Central West Women's Championships

The Central West women's championships, held by the Kansas City Field Club, beginning August 5, 1918, proved of considerable interest. Miss Corinne Gould played through the tournament without a hitch and in the final round defeated Miss Evelyn Seavey in straight sets. Miss Gould did not appear in the doubles, which went to Miss Marjorie Hires and Miss Evelyn Seavey. The summaries:

### WOMEN'S SINGLES.

FIRST ROUND—Miss Marjorie Hires d. Miss Edwina Higgins, 6/0,6/0; Miss Dorothy Helms d. Miss Marion DeBaun, 6/1,8,6; Miss Corinne Gould d. Miss Gene Pierce, 6/0, 6/2; Miss Martha McLendon d. Miss Virginia Rudolph, 6/2,2,6,7/5; Mrs. R. S. Peer d. Miss Ruth Hager, 10/8,6/3; Miss Louise Hammann d. Miss Katherine Beebe, 6/1,6/0; Miss Evelyn Seavey d. Miss Frances Helms, 6/0,6/0; Miss Cyra Sweet d. Miss Helen Miller, 6/4,6/4. SECOND ROUND—Miss Hires d. Miss Marguerite Chesney, 6/3,5/7,6/2; Miss

Gould d. Miss Helms, 6/0,6/0; Miss McLendon d. Miss Marion Geisel, 7,9,6/2,6/3; Mrs. Peer d. Miss Marjorie Foules, 6/2,6/2; Miss Hammann d. Mrs. Kenneth B. Uhls, 6/1,6/1; Miss Seavey d. Miss Nellie Higgins, 6/1,6/0; Miss Lyle Hayes d. Mrs. C. A. Morgan, 6/4,6/3; Miss Mary Morley d. Miss Sweet, 6/1,3,6,6/0. THIRD ROUND—Miss Gould d. Miss Hires, 6/2,7/5; Mrs. Peer d. Miss McLendon, 6/2,3,6,6/3; Miss Seavey d. Miss Hammann, 6/1,6/2; Miss Morley d. Miss Hayes, 6/1,6/2. SEMI-FINAL ROUND—Miss Gould d. Mrs. Peer, 6/0,6/3; Miss Seavey d. Miss Morley, 3,6,7,5,6/4. FINAL ROUND—Miss Corinne Gould d. Miss Evelyn Seavey, 6/3,6/1.

#### WOMEN'S DOUBLES.

FIRST ROUND—Miss Hires and Miss Seavey d. Miss Helms and Miss Miller, 6/1,6/1; Miss Morley and Miss Hammann d. Miss Helms and Miss Marion Geisel, 6/1,6/4. SEMI-FINAL ROUND—Miss Hires and Miss Seavey d. Miss Chesney and Mrs. Peer, 6/3,6/1; Miss Morley and Miss Hammann d. Miss Gould and Miss Hayes, 6/3,6/0. FINAL ROUND—Miss Marjorie Hires and Miss Evelyn Seavey d. Miss Mary Morely and Miss Louise Hammann, 6/4,6/3.

## Kansas State Championships

The third annual tournament for the championships of Kansas was held on the six new courts of the Independence Lawn Tennis Association from July 8 to 12, 1918. Although handicapped by the absence of the younger element of players who were in the service, the association was fortunate in securing a good out-of-town and State entry, and as a result there were many closely contested matches. Kenneth B. Uhls of Kansas City won the final round of singles after a hard contest with Phil Bagby, a fellow-townsmen, and these two took the doubles. Cleo Sneed won the consolation singles and O'Brien and Featherngill the consolation doubles. The summaries:

#### MEN'S SINGLES.

FIRST ROUND—P. Bagby d. C. Sneed, 7/5,6/4; B. B. Gosch d. W. G. Clute, 6/2,3/6, 6/3; E. Titsworth d. W. Hossack, 6/4,6/2. SECOND ROUND—W. L. McVey d. C. E. Osborne, 6/1,6/2; G. H. Kreinhagen d. L. Hackmaster, 6/0,6/0; John Gilmore d. J. Brown, 7/5,6/4; P. Bagby d. Gosch, 6/0,6/2; F. W. Allred d. E. Titsworth, 6/3,6/4; C. E. Stewart d. C. R. Greer, 6/1,6/1; L. B. Hammond d. Roy Mathews, 6/0,6/1; E. Sewell d. L. Root, 6/0,6/2; Kenneth B. Uhls d. C. Robinson, 6/1,6/0. THIRD ROUND—McVey d. Kreinhagen, 6/1,6/4; George Fox d. J. B. Hookett, 2,6,6/0,6/3; Bagby d. G. S. Baker, 6/0,6/0; Allred d. S. Coffman, 6/0,6/1; Hammond d. E. Stewart, 6,1,6/2; L. Dewitt d. J. K. Shinn, 6/0,8/6; Uhls d. Sewell, 6/1,6/3. FOURTH ROUND—McVey d. Fox, 6/2,6/0; Bagby d. Gilmore, 6/0,6/2; Hammond d. Allred, 9/7,9/7; Uhls d. Dewitt, 6/1,6/3. SEMI-FINAL ROUND—Bagby d. McVey, 6/4,5/7,9/7,6/4; Uhls d. Hammond, 6/2,6/1,6/1. FINAL ROUND—Kenneth B. Uhls d. Phil Bagby, 7/5,2,6,6/2,5,7,10/8.

#### MEN'S DOUBLES.

FIRST ROUND—Stewart and Baker d. Osborne and G. Smith, 8/6,6/2; Uhls and Bagby d. Meinhardt and Fox, 6/0,6/1; Sneed and Titsworth d. Hookett and Brown, 6/1,6/4. SECOND ROUND—Gosch and Dewitt d. Stewart and Baker, 6,0,7/5; Uhls and Bagby d. O'Brien and Featherngill, 6/0,6/0; McVey and Allred d. Clute and Sewell, 6/3,6/1. SEMI-FINAL ROUND—Uhls and Bagby d. Gosch and Dewitt by default; McVey and Allred d. Sneed and Titsworth, 10/8,6/1,6/4. FINAL ROUND—Kenneth B. Uhls and Phil Bagby d. W. L. McVey and F. W. Allred, 6/1,6/2,6/2.

Western Intercollegiate Championships.—Only four universities of the "Big Ten" were represented in the 1918 tournament for the Western intercollegiate championships, held on the University of Chicago courts, May 23-25. They were Chicago, Michigan, Minnesota and Wisconsin. Two Chicago players, Ruthren Pike and Nash, fought it out for the singles honors, the former winning, 5/7,6/3,6/3,6/4. In the doubles, Adams and Weden of Minnesota proved to be the best pair by trimming Hammen and Nielsen of Wisconsin in the final round, 6/4,6/1,8/10,8/6.

Interstate Championships.—In one of the best matches ever played in Sioux City, Iowa, Harold H. Penfold won the 1918 Interstate championship, held by the Interstate Tennis Club, beginning August 7, defeating William U. Knight after five well played sets in the final, 6/4,2,6/6,0,5/7,6/3. The battle for the doubles honors was hard fought, the decision going to John Barton and Kenneth Rerick, who disposed of Clark A. Stone and C. S. Carey in the final round, 6/8,6/4,7/5,6/2.

Des Moines City (Iowa) Women's Championship.—The 1918 city championship for women was held at the Des Moines Golf and Tennis Club in June, and resulted in a victory for Miss Frances Ammons after a hard three-set match with Mrs. F. W. Ebers in the final round, 9/7,1,6,6/1.

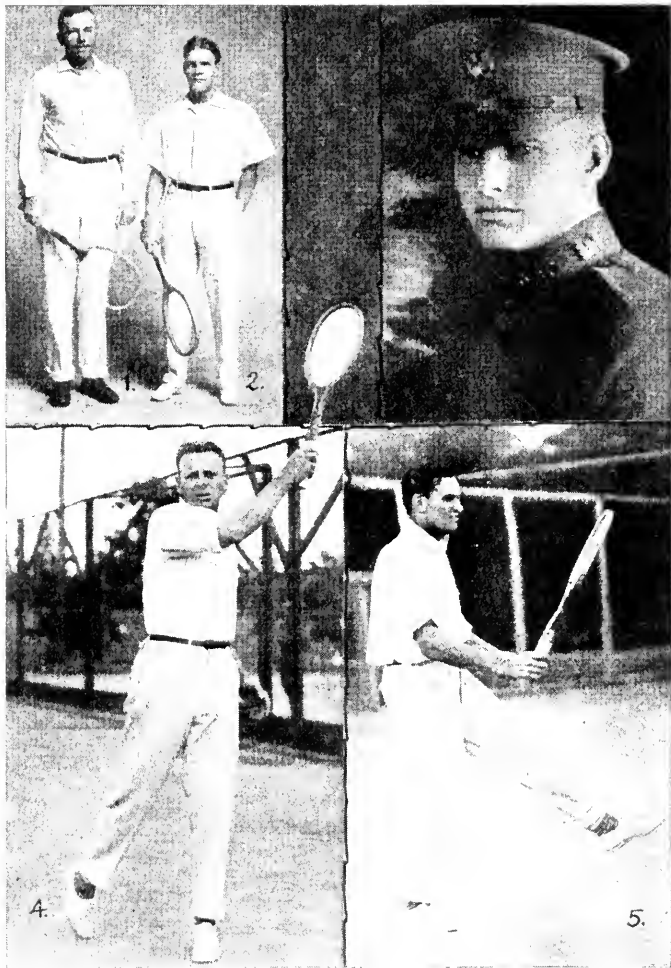

1 and 2. B. M. Grant and Nat Thornton, Southern Doubles Champions. 3. Douglas Watters, New Orleans. 4. Carleton Y. Smith, Southern Champion. 5. J. B. Adoue, Jr., Texas State and Border States Champion in singles and doubles.



## Southern Tournaments

### Southern Championships

While the class and number of entries were affected by the war, the tournament for the Southern championships, held on the courts of the Atlanta Athletic Association, Atlanta, Ga., during the first week in July, 1918, was successful and full of interest. Carleton Y. Smith defeated E. V. Carter, Jr., in the deciding round of the singles, Carter making his best stand in the first set, which he carried to 9/7. B. M. Grant and Nat Thornton defeated E. V. Carter, Jr., and J. K. Orr, Jr., in the final round of doubles after a four-set match.

Miss Irving Murphy of New Orleans won the cup in the singles for the third time and it became her permanent property. The consolation singles went to Ed Czintz, who defeated his brother, C. I. Czintz, Southern junior champion, 5/7,6/2,6/4. An exhibition doubles match was won by Carleton Y. Smith and E. V. Carter, Jr., who defeated Conrad B. Doyle and Nat Thornton, 6/3,13/11. The summaries:

#### MEN'S SINGLES.

FIRST ROUND—E. V. Carter, Jr., d. J. K. Orr, Jr., 6/3,6/2; B. I. Rhett d. E. I. Czintz, 12/10,6/4; W. W. Quillian d. N. H. Giles, 6/2,6/2; C. Y. Smith d. R. D. Berrien, 5/3,6/1. SECOND ROUND—E. S. Mansfield d. Ernest Ramspeck, 6/4,6/4; Carter d. Rhett, 5/6,7/5; Smith d. Quillian, 6/1,6/1; Ralph Ragan d. Garrett Porter, 3/6,7/5,6/3; Percy Cox d. T. M. Wilson, 6/1,6/1. THIRD ROUND—Mansfield d. Ed Czintz, 1/6,6/4,7/5; Carter d. Henri Sabron, 6/1,6/4; Smith d. Simmons, 6/1,6/3; Cox d. Ragan, 6/1,9/7. SEMI-FINAL ROUND—Carter d. Mansfield, 6/1,6/3; Smith d. Cox, 6/2,6/4. FINAL ROUND—C. Y. Smith d. E. V. Carter, Jr., 9/7,6/3,6/1.

#### MEN'S DOUBLES.

FIRST ROUND—Giles and Williamson d. Sabron and Didot, 6/4,6/0,6/2; Grant and Thornton d. Quillian and E. I. Czintz, 6/1,6/3; Cox and Ed Czintz d. Simmons and Porter, 6/3,6/2. SECOND ROUND—Carter and Orr d. Ramspeck and Ragsdale, 11/9,6/0; Giles and Williamson d. Rhett and Ragan by default; Grant and Thornton d. Cox and Ed Czintz, 6/3,8/6; Smith and Mansfield d. Cooper and Berrien, 6/1,6/2. THIRD ROUND—Carter and Orr d. Giles and Williamson, 6/1,6/0; Grant and Thornton d. Smith and Mansfield, 2/6,6/4,8/6,6/4. FINAL ROUND—B. M. Grant and Nat Thornton d. E. V. Carter, Jr., and J. K. Orr, Jr., 6/4,4/6,6/3,6/1.

#### WOMEN'S SINGLES.

FIRST ROUND—Miss Frances Kern d. Miss Katherine Crandall, 6/1,8/6. SEMI-FINAL ROUND—Miss Willis Drummond d. Miss Kern, 6/4,6/3; Miss Irving Murphy d. Miss Mabels, 6/2,6/3. FINAL ROUND—Miss Irving Murphy d. Miss Willis Drummond, 6/0,6/3.

## North Carolina State Championships

Players from Atlanta dominated the tournament for the North Carolina championships, held at the Asheville Country Club, beginning August 26, 1918. Carleton Y. Smith won the singles by defeating E. V. Carter in the final round, and also the mixed doubles with Mrs. R. B. Randolph as a partner. The pair won from Miss Therese Chapman and E. S. Mansfield in the finals, 7/5,7/5. J. K. Orr, Jr., and E. V. Carter took the men's doubles. Mrs. Robert Johnston won the women's singles, and with Miss Therese Chapman the doubles. Eugene Jones won the consolation singles. The summaries:

#### MEN'S SINGLES.

FIRST ROUND—E. S. Mansfield d. Eugene Jones, 7/5,7/5; C. Y. Smith d. Charles Dau, 5/0,6/1; Robert Johnston d. W. Bartlett, Jr., 7/5,9/7. SECOND ROUND—J. K. Orr, Jr., d. Henry Sabron, 6/4,6/1; E. V. Carter d. Mansfield, 6/3,6/1; Smith d. Johnston by

default; E. V. Stringfield d. Bretney Smith, 6/1,6/2. SEMI-FINAL ROUND—Carter Orr, 6/0,6/3; Smith d. Stringfield, 6/0,9/7. FINAL ROUND—Carleton Y. Smith d. E. Carter, 6/3,6/3,3/6,6/4.

#### MEN'S DOUBLES.

FIRST ROUND—C. Y. Smith and E. S. Mansfield d. E. V. Stringfield and Bretney Smith, 6/2,6/4. SEMI-FINAL ROUND—Smith and Mansfield d. Henry Sabron and F. V. Thomas, 6/4,6/3; J. K. Orr, Jr., and E. V. Carter d. Robert Johnston and Eugene Jon by default. FINAL ROUND—J. K. Orr, Jr., and E. V. Carter d. C. Y. Smith and S. Mansfield, 10/8,10/8,6/3.

#### WOMEN'S SINGLES.

FIRST ROUND—Miss Helen Brigham d. Mrs. D. C. Waddell, 6/3,6/3; Mrs. Robert Johnston d. Miss Therese Chapman, 6/1,6/4. SEMI-FINAL ROUND—Mrs. Johnston Miss Brigham, 6/3,4/6,6/0; Mrs. R. B. Randolph d. Mrs. R. T. Garrison, 7/5,4/6,7/5. FINAL ROUND—Mrs. Robert Johnston d. Mrs. R. B. Randolph, 5/7,7/5,6/1.

#### WOMEN'S DOUBLES.

FIRST ROUND—Mrs. Clarence Hobart and Mrs. T. C. Coxe d. Mrs. D. C. Waddell and Mrs. R. T. Garrison, 6/2,6/1; Miss Therese Chapman and Mrs. Robert Johnston d. Mrs. R. B. Randolph and Mrs. Alan McDonald, 6/4,6/2. FINAL ROUND—Miss Therese Chapman and Mrs. Robert Johnston d. Mrs. C. Hobart and Mrs. T. C. Coxe, 6/3,8/6.

MIXED DOUBLES: Final Round—Mrs. R. B. Randolph and C. Y. Smith d. Miss Therese Chapman and E. S. Mansfield, 7/5,7/5.

## Florida State Championships, 1919

Fred H. Harris of Brattleboro, Vt., signalized his first appearance at Palm Beach by winning the Florida State championship of 1919, held on the Palm Beach Tennis Club courts, beginning March 1. He had Craig Biddle of Philadelphia, the 1916 winner, as his opponent in the final round, and while Biddle played his usual careful, steady game, Harris worked the harder, had more weight behind the ball, and won in four sets. In the doubles, with Goldman as a partner, Harris was put out in the semi-final round.

The playing of Miss Bjurstedt was the outstanding feature among the women contestants. She annexed the singles and doubles titles without losing a set but before victory perched on her banner in the mixed doubles, Miss Bjurstedt and Fred Harris lost the first set to Miss Eleonora Sears and Craig Biddle, 4/6. The summaries:

#### MEN'S SINGLES.

FIRST ROUND—A. H. Chapin d. F. T. Frelinghuysen, 6/2,6/2,6/2; Artemas Holmes d. B. H. Kuechen, 6/1,6/4; Fred H. Harris d. E. F. Torrey, 6/0,6/0; Q. A. S. McKean d. Ogden Phipps, 6/1,6/0. SECOND ROUND—Manfred Goldman d. S. G. Mortimer, 4/6,6/3,6/6; Craig Biddle d. C. C. Warren, 6/1,6/2; G. C. Shafer d. J. S. Phipps, 6/4,6/3; A. H. Chapin d. G. L. Kingsland, 6/1,6/3; Harris d. Holmes, 6/0,6/2; McKean d. Frederick Lewisohn, 6/1,8/6; G. S. Bryan d. Neal Chapin, 6/1,6/1; F. C. Inman d. B. Symonds, Jr., 6/1,6/1. THIRD ROUND—Biddle d. Goldman, 6/1,6/4; Shafer d. A. H. Chapin, 6/3,6/0; Harris d. McKean, 6/2,6/2; Inman d. Bryan, 6/2,6/3. SEMI-FINAL ROUND—Biddle d. Shafer, 6/11/9; Harris d. Inman, 4/6,6/1,6/4. FINAL ROUND—Fred H. Harris d. Craig Biddle, 6/3,4/6,6/1,6/1.

#### MEN'S DOUBLES.

FIRST ROUND—Inman and Holmes d. Bryan and A. H. Chapin, 6/1,6/1; Shafer and Frelinghuysen d. McKean and Kingsland, 7/5,6/0; Harris and Goldman d. Warren and Morris, 6/1,6/4; Biddle and Mortimer d. Torrey and J. S. Phipps, 6/2,6/3. SEMI-FINAL ROUND—Inman and Holmes d. Shafer and Frelinghuysen, 7/5,6/3; Biddle and Mortimer d. Harris and Goldman, 1/6,6/1,6/0. FINAL ROUND—Craig Biddle and Stanley G. Mortimer d. Fred C. Inman and Artemas Holmes, 6/0,4/6,6/1,6/2.

#### WOMEN'S SINGLES.

FIRST ROUND—Mrs. F. Lewisohn d. Mrs. I. Hawkes, 6/4,4/6,6/1; Miss Eleonora Sears d. Mrs. F. Richardson, 6/0,6/0; Mrs. J. L. Bremer d. Miss A. Tilford, 6/3,6/3; Mrs. F. L. Wood d. Miss M. Toulman, 3/6,6/1,6/1. SECOND ROUND—Miss Molla Bjurstedt d. Mrs. A. H. Chapin, 6/1,7/5; Miss Sears d. Mrs. Lewisohn, 6/0,6/2; Mrs. Wood d. Mrs. Bremer, 6/4,7/5. SEMI-FINAL ROUND—Miss Bjurstedt d. Miss Sears, 6/4,6/4; Mrs. Wood d. Miss Robbins by default. FINAL ROUND—Miss Molla Bjurstedt d. Mrs. Rawson L. Wood, 6/1,6/2.

## WOMEN'S DOUBLES.

FIRST ROUND—Mrs. Shaw and Mrs. Bremer d. Mrs. Chapin and Miss Toulman, 6/1, 6/6/3; Mrs. Lewisohn and Miss Lewisohn d. Miss Tifford and Miss Mc'Cook, 6/4,7/5; ss Sears and Mrs. Wood d. Miss Moore and Miss Hine, 6,1,6 2. SEMI-FINAL ROUND Miss Bjurstedt and Mrs. Whitman d. Mrs. Shaw and Mrs. Bremer, 6 2,6 2; Miss Sears d. Mrs. Wood d. Mrs. Lewisohn and Miss Lewisohn, 6 2,6 1. FINAL ROUND—Miss Ella Bjurstedt and Mrs. H. H. Whitman d. Miss Eleonora Sears and Mrs. Rawson L. pod, 6/3,6/4.

FIXED DOUBLES: Final Round—Miss Molla Bjurstedt and Fred H. Harris d. Miss Eleonora Sears and Craig Biddle, 4 6,6,1,7/5. MEN'S CONSOLATION SINGLES: Final und—Stanley G. Mortimer d. Fred T. Frelinghuysen, 13/11,6 3.

## Championships of Cuba

The 1917 champions of Cuba met with quite a setback in the championships 1918, held at the Vedado Tennis Club, Havana, beginning March 31. In the men's singles, G. de Zaldo suffered defeat in the semi-final round at the hands of A. Macia, who showed himself to be a good and fast player. Macia continued his success in the final round, defeating A. Casuso in straight sets. In the doubles, the old champions, de Zaldo and F. Martinez, were put out in the first round by Zayas and Casuso, who finally won the event.

Senorita M. Cabarga, who was on the winning end of all the women's events, played a brilliant game. She had an easy time in winning the singles, and with Senorita M. Ramirez annexed the doubles final in straight sets, and with O. Ramirez as her partner placed the mixed doubles to her credit.

**Southern Intercollegiate Championships.**—The players of Georgia Tech carried off the honors in the 1918 tournament for the Southern intercollegiate championships, held on the courts of the Atlanta Athletic Club on May 13. In the final round of singles, F. C. Jones of Georgia Tech defeated G. P. Howard, 6 2,6 2,6 1. These two players in the doubles won in the final round from Lee T. Barber and Earle Sellers of Mercer University, 6 3,6 2,6 2.

**Pinehurst Mid-Winter Tournament, 1919.**—Under excellent playing conditions, the annual mid-winter tournament of the Pinehurst (N. C.) Country Club was successfully completed, January 6-11. The final round brought together C. F. Watson, Jr., of New York, and Nathan H. Bundy of Norfolk, Va. The match went the full five sets, Watson finally winning, 6 4,6 4,2 6 4 6,6 1. Bundy and R. L. James took the doubles from G. T. Aranyld and Count Otto Salm, 1/6,6 1,6 2,6 4. Miss Carrie Bogart of Elizabeth, N. J., won the women's singles, defeating Miss Marjorie Lake in the final, 6 0,6 2. Miss Lake and Count Im took the mixed doubles from Miss Bogart and N. C. Rose, 6 4,6 2.

**Border States Championships.**—The tournament for the Border States championships, which was held at the El Paso Country Club, El Paso, Tex., beginning May 30, 1918, brought a good field of competitors and resulted in a display of tennis rarely seen in El Paso. That city carried off the premier honors, as its representatives won both the singles and doubles. Norman Ferguson defeated Eddie Simmons of Los Angeles, Cal., in the final round of singles, 6 3,6 4,6 2, and in the doubles, Ferguson and Captain Land won from Christie and Bailey in the final, 6 4,6 1,6 1. Miss Chesney of Phoenix defeated Mrs. Sutton of Tularosa in the final round of the women's singles, 6 3,6 1, and Miss Orndorff and Miss Rawlings won from Mrs. Sutton and Mrs. Mather in the doubles all, 6 4,7 5. In the veterans' singles, Dr. McGee defeated Dr. Smith in the final round, 4,6 4, and Neff and Conley took the doubles from Dent and Monro, 6 2,1 6 4 6,8 5,6 3.

**Isthmian Tennis Association Championship.**—In one of the best tournaments ever held at the Isthmus of Panama, Lieutenant Commander Eugene Overton, formerly of Los Angeles, Cal., executive officer of the Coco Solo Submarine Base, won the premier honors for 1918, including the Governor's Cup, presented by Governor Harding. The tournament as held on the courts on the Pacific side of the Isthmus, beginning August 11 and continuing, owing to unfavorable weather, until August 18. Lieutenant Commander R. D. Atwood, winner of the trophy in 1917, was eliminated in the second round by Overton, and the final round brought together Overton and Robert Harding, son of the governor and a student at West Point. This match was a fine exhibition of generalship and tournament experience displayed by Overton against his more youthful and anxious opponent, who seemed inclined to be nervous and wild at times. Overton won, 6 3,7 5. L. Strauss, another California player who was defeated in the second round by Harding, improved in his playing so much that on Labor Day, in the Officers' invitation tournament at Coco Solo, he overpowered Colonel W. H. Wilson in straight sets, 6 1,6 1.

## Intermountain Tournaments

### Colorado State Championships

Don Harker, Colorado State singles champion, retained his title when he defeated W. M. Fanning in straight sets in the final round of the tourney held on the Denver Country Club courts, commencing August 25, 1918.

Harker and E. R. Bailey won the men's doubles, defeating Park McLaughlin and Neil King, two young players of much promise, in the final round. Their hardest match was the semi-final contest with Morey and Brooks, which they finally won after a hard fought five-set match. The summaries:

#### MEN'S SINGLES.

**FIRST ROUND**—McLaughlin d. Danner, 7/5,3/6,6/4; Harker d. Surfuh, 6/0,6/1; Patterson d. Berry, 6/3,6/3; Bailey d. Barnes, 6/0,6/0; Dorsey d. Campion, 6/1,6/0; G. Townsend d. Wright, 6/1,6/4; Fanning d. King, 6/2,6/2; Elliott d. Scott Townsend, 6/2,5/7,6/4; Liggett d. Admiral, 6/2,6/2; Clow d. Kennedy, 9/7,6/1; Clay d. Ballou, 6/1,6/4. **SECOND ROUND**—Fanning d. Stevens, 6/1,6/1; G. Shepard d. Powers, 6/1,6/4; Harker d. McLaughlin, 6/2,6/1; Bowes d. Dorsey, 6/1,6/1; Moore d. G. Townsend, 7/9,6/1,6/3; Elliott d. Clow, 6/3,2/6,6/3; Bailey d. Patterson, 6/1,6/1; Denton d. Clay, 3/6,6/4,6/2. **THIRD ROUND**—Harker d. Bailey, 6/2,6/3; Bowes d. Moore, 6/2,5/7,6/3; Denton d. G. Shepard, 6/2,6/4. **Fanning d. Elliott, 6/3,6/3. SEMI-FINAL ROUND**—Harker d. Bowes, 6/1,6/2,6/4; Fanning d. Denton, 6/4,6/4,6/3. **FINAL ROUND**—Don Harker d. W. M. Fanning, 6/3,6/1,6/2.

#### MEN'S DOUBLES.

**FIRST ROUND**—Morey and Brooks d. Berger and Field, 6/1,6/1; Harker and Bailey d. G. Shepard and Surfuh, 6/2,6/2; Clay and E. Shepard d. Denton and Hinman, 6/2,6/2; McLaughlin and King d. Fanning and Middlekauff, 8/6,4/6,6/2; Clow and Liggett d. Scott Townsend and Hill, 6/1,8/6. **SECOND ROUND**—Harker and Bailey d. Danner and Admiral, 6/0,6/2; Morey and Brooks d. Berry and G. Townsend, 6/1,6/1; McLaughlin and King d. Clay and E. Shepard, 6/2,7/6; Clow and Liggett d. Ballou and Powers, 6/3,6/2. **SEMI-FINAL ROUND**—Harker and Bailey d. Morey and Brooks, 2/6,6/3,6/1,4/6,6/4; King and McLaughlin d. Clow and Liggett, 6/2,6/4,5/7,8/6. **FINAL ROUND**—Harker and Bailey d. King and McLaughlin, 6/2,1/6,6/3,6/2.

### Denver City Tennis Tournament

Rainy weather interfered greatly with the Denver City tournament, which was held on the city park courts, commencing July 13, 1918. Don Harker, State champion, won the men's singles, defeating Tyson Dines, Jr., 1917 patriotic champion, in the final round, 6/4,6/3,6/1, thereby obtaining permanent possession of the Spalding trophy. Harker and Bailey, 1917 champions, retained the title, as they defeated the Dines brothers, 6/4,7/5,6/0. Miss Mae Meyer won the women's singles, defeating her sister, Annette, 6/4,6/4. The surprise of the tourney was the victory in the women's doubles of Miss Julia Loser and Mrs. Cline, who defeated the Meyer sisters, 5/7,6/3,6/4. Miss Loser and Don Harker won the mixed doubles event from Miss Mae Meyer and H. Clow, after an uphill battle, 1/6,6/1,6/3. Herman Clow, West Denver High School champion, won the boys' singles, defeating G. Denton in the final, 6/3,6/2,2/6,6/3. Miss Annette Meyer, 1917 girls' singles champion, retained her title when she defeated Miss Katherine Connell, 6/2, 6/4.

**Intermountain Patriotic Tournament.**—Two old rivals, George T. Badger and E. M. Garnett, had quite a tussle for the leading honors in the Intermountain patriotic tournament, held under the auspices of the Salt Lake Tennis Club during the week of August 26, 1918. The competition attracted an entry of thirty-five players in the singles and seventeen pairs in the doubles. Badger and Garnett first met in the singles, but after taking the first set, Garnett's play fell off and Badger won the next three sets handily. The score: 3/6,6/3,6/1,6/1. The men met again in the doubles with the same result. Badger had Samuel T. Neel as a partner and they defeated Garnett and A. M. Cheney in the final, 6/4,6/3,6/3.

# Northwestern Tournaments

## Tennis in the Northwest

BY ED WALKER.

Tennis in the Northwest, as generally predicted throughout the country, will have a banner season in 1919. Plans are under way to reorganize the Minneapolis Tennis Club, one of the pioneer organizations in this section of the country. The promoters of the new club plan to take over the grounds of the Minneapolis Tennis Club, erect a permanent clubhouse and appropriate \$5,000 for building new courts and improving the old ones. The project will be one of the biggest boosts the net game ever has had in the Northwest.

Tournament play last season was light. One of the features of the programme was the intercity Red Cross matches between Minneapolis and St. Paul, which resulted in an even break. It was announced that \$1,500 was raised, which included Duluth and Northfield in addition to the twin cities.

The Northwestern interscholastic tournament on the courts of the Minneapolis Tennis Club opened the tourney season. Leslie Johnson, captain of the Central High School team of Minneapolis, was the winner, defeating John Franham of St. Paul Academy in a gruelling five-set match, which took three hours to play.

The annual park tennis tournament was next in line with 175 players. Marjorie Curtis won the women's title, while Weston Painter won the men's singles, defeating Wilfred Widen, twice champion. In the doubles, Painter and his partner, Tom Clarke, both former Central High School players, were victorious.

Competition in the annual Northwestern Tennis Association championships, on the beautiful Burton courts at Deephaven, was featured by the closeness of the play. Ward Burton, president of the Minneapolis Tennis Club, and his partner, John Adams, Jr., won the doubles title, defeating Jayne of Minneapolis and E. Knoche of St. Paul. Jayne is one of the veteran players in this section and has won seven championships in nine starts in the Northwestern championship tourneys. The singles title was won by Philip Brain of Minneapolis, who defeated John McGee of St. Paul. Miss Alice Drake of St. Paul and Brain won the mixed doubles crown, winning from Jayne and Miss Ethel Lee of Minneapolis.

Brain and Jayne, shortly after the Northwestern tourney, played in the Western Canadian championships at Winnipeg, winning the doubles title by defeating Neil McLaughlin of Minneapolis and Paul Bennett of Canada. It is planned by Minneapolis officials to arrange an international tournament this season with Canada.

The 1918 championships were decided on the St. Paul Tennis Club courts, with John McGee of St. Paul winning the final match for the singles title from Pegs Albright, also of St. Paul and former champion. The doubles was won by Trafford Jayne and John Adams, Jr., who defeated J. H. Ehlers of Minneapolis and Myron Hutchinson of St. Paul.

The war hit Minneapolis tennis clubs hard, with the result that only two organizations stood the strain. The Minneapolis Tennis Club and the Kenilworth, a family organization, are the only ones left. More than 60 per cent of the members of the former club entered the service—a great record.

## Northwestern Championships

The 1918 tournament for the Northwestern championships, held on the Burton courts and under the auspices of the Minnetonka Yacht Club, at Lake Minnetonka, Minn., August 3 and following days, brought out a big field of entries and an excellent exhibition of tennis. P. S. Brain of Minneapolis and J. McGee of St. Paul fought it out for the singles honors, Brain winning after five hard sets. The doubles went to J. W. Adams, Jr., of Minneapolis and W. C. Burton of Deephaven, the pair defeating E. Knoche of St. Paul and T. N. Jayne of Minneapolis.

Miss Alice Drake went through the women's part of the tournament without the loss of a set. She met Miss Josephine Little in the final round of singles and defeated her, 6/3,6/0. Miss Drake also, in conjunction with P. S. Brain, won the mixed doubles from Miss Ethel Lee and T. N. Jayne in straight sets. The summaries:

### MEN'S SINGLES.

FIRST ROUND—S. W. Kinyon d. Hawes, 6/3,6/1; Lysle Hackney d. J. O. Ewing, 2/6, 6/2,6/3; P. S. Brain d. J. DeCoursey, 6/1,6/2. SECOND ROUND—C. G. Krause d. Sweeney, 6/2,6/2; J. McGee d. Leslie Johnson, 6/1,6/0; S. M. Kennedy d. W. S. Stone, 6/0, 6/3; F. T. Poehler d. D. R. Woodcock, 6/2,6/1; C. E. Sanders d. C. B. Pierce, 6/4,2/6, 6/4; W. S. Lafans d. Joseph White, 6/0,6/1; J. H. Ehlers d. Youngbauer, 6/0,6/1; Kinyon d. Hackney, 6/0,6/2; Brain d. Donald Moorhead, 7/5,6/4; J. W. Adams, Jr., d. Eno Knoche, 6/0,6/2; M. Lanpher d. Glenn Robertson, 6/3,6/2; A. H. Nieter d. Clark Fletcher, 2/6,6/3,9/7; W. U. Knight d. W. C. Burton, 6/3,6/4; T. N. Jayne d. F. R. Bartholomew, 6/0,6/1; George McLaughlin d. A. H. Lindley, 6/2,7/5. THIRD ROUND—McGee d. Krause, 6/3,6/4; Poehler d. Kennedy, 6/4,7/5; Sanders d. Lafans, 6/2,6/3; Ehlers d. Kinyon by default; Brain d. Adams, 1/6,6/1,6/2; Lanpher d. Nieter, 6/2,6/2; Jayne d. Knight, 7/5,6/4; M. Hutchinson d. McLaughlin, 6/2,6/0. FOURTH ROUND—McGee d. Poehler, 6/4,6/4; Sanders d. Ehlers, 6/0,6/1; Brain d. Lanpher, 3/6,6/1,6/1; Hutchinson d. Jayne, 8/6,6/4. SEMI-FINAL ROUND—McGee d. Sanders, 6/4,7/9,6/3,6/4; Brain d. Hutchinson, 5/7,6/1,6/0,6/3. FINAL ROUND—P. S. Brain d. J. McGee, 6/3,7/5,4/6,6/8,6/2.

### MEN'S DOUBLES.

FIRST ROUND—Sanders and Pierce d. McGee and Lanpher, 6/4,4/6,7/5,6/4; Brain and Hutchinson d. Kinyon and Krause, 5/7,6/2,4/6,6/2,6/4; Adams and Burton d. N. McLaughlin and Moorhead, 6/4,6/0,6/1; Knoche and Jayne d. Fletcher and Ewing, 6/1,6/2,6/3. SECOND ROUND—Sanders and Pierce d. DeCoursey and Weinlagen by default; Adams and Burton d. Brain and Hutchinson, 16/14,6/4,4/6,3/6,6/2; Knoche and Jayne d. Nieter and Crosby, 6/2,6/2,6/0; Knight and Ehlers d. G. McLaughlin and White, 6/1,6/2,6/0. SEMI-FINAL ROUND—Adams and Burton d. Sanders and Pierce, 5/7,7/5,6/1,6/2; Knoche and Jayne d. Knight and Ehlers, 4/6,7/5,6/4,6/3. FINAL ROUND—J. W. Adams, Jr., and W. C. Burton d. E. Knoche and T. N. Jayne, 6/3,6/3,6/1.

### WOMEN'S SINGLES.

FIRST ROUND—Miss Margaret Crosby d. Miss Betty Waite, 7/5,6/1; Miss Beatrix Thorne d. Miss Josephine Lord, 6/0,6/0; Miss Beatrice Weidenborner d. Miss Deborah Douglas, 6/2,6/2; Mrs. Donald Moorhead d. Miss Gladys Van Fossen, 6/0,6/1. SECOND ROUND—Miss Alice Drake d. Miss Margaret Dean, 6/2,6/1; Miss Clara Cross d. Miss Katherine Staunton, 5/7,6/3,6/1; Miss Ethel Lee d. Miss Crosby, 6/2,6/0; Miss Thorne d. Miss Mary Jo Moorhead, 6/1,6/2; Mrs. Moorhead d. Miss Weidenborner, 6/2,6/3; Miss Helen Cummings d. Miss Charlotte Lindley, 6/4,1/6,9/7; Miss Josephine Little d. Miss Marion Couper, 6/0,6/0; Miss Margaret Krueger d. Miss Rosamond Hagen, 1/6,6/4,6/2. THIRD ROUND—Miss Drake d. Miss Cross, 6/1,6/3; Miss Lee d. Miss Thorne, 6/1,6/1; Mrs. Moorhead d. Miss Cummings by default; Miss Little d. Miss Krueger, 7/5,6/4. SEMI-FINAL ROUND—Miss Drake d. Miss Lee, 6/3,6/0; Miss Little d. Mrs. Moorhead, 6/1,2/6,6/4. FINAL ROUND—Miss Alice Drake d. Miss Josephine Little, 6/3,6/0.

MIXED DOUBLES: Final Round—Miss Drake and P. S. Brain d. Miss Ethel Lee and T. N. Jayne, 6/1,7/5.

## Head of the Lakes Championships

A five-set match in which the contestants fought from start to finish was the special feature of the Head of the Lakes open championship tournament, held on the Duluth Boat Club's courts, Duluth, Minn., during the week of July 27,

1918. The contestants in the severe struggle were William U. Knight of Minneapolis and J. H. Ehlers, a newcomer to Minnesota, in the final round of singles. Ehlers was within two points of the match at one time, but Knight finally pulled out ahead. Knight and Bissonette paired in the doubles and won that event rather handily, and Miss Katherine Coombs took the women's singles. The summaries:

#### MEN'S SINGLES.

FIRST ROUND—T. F. Counsilman d. Ned Buxton, 6/2,6/3; Niemeyer d. T. Akiyama, 6/3,10/8; Chadwick d. D. Deighton, 6/3,4,6,7/5; L. Kennedy d. Powell, 6/4,6/2; McCune d. Rice, 6/1,6/1; Bissonette d. Grady, 6,4,6,4; Ehlers d. H. Lamb, 6/2,6,9; C. K. Dickerman d. Miller, 6/2,6/1; J. Horak d. T. Telford, 6/3,6,4; Johnson d. Dick, 6/4,6/3. SECOND ROUND—Knight d. Counsilman, 6/2,6/1; Chadwick d. Johnson, 6/3,6/4; Kennedy d. McCune, 6/1,6,2; Ehlers d. Bissonette, 6/3,7,5; Dickerman d. Wilbur, 6,2,6/3; Horak d. H. C. Matzke, 6,4,7,5; Gillespie d. Yeo, 7,5,3,6,6,3; Niemeyer d. Dr. Spicer, 6,4,6,3. THIRD ROUND—Knight d. Niemeyer, 6/2,6/1; Kennedy d. Chadwick, 6,3,6/2; Ehlers d. Dickerman, 6/2,6/3; Horak d. Gillespie, 6/4,6/3. SEMI-FINAL ROUND—Knight d. Kennedy, 10/8,7/5,6/3; Ehlers d. Horak, 6/2,6,1,6,2. FINAL ROUND—William U. Knight d. J. H. Ehlers, 6/3,4,6,7,5,3,6,8,6.

#### MEN'S DOUBLES.

FIRST ROUND—Sam Miller and F. Wilbur d. Goldberg and Cook, 6,1,6,1; Deighton and Lamb d. Dickerman and Kennedy, 6,4,2,6,7,5; Knight and Bissonette d. Counsilman and Grady, 6,1,15,13; Chadwick and Powell d. Yeo and Colton, 6,2,2,6,9,7. SEMI-FINAL ROUND—Deighton and Lamb d. Miller and Wilbur, 6,1,6,1; Knight and Bissonette d. Chadwick and Powell, 6,2,6,1,6,2. FINAL ROUND—Knight and Bissonette d. Deighton and Lamb, 6,2,6,3,6/2.

#### WOMEN'S SINGLES.

FIRST ROUND—Miss Mary Towne d. Miss Dorothy Kusick, 6,1,6/0; Miss Barbara Buxton d. Miss Katherine Matter, 6,3,6,9; Miss Louise Frick d. Miss Katherine Johnson, 6/1,6/2; Miss Josephine Cotton d. Miss Penelope Turle, 6,3,6,1. SECOND ROUND—Miss Buxton d. Miss Towne, 6,4,7,5; Miss Katherine Coombs d. Miss Frick, 6/3,6,4. SEMI-FINAL ROUND—Miss Cotton d. Miss McCarthy, 6,4,6,4; Miss Coombs d. Miss Buxton, 6/4,6/1. FINAL ROUND—Miss Katherine Coombs d. Miss Josephine Cotton, 5,7,6,4,6/4.

## Montana State Championships

Fenimore Cady of Cœur d'Alene defeated Howard Robinson of Twin Falls, Idaho, in the final round of singles for the Montana State title, on the courts of the Butte Tennis Club, and the doubles went to Simmons and Robinson.

There were two State events, one open and the other closed. Simmons had some trouble in defeating McLeod in the semi-final of the closed singles, but he won the final from Hey handily. Simmons and Cundy won the closed doubles. Miss Lindland won the women's singles after losing the first set, and Miss Roscow and Miss Meehan took the doubles. The summaries:

#### MEN'S SINGLES.

FIRST ROUND—Simmons d. E. Merritt, 6/3,6/2. SECOND ROUND—Simmons d. McLeod, 8,6,6/2; Fenimore Cady d. Dr. Alfred Karsted, 6,1,6,2. THIRD ROUND—Cady d. Haley, 6/0,6,1; Hey d. Dalziel, 6,2,6,0. SEMI-FINAL ROUND—Robinson d. Hey, 6/2,6/2,7/5; Cady d. Simmons, 6/3,6/3,6/0. FINAL ROUND—Fenimore Cady d. Robinson, 8/6,3/6,6/1,6/0.

#### MEN'S SINGLES (CLOSED).

FIRST ROUND—McCormick d. McManus, 4/6,6/4,6/2; E. Merritt d. Munsey, 6/2,4/6,6/2; Hesse d. Rosenberg, 6,4,6/3. SECOND ROUND—McLeod d. McCormick, 6,1,6/4; Karsted d. Dalziel, 6/2,3/6,6/3; Simmons d. E. Merritt, 7/5,6/2; Hey d. Bennett, 6/2,6/0. THIRD ROUND—McLeod d. Karsted by default; Simmons d. Cundy by default; Hey d. Weberm, 6/0,6/2; Haley d. Hesse by default. SEMI-FINAL ROUND—Simmons d. McLeod, 1/6,4/6,6/4,6/1,6/0; Hey d. Haley, 6/4,6/2,6/3. FINAL ROUND—Simmons d. Hey, 6/0,6/2,6/3.

#### MEN'S DOUBLES.

FIRST ROUND—McLeod and Munsey d. Weber and McCormick, 6/0,10/8. SECOND ROUND—McLeod and Munsey d. Rosenberg and McManus, 6/2,6,3,6/1; Simmons and Robinson d. Haley and Merritt, 6/0,6/0,6/3. FINAL ROUND—Simmons and Robinson d. McLeod and Munsey, 6/1,6/2,6/3.

## MEN'S DOUBLES (CLOSED).

FIRST ROUND—Simmons and Cundy d. Weber and McCormick, 6/3,6/2; Hanmer and Ebbage d. Rosenberg and McManus, 6/2,6/2. SEMI-FINAL ROUND—McLeod and Munsey d. Haley and Merritt, 4/6,6/1,6/2,3/6,4/6; Simmons and Cundy d. Hanmer and Ebbage, 6/1,6/0,6/3. FINAL ROUND—Simmons and Cundy d. McLeod and Munsey, 6/4,6/3,6/3.

## WOMEN'S SINGLES.

FIRST ROUND—Mrs. Karsted d. Miss Roscow, 6/2,6/3; Miss Luxton d. Mrs. Cundy, 6/3,6/2; Miss Fewell d. Miss Moore, 6/4,6/2; Miss Meehan d. Mrs. Weber, 6/1,6/1; Mrs. Lindland d. Miss Nichols, 6/1,6/0; Miss McGovern d. Miss Olsen, 6/2,6/3; Mrs. Duggan d. Miss Westling, 6/0,6/2. SECOND ROUND—Mrs. Karsted d. Miss Luxton, 6/3,6/3; Miss Fewell d. Miss Meehan, 6/2,6/2; Mrs. Lindland d. Miss Reichle by default; Miss McGovern d. Mrs. Duggan, 6/2,6/3. SEMI-FINAL ROUND—Miss Fewell d. Mrs. Karsted, 6/2,6/2; Mrs. Lindland d. Miss McGovern, 6/2,6/3. FINAL ROUND—Mrs. Lindland d. Miss Fewell, 3/6,6/4,6/2.

## WOMEN'S DOUBLES.

FIRST ROUND—Miss Roscow and Miss Meehan d. Miss McGovern and Miss Nichols, 6/2,6/2. FINAL ROUND—Miss Roscow and Miss Meehan d. Mrs. Weber and Mrs. Karsted, 6/4,6/3.

MIXED DOUBLES: Final Round—Mrs. Lindland and Simmons d. Miss McGovern and McLeod, 6/4,6/3.

## Idaho State Championships

From the standpoint of entries the ninth annual tournament for the championships of Idaho was a keen disappointment. In fact, the women's events were probably unique in the history of tennis tournaments, starting as they did with eight entries in singles, four teams in doubles and the same number in mixed doubles. The players, however, were unable to play at the time scheduled, with the result that each of these three events went to the winners by default, not a match being played. This gave Mrs. A. Mortimer Van Ostrand the singles title, Miss Mabel Anderson and Mrs. Forrest White the doubles title, and Mrs. Van Ostrand and Kenneth Simmons the mixed doubles honors.

The men's singles title was won by Kenneth Simmons, who defeated Fenimore Cady in the final round, and became champion by reason of the failure of Myron Hutchinson to defend his title. The doubles went to Simmons and Howard Robinson. The summaries:

## MEN'S SINGLES.

FIRST ROUND—Kenneth K. L. Simmons d. F. W. Kettenbach, 6/1,6/0; F. D. Webb d. Lee Church, 6/0,6/0; Fenimore Cady d. Wallace Brown, 6/0,6/0; A. H. Goldstone d. S. F. Atwood, 3/6,6/4,6/4. SECOND ROUND—Simmons d. J. T. Babb, 6/1,6/1; H. S. Gray d. Webb, 6/2,6/4; Cady d. Goldstone, 6/0,6/1; William White d. Robinson, 5/7,7/5,8/6. SEMI-FINAL ROUND—Simmons d. Gray, 6/0,6/0,6/1; Cady d. White, 5/7,7/5,8/6. FINAL ROUND—Kenneth K. L. Simmons d. Fenimore Cady, 6/8,6/4,5/5 (default).

## MEN'S DOUBLES.

FIRST ROUND—Simmons and Howard Robinson d. Webb and R. N. Wright, 6/1,6/0. SEMI-FINAL ROUND—Gray and W. White d. S. F. Atwood and Goldstone, 6/2,6/1,6/0; Simmons and Robinson d. Cady and Babb, 4/6,6/3,6/2,6/4. FINAL ROUND—Kenneth K. L. Simmons and Howard Robinson d. H. S. Gray and William White, 6/0,6/2,6/3.

Minneapolis Defeats St. Paul.—The third intercity contest held during the year between Minneapolis and St. Paul resulted in a victory for the former, thus winning the rubber. Of the fifteen matches played on July 27, Minneapolis won ten; but the meeting was held on the Minneapolis courts, which was conceded to be advantageous to the winners. In the singles, John Adams and John McGee, respectively Minneapolis and St. Paul city champions, played two interesting sets, which Adams won with something to spare. Phil Brain had all he could do to defeat Myron Hutchinson of St. Paul, who carried the score to 7-all in the third set. Minneapolis was also superior in the doubles, winning four out of five matches played. The teams were made up as follows: Minneapolis—Trafford Jayne, Krause, W. U. Knight, McLaughlin, Sundberg, John Adams, Philip Brain, J. H. Ehlers, F. T. Poesher, W. S. Lafans, Weston Painter, Leslie Johnson and W. R. Rolfe. St. Paul—John McGee, Myron Hutchinson, Enno Knoche, Sidney La-kester, Fred Weinhagen, Paul Baillon, John De Courcy, Clyde Norton, Albright, McGee, Lanpher and Norton.



## Pacific Coast Tournaments

### Tennis in San Francisco and District

BY R. J. GREENBERG.

With William Johnston, John Strachan, Clarence Griffin, Willis Davis and Lin Murray away in the service of their country, the 1918 tennis tournaments in the vicinity of San Francisco lacked the class of play of former years. It was left to the youngsters and vets to keep the game alive and it was chiefly due to their enthusiasm that the tournaments were carried on as usual, all the fixtures for the year being carried through on schedule.

Mervyn Griffin, youngest brother of Lieutenant Clarence J. Griffin, and Roland Roberts carried off the major portion of the honors for the year. Prior to his enlistment in the army, Roberts annexed the San Francisco city and Pacific Coast titles, while Griffin took the Bay Counties and California State and all the junior events, until his win of the State title made him ineligible for the junior championships. Roberts showed marked improvement in all departments of his game, and on his play is clearly entitled to the honor of ranking Coast player of the year. Seventeen-year-old Mervyn Griffin, the latest star developed on the public courts of San Francisco, gives promise of adding more lustre to the California name in tennis.

Miss Helen Baker of San Francisco clearly established her claim as the best of the women players in the Bay District. For several years Miss Baker and Miss Anita Myers have been dividing the local titles between them, no new player having come forward of late to dispute their supremacy. Miss Myers won the Coast title, and Miss Baker the California State, Bay Counties and San Francisco city championships.

The Golden Gate Tennis Club, the Ladies' Park Tennis Club and the Junior Tennis Club held their tournaments every month as usual. One of the features of the year's play was a handicap mixed doubles tournament on the Golden Gate Park courts, held under the auspices of the San Francisco *Bulletin*, which drew a record-breaking entry list of 102 teams. Miss Helen Baker and Howard Kinsey were the victors, defeating Miss Helen Law and Robert Kinsey in the final in a long drawn out battle that kept the spectators on edge. A few months later the San Francisco *Call* staged a handicap tournament for the benefit of the United War Work Fund at the California Lawn Tennis Club. The tournament was the most ambitious handicap affair ever undertaken in the West, three events—men's handicap singles, women's handicap singles and mixed doubles—being on the programme. The total entry was 170 and the Kinsey brothers and Miss Helen Baker again proved their adeptness at the handicap style of play, Howard Kinsey winning the men's handicap singles, Miss Baker the women's handicap singles and Miss Mary Louise Potter and Robert Kinsey the mixed doubles.

Tennis received considerable attention at the hands of the athletic directors at the Mare Island Naval Training Camp, a few miles from San Francisco. With the game sponsored and encouraged by Captain Miller, commander of the training camp, Captain Parker and Paymaster Edward Poore, Yeoman Irving Karsky was appointed tennis director and was told to "go to it." Two fine asphalt courts were constructed under Karsky's direction and each day he



1, Roland Roberts, Pacific Coast and San Francisco City Champion. 2, Mervyn Griffin, California State and Bay Counties Champion. 3, Robert Kinsey, and, 4, Howard Kinsey, winners of leading honors in the handicap tournaments conducted by the "Call" and the "Bulletin" of San Francisco.

had a squad out on the courts learning the ins-and-outs of the game. On two occasions a number of San Francisco net stars, including Maurice McLoughlin, Roland Roberts, Mervyn Griffin, Bowie Detrick, Helen Baker and Anita Myers, played in exhibition matches on the Navy Yard courts.

The annual interclub battle was held as usual, although the number of clubs participating in the race was cut in half, due to the fact that so many of the players were playing a bigger game many miles away. The league championship was won by the California Tennis Club, with the Golden Gates in second position.

## Pacific Coast Championships

Roland Roberts of San Francisco won the 1918 Pacific Coast championship title, succeeding to the crown held by William Johnston, former national champion. Miss Anita Myers of Berkeley won the women's title, defeating Mrs. Walter Ellis of Los Angeles in the final round, in a close three-set battle.

The event was held on the courts of the Berkeley Tennis Club, beginning June 15, and drew the smallest entry in years. All the stars who graced the tournament in years past were away in the service and it was left to the youngsters and veterans to carry on, which they did with a will.

Roberts defeated Victor Breeden in the final in straight sets. The feature match of the tournament occurred in the semi-final round, when Mervyn Griffin, California's latest tennis "find," all but put the new champion out of the running in a five-set encounter. The youngster, however, came through in good style in the junior singles, defeating William Parker of San Francisco in straight sets, 6 0/6/0,6/3. The summaries:

### MEN'S SINGLES.

FIRST ROUND—Roland Roberts d. J. C. Rohlf, 6/1,6/3; W. Bates d. J. D. Holmes, 3 6/7/5,6/4; Bowie Detrick d. Frank Isaacs, 6/3,6/1; Mervyn Griffin d. William Parker, 1/9,6/4; Charles Stickney d. W. Smith, 6/2,1/6,6/2; R. J. Greenberg d. E. A. Klein, 6/2, 5/7,6/2; M. Nerson d. George Quinn, 5/7,6/2,6/4; A. Ross d. W. G. Knowlton, 6/2,4/6,6/2; Victor Breeden d. Byron Batkin, 1/6,6/3,6/4. SECOND ROUND—H. Kinsey d. Holland, 2/6,9/7,6/2; R. Roberts d. E. Levy, 6/1,6/3; Detrick d. Bates, 7/5,6/2; Griffin d. Stickney, 6/3,6/4; Greenberg d. Nerson, 6/3,7/5; Breeden d. Ross, 8/6,6/0. THIRD ROUND—Roberts d. Kinsey, 6/2,6/0; Griffin d. Detrick, 6/4,2/6,6/3; Breeden d. Greenberg, 1 6/6/1,6/4; Barker d. Hanson, 9/7,5/7,6/3. SEMI-FINAL ROUND—Roberts d. Griffin, 6 3/3 6/6/4,4/6,6/4; Breeden d. Barker, 6/0,6/0,6/1. FINAL ROUND—Roland Roberts d. Victor Breeden, 6/3, 6/4,10/8.

### MEN'S DOUBLES.

FIRST ROUND—Kennedy and Baker d. Hanson and Smith, 6/0,6/0; Griffin and Parker d. Boone and Breeden, 6/4,6/2; Klein and Levy d. Smith and Bettens, 6/2,6/1. SECOND ROUND—Kennedy and Baker d. Greenberg and Isaacs, 7/5,6/8,6/4; Griffin and Parker d. Young and Downing, 6/0,6/4; Klein and Levy d. Bates and Batkin, 6/4,3/6,10/8; Holmes and Ratchliffe d. Detrick and Rohlf, 6/3,8/10,6/0. SEMI-FINAL ROUND—Griffin and Parker d. Kennedy and Baker, 6/2,6/3; Klein and Levy d. Holmes and Ratchliffe, 6/3,6/4. FINAL ROUND—Mervyn Griffin and William Parker d. E. A. Klein and Edmund Levy, 6/3,3, 6/6/3,8/6.

### WOMEN'S SINGLES.

FIRST ROUND—Miss M. Wale d. Miss F. Parker, 6/4,6/3; Miss M. Brarens d. Miss Helen Baker, 3/6,6/4,9/7; Mrs. Cushing d. Miss N. Leimert, 6/0,6/1. SECOND ROUND—Mrs. Ellis d. Miss R. Mitchell, 6/2,6/2; Miss M. Thorn d. Miss Newell, 6/0,6/2; Mrs. Clute d. Mrs. Schoonmaker, 6/2,6/0; Miss Brarens d. Mrs. Cushing, 6/4,8/6; Miss P. Wirtner d. Mrs. Wolcott, 6/1,6/2; Miss A. Myers d. Miss M. Mehl, 6/3,6/3; Miss C. Tarilton d. Miss G. Clark, 6/0,6/0. THIRD ROUND—Mrs. Ellis d. Miss M. Thorn, 3/6,8/6,6/1; Mrs. Clute d. Miss Wale, 6/4,6/4; Miss Brarens d. Miss Wirtner, 6/2,6/3; Miss Myers d. Miss Tarilton, 9/7,6/2. SEMI-FINAL ROUND—Mrs. Ellis d. Mrs. Clute, 6/4,0/6,6/1; Miss Myers d. Miss Brarens, 4/6,6/2,6/1. FINAL ROUND—Miss Anita Myers d. Mrs. Ellis, 4,6,6/4,6/2.



1, Miss Helen Baker, California State, Bay Counties and San Francisco City Champion. 2, Miss Anita Myers, Pacific Coast Champion.

## WOMEN'S DOUBLES.

FIRST ROUND—Miss Tarilton and Mrs. Cushing d. Miss Brarens and Miss Newman, 6/4,2/6,6/1; Miss Myers and Miss Baker d. Mrs. Henry and Miss Ellis, 6/1,6/3. SEMI-FINAL ROUND—Miss Tarilton and Mrs. Cushing d. Miss Eunice Hilliard and Miss Sherman by default; Miss Myers and Miss Baker d. Miss Wale and Miss Thorne by default. FINAL ROUND—Miss Carmen Tarilton and Mrs. J. C. Cushing d. Miss Anita Myers and Miss Helen Baker, 6/4,6/0.

MIXED DOUBLES: Final Round—Miss Helen Baker and Howard Kinsey d. Mrs. J. C. Cushing and Bowie Detrick, 6/2,6/1.

## Pacific Coast Doubles

After eliminating Tom Bundy and James Davies in the stiffest kind of a contest in the semi-final round, Nat B. Browne and Frank Winne followed this up by disposing of Wallace Bates and Edmund Levy in the final round and thus became Pacific Coast doubles champions. Browne played his usual steady, reliable game, while Winne's serving and smashing could not have been improved upon. The summaries:

## MEN'S DOUBLES.

FIRST ROUND—P. Jones and Rager d. T. Johnson and Rathburn, 6/2,6/1; Bowers and Variel d. Jasper and Root, 1/6,6/4,7/5; Blakeslee and Blakeslee d. Curtis and Hicks, 6/2, 6/1; Belden and Goodwin d. Edralia and Hobgood, 6/0,6/2; Adams and Barker d. Tomi-naga and Ota, 6/1,6/0. SECOND ROUND—Hart and Warren d. Reinke and Osborne, 7/5, 6/1; Bundy and Davies d. Jones and Rager, 6/2,5/7,7/5; Bowers and Variel d. Blakeslee and Blakeslee, 8/6,6/1; Adams and Barker d. Belden and Goodwin, 4/6,5/2,6/3; Bates and Levy d. Callahan and M. Brown, 4/6,6/4,6/4; W. Hawks and Snodgrass d. Hardeman and R. Johnson, 9/7,2/6,6/1; Braly and Sinsabaugh d. Thomason and Merwin, 8/6,6/3. THIRD ROUND—Browne and Winne d. Warren and Hart, 6/4,14/12; Bundy and Davies d. Bowers and Variel, 6/2,1/6,6/2; Bates and Levy d. Barker and Adams, 6/3,6/4; Hawks and Snodgrass d. Braly and Sinsabaugh, 7/5,5/7,6/3. SEMI-FINAL ROUND—Browne and Winne d. Bundy and Davies, 6/4,3/6,6/4; Bates and Levy d. Hawks and Snodgrass, 4/6, 6/1,6/3,6/2. FINAL ROUND—Nat B. Browne and Frank Winne d. Wallace Bates and Edmund Levy, 4/6,6/1,6/2,6/2.

## California State Championships

The California State championships, held on the courts of the Berkeley Tennis Club, was the premier tennis event of the 1918 season, far overshadowing in interest and competition the Coast championship, which is supposed to take precedence. Mervyn Griffin, seventeen years of age and brother of the famous "Peck," won the title, defeating Byron Batkin in five sets in the final.

The women's event furnished all the thrills, upsets and surprises. The participants included two of the nationally known Sutton sisters, Miss Florence and Mrs. B. O. Bruce; Miss Mayme McDonald, Northwest champion; Miss Anita Myers, Pacific Coast champion, and Miss Helen Baker, who has been the most consistent winner of women's events in the Bay Counties. Against this array of talent Miss Baker was not conceded a chance to win, but to the surprise of everyone, she defeated Miss McDonald, Mrs. Bruce and Miss Sutton on successive days.

The doubles title was taken by Bowie Detrick and Byron Batkin, and the women's doubles by Miss Florence Sutton and Mrs. B. O. Bruce. Miss Florence Sutton and Mervyn Griffin won the mixed doubles, and Charles Stickney of Oakland won the veterans' singles. The summaries:

## MEN'S SINGLES.

FIRST ROUND—V. Chambers d. F. L. Lloyd, 6/2,6/2; Ray Greenberg d. C. Smith, 6/2, 6/2; Bowie Detrick d. Lieut. M. Evans, 6/1,6/1; V. Henry d. R. Hornidge, 6/3,3/6,6/4; Phil Bettens d. S. G. Hanson, 6/4,6/0; E. Lev" d. I. Karsky, 6/1,6/1; Byron Batkin d. C. La Croix, 6/1,6/2. SECOND ROUND—Dr. Weiss d. C. M. Jenks, 6/0,6/1; Mervyn Griffin d. P. Lenke, 2/6,6/4,6/4; Wilton Smith d. R. Smille, 6/1,8/10,6/2; Stanley Smith d. J. Rothchild, 6/2,6/3; Vic Breeden d. Wallace Bates, 11/9,2/6,6/4; C. F. Stickney d. B.

Shrader, 7/5,6/2; Greenberg d. Chambers, 6/3,8/6; Detrick d. Henry, 6/0,6/1; Levy d. Bottens, 6/3,8/6; Batkin d. Harris, 6/1,6/2; Holmes d. A. Kline, 7/5,6/4; G. Quinn d. A. Ross, 3/6,6/3,6/4; William Parker d. A. Rosenberg, 6/4,6/2; J. H. Jordan d. M. Nerson, 6/2,6/1; R. Kinsey d. E. Weller, 6/2,6/0. **THIRD ROUND**—Griffin d. Weiss, 8/10,6/2,6/3; Wilton Smith d. Stanley Smith, 6/4,6/3; Breeden d. Stickney, 6/4,6/4; Detrick d. Greenberg, 2/6,7/5,5/0; Batkin d. Levy, 6/3,6/4; H. Kinsey d. Holmes, 6/3,6/0; Parker d. Quinn, 6/3,6/3; Jordan d. R. Kinsey by default. **FOURTH ROUND**—Griffin d. Smith, 6/2,6/0; Detrick d. Breeden, 7/5,6/4; Batkin d. H. Kinsey, 8/10,6,1,6/4; Parker d. Jordan, 6/3,6/3. **SEMI-FINAL ROUND**—Griffin d. Detrick, 6/4,6,2; Batkin d. Parker, 6/3,7/5. **FINAL ROUND**—Mervyn Griffin d. Byron Batkin, 6/2,6/3,4/6,4,6/3.

#### MEN'S DOUBLES.

**FIRST ROUND**—Hornidge and Rothchild d. Lient, M. Evans and Harris, 6/2,6/1; Parker and Griffin d. Shrader and Van Becker, 6/0,6/3; A. Rosenberg and H. Kinsey d. I. Karsky and Roland Roberts, 6/3,7/5. **SECOND ROUND**—Quinn and Bettens d. Manocceir and Jenks, 6/4,6/3; Wallace Bates and J. C. Rohlfis d. Holmes and Ratcliff, 3/6, 6/2,6/3; Hornidge and Rothchild d. LaCroix and Jordan, 6/3,6/1; Parker and Griffin d. Smith and Switzer, 6/4,6/0; Detrick and Batkin d. Rosenberg and Kinsey, 4/6,7/5,6/1; Stickney and Smith d. Smilie and E. Fottrell, 6/0,7/5; Klein and Levy d. Chambers and Bonfield, 7/5,16/14; Breeden and Henry d. Suhr and C. Smith, 6/2,6/0. **THIRD ROUND**—Bates and Rohlfis d. Quinn and Bettens, 6/4,7/5; Parker and Griffin d. Hornidge and Rothchild, 8/6,2,6,6,2; Detrick and Batkin d. Hornidge and Smith, 5/7,8,6,6,1; Klein and Levy d. Breeden and Henry, 6/2,4,6,6/3. **SEMI-FINAL ROUND**—Parker and Griffin d. Bates and Rohlfis, 7/5,4,6,7/5; Detrick and Batkin d. Klein and Levy, 6/3,8/6. **FINAL ROUND**—Bowie Detrick and Byron Batkin d. William Parker and Mervyn Griffin, 6/1, 4/6,6/4,6/2.

#### WOMEN'S SINGLES.

**FIRST ROUND**—Miss Marion Mehl d. Mrs. S. G. Allen, 6/0,6/1; Miss Genevieve Clarke d. Miss Lorraine De Zan, 3/6,6/4,6/4. **SECOND ROUND**—Miss Helen Newman d. Mrs. A. Ford, 2/6,6/2,8/6; Miss Florence Sutton d. Miss Marjorie Wale, 6/0,6/1; Mrs. Clute d. Miss Adelaide Wirtner, 6/3,6/2; Miss Laura Herron d. Miss Anita Myers, 6/2,3/6,6/3; Miss Johanna Gunzburger d. Miss Ethel Lawton, 6/2,6/3; Miss Mehl d. Mrs. Maynard by default; Miss MacDonald d. Miss Genevieve Clarke, 6/0,6/0; Miss Helen Baker d. Miss Ruth Patrick, 6/0,6/1; Miss Tarilton d. Miss Wirtner, 6/1,7/5; Mrs. Leachman d. Miss Ruth Mitchell, 6/0,6/2; Mrs. Bruce d. Miss Schreiner, 6/0,6/2; Miss Myra Brarens d. Mrs. Tusher, 6/1,7/5; Miss Heen Taylor d. Miss Ursula Dietrich, 6/2,6/2; Miss Marjorie Thorne d. Mrs. Parker, 6/2,6/1. **THIRD ROUND**—Miss Sutton d. Miss Newman, 6/0,6/1; Miss Herron d. Mrs. Clute, 6/3,6/2; Miss Gunzburger d. Mrs. Schoonmaker, 6/4,6/3; Mrs. Cushing d. Miss Mehl, 6/2,7/5; Miss Baker d. Miss MacDonald, 6/1,6/4; Miss Tarilton d. Mrs. Leachman, 8/6,6/3; Mrs. Bruce d. Miss Brarens, 6/1,6/1; Miss Thorne d. Miss Taylor, 6/2,6/0. **FOURTH ROUND**—Miss Sutton d. Miss Herron, 6/3,6/3; Mrs. Cushing d. Miss Gunzburger, 8/6,6/3; Miss Baker d. Miss Tarilton, 6/4,6/4; Mrs. Bruce d. Miss Thorne, 6/2,9/7. **SEMI-FINAL ROUND**—Miss Sutton d. Mrs. Cushing, 7/5,6/2; Miss Baker d. Mrs. Bruce, 3/6,6/3,7/5. **FINAL ROUND**—Miss Helen Baker d. Miss Florence Sutton, 6/3,6/1.

#### WOMEN'S DOUBLES.

**FIRST ROUND**—Miss Wale and Miss Thorne d. Mrs. Long and Mrs. Tusher, 6/2,6/4; Miss MacDonald and Miss Schreiner d. Miss W. Suhr and C. Hosmer, 6/4,6/2; Miss Brarens and Miss Mehl d. Miss Speakman and Miss Dietrich, 6/1,6/4; Miss Sutton and Mrs. Bruce d. Miss Herron and Miss Gunzburger, 6/2,6/0; Miss Baker and Miss Myers d. Mrs. Clute and Miss Newman, 6/2,7/9,6/4. **SECOND ROUND**—Mrs. Cushing and Miss Tarilton d. Mrs. Leachman and Mrs. Parker, 6/3,6/3; Miss MacDonald and Miss Schreiner d. Miss Wale and Miss Thorne, 6/4,2/6,6/3; Mrs. Bruce and Miss Sutton d. Miss Mehl and Miss Brarens., 6/1,6/1; Miss Baker and Miss Myers d. Miss Taylor and Miss Patrick, 6/4,6/2. **SEMI-FINAL ROUND**—Mrs. Cushing and Miss Tarilton d. Miss Schreiner and Miss MacDonald, 6/4,6/4; Miss Sutton and Mrs. Bruce d. Miss Baker and Miss Myers, 6/2,6/2. **FINAL ROUND**—Miss Florence Sutton and Mrs. Bruce d. Mrs. Cushing and Miss Tarilton, 6/1,6/3.

**MIXED DOUBLES:** Final Round—Miss Florence Sutton and Mervyn Griffin d. Mrs. E. S. Bruce and Ray Greenberg, 6/0,3/6,10/8.

**VETERANS' SINGLES:** Final Round—C. F. Stickney d. E. A. Klein, 6/1,6/1.

## San Francisco Women's City Championship

Miss Helen Baker of San Francisco started her most successful season by winning the San Francisco city title on the courts of the California Lawn Tennis Club without the loss of a set. Her opponent in the final was Miss Anita Myers, whom she defeated 6/4,7/5.

## Bay Counties Championships

The Bay Counties tennis championships were held, as usual, on the public courts of Golden Gate Park, San Francisco. Mervyn Griffin, seventeen-year-old brother of the former national doubles champion, emerged the winner in the singles, decisively defeating Robert Kinsey in the final, 6/1,6/2,6/3. The doubles event was disappointing, a number of the better teams being compelled to default because of the influenza epidemic which was raging at the time.

No one was prepared for the ultimate win of the new champions, however. Tevis Martin and Wilton Smith, two junior players, who defeated Mervyn Griffin and Wallace Bates in the final, after the latter team had led at 2 sets love and 5/2,40/15 in the third set. Miss Helen Baker won the women's event for the third time in succession, thereby securing permanent possession of the Wickham Havens trophy.

## Tennis in Southern California

BY H. F. WELLER.

The lawn tennis season of 1918 in Southern California, while perhaps a trifle below the usual standard in class and number of entries in each of the tournaments, proved a surprise to those who had expected the game to languish because of the war.

Nine important tournaments were held during the season, starting with the Coronado affair in January and ending with the Los Angeles Country Club championships in November and December. In addition to these nine there were numerous invitation and exhibition tournaments held, many of them benefit affairs for the Red Cross or some other war fund. The proceeds from these special events reached a very considerable sum and the game takes its place well up among other branches of sport as a contributor to war activities.

Following the Coronado tournament in January, the Southern California clay court championship was held in Los Angeles, February 7-16, on the courts of the Hotel Leighton in Los Angeles, and brought out a fairly large entry. Victory in the singles event went to Kenneth Hawks, formerly of Cornell, and in the doubles to Ray Greenberg of San Francisco and Ralph Sindorf of Los Angeles. Miss Jessie Grieve of Pasadena won the women's singles.

The Southern California handicap tournament, held in the latter part of May, produced many close matches. Simpson M. Sinsabaugh, minus 30, defeated William Balihis, scratch, in the final round, 6/2,2/6,10/8. Miss Hilda Blatz, plus 15, won the singles from Miss Jessie Grieve, minus 30, in two well played sets, 7/5,6/4. R. Reinke and P. Hardeman won the men's open doubles from K. Hawks and F. Winne, the final match ending, 6/4,7/5.

The Formosa Club tournament in Hollywood, Los Angeles, was played in June. The Pacific Coast doubles in July, of course, was less interesting than usual, because of the absence of San Francisco and Los Angeles stars with the army and naval forces. The Southern California open championship was held in August and the city championship in September.

The Los Angeles County Liberty Fair championship tournament, completed Saturday, December 28, at Exposition Park, brought out the largest list of entries ever assembled for a similar series, and in the men's singles alone the list ran far above any received for any tournament in recent years.

Despite the absence of many stars in either army or navy service, there was enough "class" in evidence to make the play decidedly interesting and some

hard fought matches productive of brilliant tennis were well sprinkled through the schedule.

Eugene A. Warren won his way through in the men's singles to the title after traveling a road beset with such steady stars as Walter Bowers, Simpson Sinsabaugh and Applewhite. Following are the finals winners:

Men's Singles—Eugene A. Warren d. Hal Braly, 6/2,6/1. Women's Singles—Mrs. W. M. Henry d. Mrs. J. A. Rameson, 3/6,6/3,6/3. Men's Doubles—Warren and Adams d. Braly and Sinsabaugh, 6/3,6/3. Mixed Doubles—Mrs. Henry and Sinsabaugh d. Mrs. Rameson and Ketchum, 8/6,8/6. Junior Singles—Deffebaeh d. Bullock, 2/6,6/4,8/6. Junior Doubles—Ferrandini and Hunley d. Stillwell and Berry, 5/7,6/2,6/3. Boys' Singles—Stillwell d. Bryant, 6/1,9/7. Boys' Doubles—Gardner and Stillwell d. Hookstratten and Wheaton, 6/2,7/5.

Due to the disastrous fire which visited the picturesque Ojai Valley in the latter part of 1917, it was impossible to stage this popular tourney in the Valley, and for a time it seemed as if the twenty-fourth annual interscholastic tournament would not be held; but finally the Southern California Lawn Tennis Association, with the sanction of the Ojai Valley Tennis Club and the Southern California Interscholastic Federation, determined to undertake to have the play take place in Los Angeles.

The tournament was held on the four cement courts of the Y.M.C.A. athletic field in Los Angeles, April 24-27. This was the first time since the institution of the event that it had been held elsewhere than on the Thacher School courts. The large entry list showed conclusively that the Association's effort to perpetuate this tournament was a wise move. The finalists follow:

Men's Open Singles—Frank P. Winne d. Robert Rager, 6/3,6/4. Men's Open Doubles—Kenneth Hawks and Frank Winne d. Simpson M. Sinsabaugh and James Davies, 8/6,6/3. Women's Open Singles—Miss Jessie Grieve d. Mrs. Yager, 10,8,1/6,7/5. Mixed Doubles—Miss Marion Williams and S. M. Sinsabaugh d. Mrs. Yager and George Sinclair, 6/3,10/8. Boys' Interscholastic Singles—Lyle Hackney (Pasadena H.S.) d. Charles Deffebaeh (Manual Arts H.S.), 6,3,6/3. Boys' Interscholastic Doubles—Edw. Simmons and David Brieker (Los Angeles H.S.) d. Jerome and Johnson (Santa Ana H.S.), 6/3,6/3. Girls' Interscholastic Singles—Miss Marion Williams (Bishops) d. Miss Helen Huff (Alhambra), 6/0,6/2. Girls' Interscholastic Doubles—Miss Helen Huff and Miss Dorothy Lane (Alhambra) d. Miss G. Kelley and Miss Lynn (So. Pasadena), 6/1,6/4. James Davies won the intercollegiate singles and Leon Godshall and Ralph Sindorf took the doubles.

California Lawn Tennis Club, San Francisco.—The team representing this club emerged victors in the third annual Northern California interclub event. The number of clubs entered totaled six, just one-half the entry of the previous year. California's closest competitors were the Golden Gates of the same city, who, as in a previous year, defeated the league champions, but fell before some team lower down in the percentage table because some of their men failed to put in an appearance. Al Rosenberg, Bowie Detrick, Howard Kinsey, Robert Kinsey and Lloyd Baldwin were the players on whom the California Club relied to bring home the championship and another win on the beautiful Spalding trophy. Standing of the clubs:

|                   | Won. | Lost. | P.C. |                  | Won. | Lost. | P.C. |
|-------------------|------|-------|------|------------------|------|-------|------|
| California .....  | 29   | 6     | .829 | Sacramento ..... | 17   | 18    | .486 |
| Golden Gate ..... | 24   | 11    | .686 | Berkeley .....   | 14   | 21    | .400 |
| Oakland .....     | 21   | 14    | .600 | Alameda .....    | 0    | 35    | .000 |

Los Angeles (Cal.) City Championships.—The tournament for the Los Angeles championships brought out a big field of contestants and the play throughout was sharp and interesting. In the singles Perry E. Jones defeated Fred Adams in the final round, 9/7, 3/6,6/3, while S. M. Sinsabaugh and Nat Browne disposed of Jones and Roland Reinke in the final, 6/4,6/1. Miss Gladys Widdowson defeated Mrs. J. A. Rameson in the final of the women's singles, 6/0,7/5, and Mrs. Rameson and Sinsabaugh put out Mrs. Widdowson and Jones in the final of the mixed doubles, 6/2,3/6,6/4.

Mexico's Extraordinary Singles Tournament.—This tournament, which was held under the auspices of the Junior Club of Mexico last December, attracted an entry list of ninety-six players, sixty-four of which participated in the matches. Claude Butlin, who is rated as the best player in that country, had no trouble in carrying off the honors, his principal opponent being Carlos Contrevas, whom he defeated in the final round, 6/1,6/2,7/5. Butlin is an Englishman by birth, but for many years has made Mexico his home. Some time ago Butlin participated in the Texas State championship and won the title.



# Pacific Northwest Tournaments

## Pacific Northwest Championships

War had its effect on the entries to the Pacific Northwest championships, held on the courts of the Tacoma Lawn Tennis Club, Tacoma, Wash., during the week of July 29, 1918, owing to many Western players being at the front and at training camps; but what the list lacked in numbers was offset by the quality of tennis displayed.

Lieut. H. C. Breck, who was stationed at Camp Lewis, just outside of Tacoma, won the championship and Thorne Cup in singles, defeating Lieut. Herbert Hahn, a member of the regular army, after a hard played four-set match. The doubles was taken by Hahn and Richards, who won from W. Scott and R. A. Wabraushek in one of the best matches of the tournament.

The men's sectional doubles went to Breck and Pringle, who defeated Brown and Wabraushek after five nip-and-tuck sets in the final round.

Miss Sara Livingstone and Miss Mayme McDonald fought it out as they have done for many years in the women's singles, but this time Miss McDonald secured the honors. The doubles went to Miss McDonald and Miss Schreiner. Mrs. Cushing and Brant Wickersham took the mixed doubles. The summaries:

### MEN'S SINGLES.

**FIRST ROUND**—P. Neer d. J. Kerr, 6/2,6/2; C. Pessemier d. A. Merritt, 6/0,6/1; J. Wright d. Guy Flye, 7/5,8/6. **SECOND ROUND**—A. Pessemier d. H. Phelps, 6/1,6/1; B. Vickersham d. C. Buffington, 6/3,6/1; L. Brown d. H. Stevens, 6/3,3/6,6/3; R. A. Wabraushek d. H. Hewitt, 3d, 6/0,6/3; B. Kautz d. M. Davis, 6/4,7/5; H. Hahn d. Neer, 2/6,3; C. Pessemier d. G. Hayden, 7/5,6/2; J. Wright d. B. Scott, 7/5,9/7; W. Scott d. I. Steffins, 6/1,6/2; H. Mercer d. A. Richards, 6/1,2/6,6/1; H. C. Breck d. E. W. Loeb, 3/6,1; S. Handforth d. W. Herdman, 5/7,7/5,8/6. **THIRD ROUND**—A. Pessemier d. W. Peterson, 6/3,6/1; Wickersham d. D. O. Mallet, 6/0,6/1; Wabraushek d. L. Brown, 6/3,6/7,5; H. Hahn d. W. Kautz, 6/1,6/1; Wright d. E. Pessemier, 6/8,6/3,6/3; Scott d. Mercer, 6/2,6/3; Breck d. W. White, 3/6,6/1,7/5; A. Pringle d. Handforth, 6/2,14/12. **FOURTH ROUND**—Wickersham d. A. Pessemier, 6/0,6/2; Hahn d. Wabraushek, 1/6,6/2,3; Scott d. Wright, 6/2,6/2; Breck d. Pringle, 6/4,6/3. **SEMI-FINAL ROUND**—Hahn d. Vickersham, 6/0,2/6,6/2; Breck d. Scott, 6/2,5/7,8/6. **FINAL ROUND**—Lieut. H. C. Breck d. Lieut. Herbert Hahn, 6/0,0/6,8/6,6/4.

### MEN'S DOUBLES.

**FIRST ROUND**—H. Hahn and A. Richards d. H. Phelps and Stanley Handforth, 6/0,1. **SECOND ROUND**—Wickersham and Hewitt d. Mallet and Wright, 6/4,6/3; Mercer and Brown d. A. Pessemier and Harvey, 6/1,6/3; Kautz and Hayden d. Herdman and Peterson, 6/2,6/2; Hahn and Richards d. Steffins and Stevens, 6/0,10/8; Scott and Wabraushek d. Breck and Pringle, 6/7,3/6,6/1; Flye and B. Scott d. Buffington and Kerr, 6/4,1; Neer and White d. Cabot and Graff, 6/1,6/4. **THIRD ROUND**—Wickersham and Hewitt d. Mercer and Brown, 2/6,6/2,6/3; Hahn and Richards d. Kautz and Hayden, 6/1,1/4; Scott and Wabraushek d. Sherwood and Davis, 6/0,6/0; Neer and White d. Flye and B. Scott, 6/2,6/4. **SEMI-FINAL ROUND**—Hahn and Richards d. Wickersham and Hewitt, 6/3,1/6,7/5; Scott and Wabraushek d. Neer and White, 6/4,6/4. **FINAL ROUND**—Hahn and Richards d. Scott and Wabraushek.

**PACIFIC NORTHWEST SECTIONAL DOUBLES:** First Round—White and Wright d. W. Scott and Wickersham, 4/6,2/6,7/5,6/2,6/2; Breck and Pringle d. Steffins and Neer, 0/8,6/4,8/6. Semi-final Round—Wabraushek and Brown d. White and Wright, 6/4,3/6,4/6,6/4,6/1; Breck and Pringle d. Hahn and Richards by default. Final Round—Lieut. H. C. Breck and A. Pringle d. L. Brown and R. A. Wabraushek, 4/6,6/1,1/6,7/5,6/4.

## Washington State Championships

The twenty-eighth annual Washington State championships were staged by the Seattle Lawn Tennis Club early in August, 1918. While the entry list was somewhat smaller than usual, some interesting tennis was played by the participants.

The final round of the men's singles found Mansel Smith opposed to Sa Russell, the former taking the title after four well-played sets. Mercer and Milne took the doubles honors from Neer and Russell.

Miss Sara Livingstone proved her superiority in both of the women's events. Miss Bragdon being her partner in doubles. The summaries:

#### MEN'S SINGLES.

**FIRST ROUND**—Neer d. Milne, 3/6,6/3,6/1; Fulton d. Carpenter, 6/2,6/3; White d. Kowalski, 6/2,1/6,7/5; Lausbough d. B. Bogaravlesky, 7/5,6/4; E. Wilson d. Atwood 6/4,1/6,6/4; W. Scott d. Hills, 7/5,6/2; M. Smith d. Carmichael, 6/1,6/1; L. Wilson d. Captain Gay, 6/1,7/5; Flye d. Kidwell, 6/2,6/4; Steffen d. Eberting, 6/2,6/2. **SECOND ROUND**—Neer d. Buffington, by default; White d. Fulton, 8/6,6/4; Wickersham d. Mall by default; Stevens d. Morris, 2/6,6/4,6/1; Zettler d. Lansbough, 6/0,6/2; Brownell d. I Scott, 6/3,4/6,6/4; W. Scott d. E. Wilson, 6/3,6/0; M. Smith d. Gray, 6/0,6/0; Foley d. I Wilson, 6/4,6/3; Flye d. Schlanger, 6/4,5/7,6/3; Russell d. G. Bogaravlesky, 4/6,6/4,6/7; Miller d. Wright, 10/8,0/6,8/6; Anderson d. Wabraushek, 7/5,6/3; Bemis d. Harrison, 6/6/2; Brown d. Steffen, 6/4,6/2; Mercer d. Armstrong, 6/0,8/6. **THIRD ROUND**—Neer d. White, 6/8,6/3,6/3; Wickersham d. Stevens, 6/3,7/5; Zettler d. Brownell by default; M. Smith d. W. Scott, 6/4,6/3; Flye d. Foley, 6/3,6/3; Russell d. Miller, 4/6,6/4,6/1; Anderson d. Bemis, 6/1,6/2; Mercer d. Brown, 6/4,8/6. **FOURTH ROUND**—Wickersham d. Neer 6/1,6/3; M. Smith d. Zettler, 6/1,6/2; Russell d. Flye, 6/3,6/3; Mercer d. Anderson, 6/6/1. **SEMI-FINAL ROUND**—M. Smith d. Wickersham, 6/1,6/2,2/6,9/7; Russell d. Mercer 6/4,6/2,6/1. **FINAL ROUND**—W. Mansel Smith d. Russell, 12/10,6/8,6/2,6/2.

#### MEN'S DOUBLES.

**FIRST ROUND**—Foley and Kowalski d. Atwood and Zettler, 1/6,9/7,6/1; Neer and Russell d. Carmichael and Cemistone, 6/1,6/2; Wilson and Hills d. Carpenter and Flye 7/5,6/2; Schlanger and Gray d. Captain Gay and Moser, 6/2,6/3; Mercer and Milne d. Byron Scott and Morris, 6/1,6/0. **SECOND ROUND**—Neer and Russell d. Foley and Kowalski, 6/0,4/6,6/3; Bemis and Brownell d. Wilson and Hills by default; Wabraushek and Brown d. Steinmetz and Harrison, 6/3,6/3; White and Wright d. Wickersham and Scott, 6/3,3/6,6/1; M. Smith and Anderson d. Bogaravlesky and Bogaravlesky, 6/1/6/0; Miller and LeBlonde d. Schlanger and Gray, 6/3,9/7; Mercer and Milne d. Steffen and Stevens, 6/1,6/0. **THIRD ROUND**—Neer and Russell d. Bemis and Brownell, 6/2,6/1; White and Wright d. Wabraushek and Brown, 6/2,7/5; Smith and Anderson d. Eberting and Fulton, 6/1,6/0; Mercer and Milne d. Miller and LeBlonde, 6/4,7/5. **SEMI-FINAL ROUND**—Neer and Russell d. White and Wright, 6/0,6/4,7/5; Mercer and Milne d. Smith and Anderson, 3/6,6/4,6/3,8/6. **FINAL ROUND**—Mercer and Milne d. Neer and Russell 6/4,6/3,8/6.

#### WOMEN'S SINGLES.

**FIRST ROUND**—Miss R. Hellman d. Miss M. Weiss, 6/0,6/2; Miss M. McDonald d. Mrs Weisner, 6/3,6/2; Miss C. Gondolfo d. Miss H. Greene, 6/0,6/4; Mrs. Purcell d. Mrs LeBlonde, 6/2,6/1; Mrs. Cushing d. Mrs. Hamilton, 6/2,6/1; Miss V. Benson d. Miss R. Miller, 8/6,6/1; Miss M. Wheaton d. Miss D. Greene, 6/1,6/0; Miss M. Lambuth d. Miss M. Sowie, 6/3,6/2; Miss S. Livingstone d. Mrs. Eberting, 6/0,6/0; Miss G. Schreiner d. Mrs. Milne, 6/3,6/1; Mrs. Boyd d. Miss B. Merrill, 6/0,6/1; Mrs. Fenn d. Mrs. Effinger 6/1,6/0. **SECOND ROUND**—Miss McDonald d. Miss Hellman, 6/3,6/0; Miss V. Byrne d. Miss Gondolfo, 6/3,6/3; Mrs. Cushing d. Mrs. Purcell, 6/3,6/2; Miss Wheaton d. Miss Benson, 6/0,7/6,6/3; Miss Lambuth d. Miss N. Felger by default; Miss Livingstone d. Miss D. Lindsay, 6/1,6/1; Miss Schreiner d. Miss N. Johnstone, 6/1,6/2; Mrs. Fenn d. Mrs. Boyd 6/2,6/1. **THIRD ROUND**—Miss McDonald d. Miss Byrne, 6/0,6/1; Mrs. Fenn d. Miss Wheaton, 7/5,10/8; Miss Livingstone d. Miss Lambuth, 6/3,6/1; Miss Schreiner d. Mrs Fenn, 9/7,6/3. **SEMI-FINAL ROUND**—Miss McDonald d. Mrs. Cushing, 6/3,1/6,6/4; Miss Livingstone d. Miss Schreiner, 6/1,6/0. **FINAL ROUND**—Miss Sara Livingstone d. Miss Mayme McDonald, 6/1,4/6,6/1.

#### WOMEN'S DOUBLES.

**FIRST ROUND**—Mrs. Eberting and Miss M. Lambuth d. Miss R. Miller and Miss Small, 6/1,6/3; Mrs. Milne and Mrs. Boyd d. Mrs. Purcell and Miss M. Weiss, 6/2,6/3; Mrs. Cushing and Miss M. Wheaton d. Mrs. Weisner and Mrs. Effinger, 6/0,6/0; Miss C. Gondolfo and Miss V. Byrne d. Miss D. Greene and Miss D. Lindsay, 6/3,7/5; Miss V. Benson and Miss H. Greene d. Miss B. Merrill and Miss M. Sowie, 6/1,6/2. **SECOND ROUND**—Mrs. Eberting and Miss Lambuth d. Mrs. Fenn and Miss N. Johnstone by default; Miss G. Schreiner and Miss M. McDonald d. Mrs. Milne and Mrs. Boyd, 6/1,7/5; Mrs. Cushing and Miss Wheaton d. Miss Gondolfo and Miss Byrne, 6/2,6/2; Miss Sara Livingstone and Mrs. Bragdon d. Miss Benson and Miss Greene, 6/3,6/0. **SEMI-FINAL ROUND**—Miss Schreiner and Miss McDonald d. Mrs. Eberting and Miss Lambuth, 6/2,7/5; Miss Livingstone and Mrs. Bragdon d. Mrs. Cushing and Miss Wheaton, 6/1,6/4. **FINAL ROUND**—Miss Sara Livingstone and Miss Bragdon d. Miss G. Schreiner and Miss M. McDonald, 6/3,6/2.

**MIXED DOUBLES:** Final Round—Miss Mayme McDonald and Crawford Anderson d. Miss Sara Livingstone and W. Mansel Smith, 6/0,6/2.

## Oregon State Championships

BY A. R. MUNGER.

The nineteenth annual Oregon State tournament, at the Irvington Club, Portland, July 22-27, 1918, was favored with nearly as large a list of entries and participants with fully as fine a display of tennis as in the events held during the year of peace. Whatever was lacking in the men's events due to the absence of prominent players in the service of their country, was compensated for by the appearance of several of the best of the California and Washington tennis stars, including Miss Mayme McDonald of Seattle, Mrs. Walter Ellis of Los Angeles and Mrs. J. C. Cushing of Oakland. Miss McDonald won the women's singles without the loss of a set, defeating Mrs. Ellis in a hard-fought contest, taking the final from Miss Stella Fording of Portland, 6/2,6/2. Mrs. Ellis, with G. A. Ganohl, also of Los Angeles, won the mixed doubles, and Miss McDonald paired with Mrs. Cushing took the women's doubles event. Walter A. Goss, who is one of the tennis veterans of the Northwest, scored the victory in the final of the men's singles over B. H. Wickersham of Tacoma, thereby became permanent holder of the Fiske Cup, a well known trophy with a history of twenty years' competition. Winners of the men's doubles were H. V. Cate of Portland and G. A. Ganohl. The summaries:

### MEN'S SINGLES.

FIRST ROUND—H. V. Cate d. G. Luis, Jr., 6/1,6/0; H. A. Wilkins d. H. Swett, 6/2,1; S. B. Cooke d. E. H. Smith, 6/2,6/4; P. Steffen d. H. F. Hobson, 6/2,6/3; S. A. Gam d. A. B. McAlpin, 12/10,2/6,6/4; A. D. Wakeman d. H. F. Hensch, 3/6,6/3,6/3; I. Ambrose d. R. J. Chipman, 7/5,1/6,6/3; Phil Neer d. J. B. Bilderbach, 6/3,5/4; Lew Dewey d. H. E. Thomas, 6/1,7/5; O. Lewis d. D. Witmer, 6/4,8/6; R. Gilman d. Hoffman, 6/4,9/7; G. A. Ganohl d. J. W. Moore, 6/2,6/3; A. R. Munger d. W. H. Harms, 6/2,6/3; A. D. Norris d. J. P. Mulder, 6/2,6/1; E. Johnson d. M. Parelhus, 6/2,7; F. M. Dunne d. T. Parker, 6/2,6/3. SECOND ROUND—B. H. Wickersham d. Cate, 1; J. Neer d. K. Parelhus, 6/1,6/3; H. Stevens d. Wilkins, 6/3,6/0; Cooke d. R. Gam, 6/4,7/5; A. M. Sanders d. Bingham, 6/3,6/2; Wakeman d. D. Burrell, 6/1,6/1; Neer d. Dewey, 6/4,6/3; H. S. Grey d. Gilman, 7/5,6/2; Ganohl d. Munger, 6/2,6/2; S. D. Johnson, 6/2,6/2. THIRD ROUND—Wickersham d. J. Neer, 3/6,6/2,6/1; Stevens d. Cooke, 3/6,6/4,6/4; Steffen d. Sanders, 4/6,6/2,6/3; Wakeman d. Ambrose by default; Neer d. Lewis, 6/4,8/6; Ganohl d. Grey, 6/0,2/6,7/5; Norris d. P. Cookingham, 6/2,7; W. A. Goss d. M. C. Frohman, 6/1,6/3. FOURTH ROUND—Wickersham d. Stevens, 2; Steffen d. Wakeman, 7/5,4/6,6/2; Phil Neer d. Ganohl, 6/4,6/3; Goss d. Norris, 3. SEMI-FINAL ROUND—Wickersham d. Steffen, 6/4,6/3,6/3; Goss d. Phil Neer, 6/6,3/6/3. FINAL ROUND—W. A. Goss d. B. H. Wickersham, 4/6,3/6,6/4,6/1,6/2.

### WOMEN'S SINGLES.

FIRST ROUND—Mrs. J. C. Cushing d. Miss Mary Cooper, 6/0,6/0; Mrs. Walter Ellis d. Madeline Steffen, 6/1,6/0; Miss Marion Sinclair d. Miss Adele Jones, 7/5,6/3; Miss A. Fording d. Miss Mabel Ryder, 6/3,6/2; Miss Newell d. Miss Ethel Cooper, 6/0,6/1; Irene Campbell d. Miss Lucille Bronough, 6/2,6/1; Mrs. J. P. Mulder d. Miss Inez Child, 6/0,6/3; Miss Lily Fox d. Miss Marion Weiss, 6/4,6/4; Miss Burnett d. Miss Ed Wilson, 6/4,6/4. SECOND ROUND—Mrs. Cushing d. Miss Harriett Johnson, 6/0, Mrs. Ellis d. Mrs. Wentworth, 6/0,6/0; Miss Sinclair d. Mrs. D. Witmer, 6/3,6/3; Fording d. Miss Newell, 6/4,6/4; Miss Campbell d. Mrs. Mulder, 6/2,6/3; Miss Eicher vs. McBride, 6/0,6/1; Miss Fox d. Miss Burnett, 6/1,6/2. THIRD ROUND—Miss Mayme McDonald d. Mrs. Cushing, 6/4,6/1; Mrs. Ellis d. Miss Sinclair, 6/0,6/0; Miss Fording d. Campbell, 6/4,10/8; Miss Eicher d. Miss Fox, 6/3,6/2. SEMI-FINAL ROUND—Miss McDonald d. Mrs. Ellis, 6/2,8/6; Miss Fording d. Miss Eicher, 6/1,6/2. FINAL ROUND—Miss Mayme McDonald d. Miss Stella Fording, 6/4,6/2.

Spokane Empire Championships.—From among twenty-nine entries in the singles, the Spokane Empire championship, held on the dirt courts of the Spokane (Wash.) Tennis Club, beginning June 29, 1918, narrowed down to a contest for the title between Fenwick Cady and Kenneth K. L. Simmons. The former won after a fine five-set display, 2,3/6,1/6,7/5. In the doubles, Simmons and H. W. Robinson won from W. H. Farnham and James Babb in the final round, 6/2,7/5,6/3. Miss Benrice Stult carried off the women's singles, defeating Miss Agnes Schelling in the final round, 6/0,6/2.

## Canadian Tournaments

### Ontario Championships

The Ontario championships were rendered doubly interesting last year the reason that it was the first time in the history of the competition entries outside of Canada were accepted. New York was represented by Ichikuma Kumagae, Seiichiro Kashio, Sergeant Harold A. Throckmorton and Harold Taylor, and Boston by Mrs. N. W. Niles and Miss Marion Zinderstein.

The title of champion of the Province of Ontario went to Kumagae, defeated Sergeant Throckmorton in a four-set final round. The latter and Kashio as a partner won the doubles in a hard fought four-set contest in final. The women's singles went to Miss Zinderstein and the doubles to H. Bickle and Miss Best.

In the active service singles, Sergeant Throckmorton of the U. S. Army defeated Sergeant W. Le Roy Rennie of the Canadian Army in the final, and in the doubles the honors went to Captain Bickle and Sergeant Rennie. summaries:

#### MEN'S SINGLES.

THIRD ROUND—C. D. Henderson d. Capt. E. W. Bickle, 6/1,6/4; H. L. Taylor d. G. Davidson, 6/1,7/5; T. H. Hall d. G. M. Bertram, 6/1,9/7; Ichikuma Kumagae d. P. Kane, 6/0,6/0; Seiichiro Kashio d. J. R. Boys, 6/1,6/4; R. A. Burns d. W. P. Brodie, 7/5,6/1; Sgt. H. A. Throckmorton d. W. L. Richardson, 6/1,6/3; Sgt. Rennie d. G. Brown, 6/1,6/1. FOURTH ROUND—Taylor d. Henderson, 6/3,6/4; Kumagae d. Hall, 6/0; Kashio d. Burns, 6/3,6/4; Throckmorton d. Rennie, 6/2,6/4. SEMI-FINAL ROUND—Kumagae d. Taylor, 6/1,6/2; Throckmorton d. Kashio, 4/6,6/4,6/4. FINAL ROUND—Ichikuma Kumagae d. Sgt. Harold A. Throckmorton, 6/2,6/2,4/6,6/3.

#### MEN'S DOUBLES.

THIRD ROUND—Bickle and Bickle d. Davis and Jackson, 6/3,6/1; Kumagae and Taylor d. Burns and Rennie, 6/4,6/2; Throckmorton and Kashio d. Hall and Glascoe, 8/6. SEMI-FINAL ROUND—Kumagae and Taylor d. Bickle and Bickle, 6/1,6/0; Throckmorton and Kashio d. Sykes and Knox, 6/0,6/0. FINAL ROUND—Sgt. Harold A. Throckmorton and Seiichiro Kashio d. Ichikuma Kumagae and Harold L. Taylor, 12/10,4/6,6/4,6/6.

## Toronto Patriotic Tournament

For the first time since the war began, tournament playing was resumed in Toronto, Can., sponsored by the Toronto Lawn Tennis Club and under British Cross auspices. Play began on June 29 and ended July 6, 1918. The quality of tennis displayed was, generally speaking, the best ever seen in Toronto, the attendance throughout was very large. Players from the American side of the border added materially to the interest in the competition. They included Lieut. G. F. Touchard, a member of the Royal Flying Corps stationed at Camp Borden, who came to the courts each day by plane, and Cecil and George Donaldson of New York. Among the women were Miss Molla Bjurstedt, Miss Eleonora Sears and Miss Florence Ballin. Lieutenant Touchard garnered the leading honors in the men's division, winning the open singles and the active service singles, but was defeated in the final of the mixed doubles, with Miss Sears as a partner. In the women's events, Miss Bjurstedt annexed the open singles, and, with Miss Sears, the open doubles, and also took the mixed doubles with Sergeant Rennie of Toronto as a partner. The men's doubles went to Love and Verley.

## Junior Tournaments

A few years ago junior tennis received scant courtesy at many of the clubs. To-day there are many junior players of quality, and it is mainly due to the efforts of such prominent tennis advocates as Fred B. Alexander and Julian S. Myrick that this change has been brought about.

Alexander initiated junior tennis tournaments in the metropolitan district and took a personal interest in the young players. Myrick conceived the idea of forming tennis centers throughout the United States, and through this method hundreds of boys took up the game in earnest and developed their skill.

Impetus was added to the movement by the offering of the Goddard Weld Saunders championship bowl, a massive silver trophy, gold lined. Mr. and Mrs. H. R. Saunders of New York City, who frequently accompanied their son while he was gaining tournament experience, felt that the youngsters should be given something to strive for, and the offer of the championship bowl resulted.

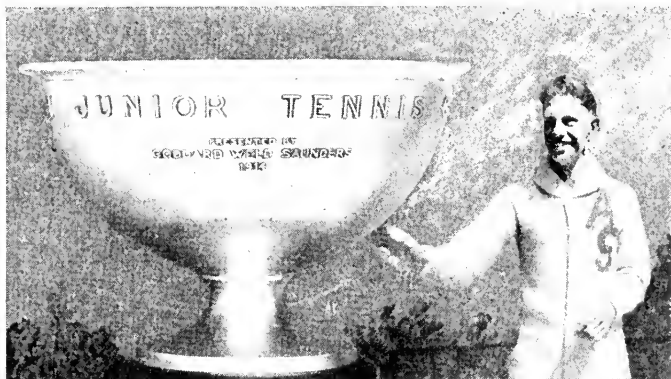

NATIONAL JUNIOR CHAMPIONSHIP TROPHY AND DONOR.

The bowl is a permanent trophy and cannot pass into the possession of any player. It was presented in 1914 by Goddard Weld Saunders, then fourteen years of age, and was originally deeded to the West Side Tennis Club as the emblem of metropolitan junior tennis championship. Two years later it was transferred by mutual agreement to the National Association, thus becoming the national trophy. This bowl was designed and executed by Black, Starr & Frost, and although purposely made with a plain surface in order to provide room for names for many years to come, its lines are graceful and beautiful, the raised lettering of the dedicatory inscription proving a fine finishing touch. The bowl measures about 16 1/2 inches across. The names of the following winners have so far been inscribed on the bowl: 1914, Harold A. Throckmorton; 1915, Charles S. Garland; 1916, Harold A. Throckmorton; 1917, Charles S. Garland; 1918, Harold L. Taylor.

The donor of this trophy is himself an enthusiastic player of great promise, having won several prizes. He is now a sophomore at Columbia and is a member of the West Side Tennis Club and other clubs.

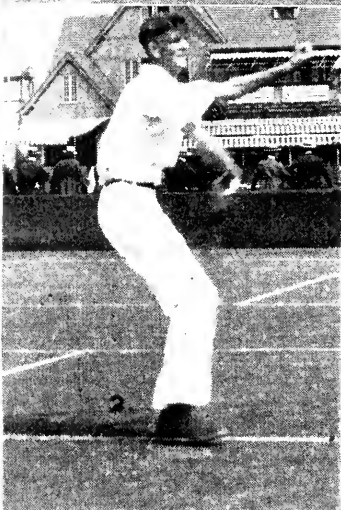
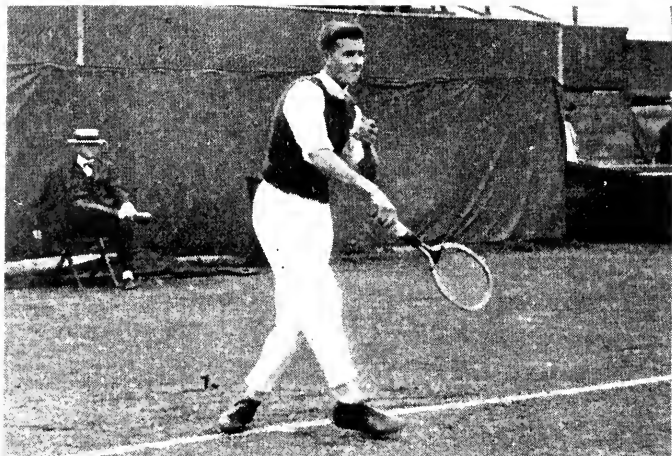

1, Harold L. Taylor, New York; National Junior Champion. 2, Fred C. Anderson, New York; Eastern New York Champion. 3, Frank T. Anderson, New York; Long Island Champion. Photos © by Corte-Scope Co., Cleveland, O.

## National Junior and Boys' Championships

The crown of junior champion of the United States fell to the lot of Harold Taylor and the boys' laurels went to Vincent Richards at the tournament held on the West Side Tennis Club's courts, Forest Hills, L. I., beginning August 25, 1918. The first national doubles championship held for juniors resulted in the success of Richards and Taylor after a four-set match in the final round with G. E. Emerson and H. Dornheim. Neither Taylor nor Hennessey, the finalists in the junior singles, played in their usual form, but in the boys' wind-up Bassford sprung quite a surprise and forced Richards to do his best. The summaries:

### JUNIOR SINGLES.

FIRST ROUND—W. J. Sweeney d. E. I. Czintz, 6/1,6/3,5/7,6/2; H. L. Taylor d. R. N. Ornheim, 6/2,6/0,6/1; G. B. Emerson d. H. J. Kaltenbach, Jr., 8/6,11/9,4/6,5/7,6/4; H. I. Dornheim d. G. B. Moreland, 6/3,6/2,6/0; F. T. Anderson d. Robert Wabraushek, 6/2,6/4,10/6,3; J. Hennessey d. H. W. Hane, 6/1,10/8,6/3; W. B. Brown d. R. Wegman, 6/2,6/1,1; E. C. Simmons d. T. Benton, 6/4,6/3,6/3. SECOND ROUND—Taylor d. Sweeney, 6/4,6/6,2/6/1; Emerson d. Dornheim, 5/7,6/4,6/2,5/7,11/9; Hennessey d. Anderson, 8/6,5/7,6/8,3,6/3; Simmons d. Brown, 6/2,4/6,6/8,7/5,6/4. SEMI-FINAL ROUND—Taylor d. Emerson, 3,6/4,6/3; Hennessey d. Simmons, 6/2,6/2,6/4. FINAL ROUND—Harold L. Taylor d. J. Hennessey, 6/4,6/2,6/2.

### BOYS' SINGLES.

FIRST ROUND—E. T. Osgood d. Jack Dudley, 7/5,6/4,6/1; Vincent Richards d. William Ingraham, 6/0,6/0,6/1; C. P. Watson d. K. M. Boyd, 6/4,7/5,8/6. SEMI-FINAL ROUND—Bassford, 3d. d. Osgood, 6/2,6/2,6/1; Richards d. Watson, 6/2,6/2,6/4. FINAL ROUND—Vincent Richards d. A. Bassford, 3d. 6/2,9/7,7/5.

### JUNIOR DOUBLES.

FIRST ROUND—A. H. Chapin, Jr., and G. Chapin d. Fischer and A. Bassford, 3d. 2,3/6,6/4,7/5; Vincent Richards and Harold Taylor d. E. D. Cumming and R. Wabraushek, 6/3,6/2,6/4. SECOND ROUND—C. Watson and F. T. Osgood d. W. Sweeney and A. Donaldson, 2/6,6/4,6/2,8/6; G. B. Emerson and H. Dornheim d. Chapin and Chapin, 6/3,4,4/6,6/2; Richards and Taylor d. J. Hennessey and H. W. Hane, 6/1,2/6,4/6,6/4,7/5; F. T. Anderson and Cecil Donaldson d. E. W. Simmons and W. Osgood, 6/3,6/1,6/4. SEMI-FINAL ROUND—Emerson and Dornheim d. Watson and Osgood, 6/3,6/1,6/3; Richards and Taylor d. Donaldson, 6/0,10/8,6/3. FINAL ROUND—Vincent Richards and Harold Taylor d. G. E. Emerson and H. Dornheim, 6/3,6/3,6/6,3.

## National Indoor Junior and Boys' Championships

A high class field of juniors and boys participated in the second annual national indoor championships, held by the Seventh Regiment Tennis Club of New York at the armory, December 23-28, 1918. Vincent Richards won the junior singles title by defeating Frank T. Anderson in a thrilling five-set match, three of which went to deuce. Richards suffered a setback in the doubles, however, for with H. L. Taylor as a partner, the pair lost to Anderson and H. B. Kaltenbach in five sets. This was a combined event for juniors and boys. The boys' singles resulted in a victory for M. Bernstein, who had quite an easy task to win from Leo Jandorf in the final round. The summaries:

### JUNIOR SINGLES.

FIRST ROUND—H. B. Kaltenbach d. Sheppard Alexander, 6/1,6/2; L. B. Dailey, Jr., d. W. Herman, 6/2,6/1; H. L. Taylor d. M. E. Macksoud, 6/1,6/0; S. H. Frey d. F. P. Wittke, 6/3,6/1; Frank T. Anderson d. Henry Brunnice, 6/0,6/1; L. Lefkowitz d. V. O. Lea, 8/6,6/0; G. B. Emerson d. E. P. Veldran, 6/0,6/2; W. E. Osgood d. J. B. Morse, 6/4,6/2; H. G. Snow d. F. Pawley, 6/4,6/2; A. Bachrach d. James Ballish, 6/2,6/2; T. S. Gros d. C. E. Unterberg, 6/3,6/3; Vincent Richards d. J. Gardiner, 6/3,6/2; Warren Slattery d. H. M. Snow, 6/1,6/3; Percy Kynaston d. H. Greef, 6/1,6/0. SECOND ROUND—Kaltenbach d. Dailey, 6/2,6/4; Taylor d. Frey, 6/0,5/7,6/1; Anderson d. L. Lefkowitz, 1,6/2; Emerson d. Samuel Sanberg, 6/2,6/1; A. Bassford, 3d. d. Osgood, 8/6,7/5; Snow d. Bachrach, 6/0,8/6; Richards d. Le Gros, 6/3,6/2; Kynaston d. Slattery, 6/1,6/2. THIRD

ROUND—Kaltenbach d. Taylor, 6/3,8/6; Anderson d. Emerson, 6/2,6/2; Bassford d. Snow 6/1,6/2; Richards d. Kynaston, 6/0,6/3. SEMI-FINAL ROUND—Anderson d. Kaltenbach 6/4,6/4; Richards d. Bassford, 6/3,6/2. FINAL ROUND—Vincent Richards d. Frank T. Anderson, 4/6,10/8,7/5,5/7,6/4.

#### JUNIOR AND BOYS' DOUBLES.

FIRST ROUND—Macksoud and Ballish d. Noble and Roullion, 6/4,6/0. SECOND ROUND—Emerson and Bassford d. Snow and Gardiner, 6/3,6/1; Osgood and Osgood d. Porter and Tucker, 6/4,6/2; Anderson and Kaltenbach d. Mathey and Veldran, 6/3,6/2; Pawley and Greef d. Macksoud and Ballish, 8/6,6/2; Taylor and Richards d. Bernstein and Kuhn, 6/2,7/5; Kynaston and Le Gros d. Unterberg and Bachrach, 6/0,6/3; Cowan and Winston d. Snow and Shafer, 6/2,6/2. THIRD ROUND—Emerson and Bassford d. Osgood and Osgood, 6/0,6/4; Anderson and Kaltenbach d. Morse and Frey by default; Taylor and Richards d. Pawley and Greef, 6/0,6/4; Kynaston and Le Gros d. Cowan and Winston 6/0,6/0. SEMI-FINAL ROUND—Anderson and Kaltenbach d. Emerson and Bassford, 6/4,6,7/5; Taylor and Richards d. Kynaston and Le Gros, 6/4,6/0. FINAL ROUND—Frank T. Anderson and H. B. Kaltenbach d. H. L. Taylor and Vincent Richards, 3/6,4/6,6/6,6/4,7/5.

#### BOYS' SINGLES.

FIRST ROUND—Leo Jandorf d. F. Winston, 6/1,7/5; C. C. Vail d. L. Roullion, 1/6,6/2; J. J. Tucker, 2d, d. L. R. Comfort, 6/0,6/1; E. Dawson d. W. L. Osgood, 7/5,6/2; Jerry Lang d. Sampson Markett, 6/1,6/2; S. Cowan d. H. W. Leland, 10/8,6/2; M. Bernstein d. E. Kuhn, 6/3,6/1. SECOND ROUND—Stanley Noble d. W. M. Warner, 6/0,7/8/6; Jandorf d. John Bissell, 6/3,6/2; Paul McHugh d. H. Bachrach, 6/4,6/1; Vail d. Tucker, 7/5,2/6,6/1; Lang d. Dawson, 1/6,6/0,9/7; Bernstein d. Cowan, 7/5,4/6,6/3; L. Dailey, Jr., d. C. F. Mathey, 6/1,6/0. THIRD ROUND—Jandorf d. Noble, 6/0,6/0; Vail McHugh, 6/3,6/3; Bernstein d. Lang, 7/5,5/7,6/4; Dailey d. Landau, 6/1,6/0. SEMI-FINAL ROUND—Jandorf d. Vail, 6/2,6/3; Bernstein d. Dailey, 3/6,6/0,6/1. FINAL ROUND—Bernstein d. Leo Jandorf, 6/3,6/2,6/1.

## Metropolitan Junior and Boys' Championships

Frank T. Anderson was the illuminating star in the Metropolitan championships for juniors and boys, which were decided on the dirt courts of the Tennis Club of Brooklyn, N. Y., July 8 to 13, 1918. He had very little to spare however, when he won from Cecil Donaldson in the final round of singles after the hottest kind of a five-set match. These youngsters made a formidable doubles combination, taking the measure of the clever Gerald B. Emerson and Harold Taylor in straight sets. The final round of the boys' singles resulted in another splendid contest, Steve Schlessinger pulling out in front of Sheridan Gibney. The summaries:

#### JUNIOR SINGLES.

FIRST ROUND—Gerald Emerson d. David Herrmann, 6/1,6/2; Gerald Donaldson, Jr., H. A. Winsten, 6/2,6/3; Frank Rosenthal d. Walter Zareko, 6/3,6/2; J. Ewing d. Harold Brunl, 10/8,6/4; Frank T. Anderson d. Edward Rogers, 6/0,6/1; Alfred Bacharach d. Ewing, 10/8,6/4; Cecil Donaldson d. J. J. Balesh, 6/3,6/2; Ned Cumming d. A. G. Post 6/3,6/3; Albert Silverman d. Travers Le Gros, 6/4,2/6,8/6; A. M. Tarson d. S. C. Beggs 6/1,6/4; Harold Taylor d. M. E. Macksoud, 6/2,6/2. SECOND ROUND—Emerson d. P. Kynaston, 6/3,6/4; G. Donaldson d. Lionel Lefkowitz, 6/2,6/3; Rosenthal d. J. Ewing by default; Anderson d. Bacharach, 10/8,6/2; C. Donaldson d. Cumming, 6/3,6/4; A. Silverman d. A. M. Tarson, 6/4,6/3. THIRD ROUND—Emerson d. G. Donaldson, 6/3,6/2; Anderson d. Rosenthal, 6/2,6/0; C. Donaldson d. A. F. Lynch, 6/1,6/2; Taylor d. A. Silverman 6/0,6/4. SEMI-FINAL ROUND—Anderson d. Emerson, 6/4,6/3; C. Donaldson d. Taylor 8/6,1/6,8/6. FINAL ROUND—Frank T. Anderson d. Cecil Donaldson, 9/7,4/6,6/2,5/7,6/3.

#### JUNIOR DOUBLES.

FIRST ROUND—Cecil Donaldson and Frank T. Anderson d. Lefkowitz and Schlessinger, 6/3,6/4; Gerald Donaldson, Jr., and Lynch d. A. B. Sheridan and Stoddart, 6/6/1; Emerson and Taylor d. M. E. Macksoud and Balesch, 6/0,6/0. SECOND ROUND—E. Whalen and D. Titterton d. Kynaston and Silverman, 3/6,8/6,6/4; Cecil Donaldson and Anderson d. R. Clark and N. Wyckoff, 6/4,6/2; Rosenthal and B. Brownold d. Gerald Donaldson and Lynch by default; Emerson and Taylor d. Le Gros and partner by default. SEMI-FINAL ROUND—Donaldson and Anderson d. Whalen and Titterton, 6/6/1; Emerson and Taylor d. Rosenthal and Brownold, 6/1,6/0. FINAL ROUND—Cecil Donaldson and Frank T. Anderson d. Gerald B. Emerson and Harold Taylor, 6/3,6/4,6/4.



## BOYS' SINGLES.

FIRST ROUND—F. A. Walsh d. Ogdan Phipps, 7/5,6/4; Sheridan Gibney d. Harry Bruni, 4/6,6/3,6/3. SECOND ROUND—Steve Schlessinger d. Stuart Gayness, 6/0,6/0; George Titus d. Walsh, 6/2,6/0; Gibney d. William Boise by default; Mathew Lamport d. Thomas Van Kuyck, Jr., 7/5,6/0; F. A. Winsten d. L. R. Crawford, 7/5,3/6,8/6; Jerome Lang d. A. B. Sheridan, 8/6,2/6,6/1. THIRD ROUND—Schlessinger d. Kenneth Stoddard, 6/3,6/2; Titus d. Abraham Bassford, 3d, by default; Gibney d. Lamport, 11/9,6/0; Lang d. Winsten, 6/3,6/1. SEMI-FINAL ROUND—Schlessinger d. Titus, 10/8,1/6,8/6; Gibney d. Lang, 7/5,6/4. FINAL ROUND—Steve Schlessinger d. Sheridan Gibney, 6/3,6/4,4/6,5/7,6/1.

## Metropolitan Girls' Junior Championships

Miss Helen Rice, a promising young player possessing good strokes and form, won the first annual Metropolitan junior championship for girls, held at the West Side Tennis Club, Forest Hills, N. Y., beginning May 18, 1918. Miss Rice was successful in the doubles also, being teamed with Miss Winifred Aydelotte. The meeting was in charge of a committee consisting of Miss Florence A. Ballin, chairman, and the Misses Helen Rice, Elizabeth Guiler and Eunice Rossman. The summaries:

## GIRLS' SINGLES.

FIRST ROUND—Miss Winifred Aydelotte d. Miss Emeline Hayward, 6/0,6/1; Miss Louise Kreuter d. Miss Edith Guiler, 6/4,12/10; Miss Nina Goldstein d. Miss Celeste Chandler, 6/0,6/1; Miss Helen Rice d. Miss Eunice Rossman, 6/2,6/0; Miss Janet Travell d. Miss Virginia Bell, 6/4,6/2. SECOND ROUND—Miss Aydelotte d. Miss Kreuter, 6/2,6/1; Miss Ruth Goldsmith d. Miss Goldstein, 6/2,6/3; Miss Rice d. Miss Travell, 6/3,3/6,6/2; Miss Joy Hansel d. Miss Helen Jenkins, 6/1,6/2. SEMI-FINAL ROUND—Miss Aydelotte d. Miss Goldsmith, 6/4,6/3; Miss Rice d. Miss Hansel, 6/4,6/2. FINAL ROUND—Miss Helen Rice d. Miss Winifred Aydelotte, 6/2,6/2.

## GIRLS' DOUBLES.

FIRST ROUND—Miss Margaret Morrey and Miss Helen Jenkins d. Miss Margaret Goldsmith and Miss Justine Wise, 11/13,6/0,7/5; Miss Rice and Miss Aydelotte d. Miss Hildegarde Ross and Miss Ruth Goldsmith, 6/8,6/4,6/3; Miss Mary Jessup and Miss Louise Kreuter d. Miss Virginia Bell and Miss Ruth Rapoport, 4/6,6/4,6/1. SEMI-FINAL ROUND—Miss Rice and Miss Aydelotte d. Miss Morrey and Miss Jenkins, 6/1,6/2; Miss Jessup and Miss Kreuter d. Miss Eunice Rossman and Miss Edith Guiler, 6/2,7/5. FINAL ROUND—Miss Helen Rice and Miss Winifred Aydelotte d. Miss Mary Jessup and Miss Louise Guiler, 6/3,6/2.

## Metropolitan Girls' Open Tournament

A new event for girls of the Metropolitan district who had not reached their nineteenth birthday was held at the West Side Tennis Club on October 12 and 13, 1918. The presence of influenza affected the entry list, and in order to obviate defaults the draw was not made until the morning of play.

The playing of Miss Helen Rice was the feature of the tournament, as she not only won the singles handily, but in conjunction with Miss Ceres Baker took the doubles in rather easy fashion. The summaries:

## GIRLS' SINGLES.

FIRST ROUND—Miss Helen Rice d. Miss Ceres Baker, 6/4,6/2; Miss Doris Goss d. Miss M. Dunningham, 6/2,6/3; Miss Eunice Rossman d. Miss Helen Donahue, 8/6,6/3; Miss Adelaide Hooker d. Miss Betty Baker, 4/6,6/4,8/6. SEMI-FINAL ROUND—Miss Rice d. Miss Goss, 6/1,6/0; Miss Hooker d. Miss Rossman, 6/4,6/1. FINAL ROUND—Miss Helen Rice d. Miss Adelaide Hooker, 6/1,6/1.

## GIRLS' DOUBLES.

FIRST ROUND—Miss Helen Donahue and Miss M. Dunningham d. Miss Alice Postley and Miss Dorothy Fox, 3/6,6/3,6/4. SEMI-FINAL ROUND—Miss Adelaide Hooker and Miss Betty Baker d. Miss Donahue and Miss Dunningham, 6/2,6/1; Miss Helen Rice and Miss Ceres Baker d. Miss Doris Goss and Miss D. Wagner, 6/0,6/3. FINAL ROUND—Miss Helen Rice and Miss Ceres Baker d. Miss Adelaide Hooker and Miss Betty Baker, 6/3,6/2.



opponents in the final round, which went to Osgood, 6/3,6/4,6/3. By winning, Pleasantville has two legs on the Association Cup, presented by C. C. Paulding, while Mount Vernon and Yonkers High Schools have one each. The summaries:

#### JUNIOR SINGLES.

FIRST ROUND—Welles Kintner (Irvington) d. A. de Paszthory (Peekskill), 4/6,6/4,6/2; Dick Hering (Irvington) d. Leonard Shiman (Mt. Vernon), 6/2,6/4; Henry Leland (Mt. Vernon) d. F. T. Osgood (Pleasantville), 6/8,6/3,6/3; Trenor Young (Pleasantville) d. T. A. Hellwig (Peekskill), 6/1,6/1; F. E. O'Callaghan, Jr. (Mamaroneck), d. S. B. Quackenbush (Peekskill), 7/5,6/3; Harold Gladwin (Mt. Vernon) d. Charles Bohmert (Mamaroneck), 6/1,6/3. SECOND ROUND—W. E. Osgood (Pleasantville) d. Kintner, 6/0,6/0; Hering d. Leland, 13/11,7/5; Young d. O'Callaghan, 6/2,6/1; Gladwin d. Allan McMartin (Irvington), 6/3,6/1. SEMI-FINAL ROUND—Osgood d. Hering, 6/2,6/0; Young d. Gladwin, 6/1,6/4. FINAL ROUND—W. E. Osgood d. Trenor Young, 6/3,6/4,6/3.

## Yale Interscholastic Championship

Twenty-six Connecticut schoolboys took part in the Yale interscholastic championship, which was decided on the Hillhouse courts at New Haven, May 18, 1918. Lewis Morrow of the Choate School for Boys, Wallingford, won the premier honors by defeating Bennett of Bridgeport High School in the final round, in straight sets. Milholland of Choate School won the consolation singles from Lienhard of Hartford High School, 8/6,6/3. The summary:

FIRST ROUND—Laiden (Hartford) d. Williams (Hopkins), 6/1,6/1; Hoskins (Hartford) d. McCance (New Haven), 6/4,6/4; Wheeler (Gunnery) d. R. Buechler (Bridgeport), 6/2, 6/1; Bennett (Bridgeport) d. Hedberg (Crosby), 6/1,6/1; Stoner (Hopkins) d. Mohnkern (Crosby), 7/5,6/1; Hartzmark (Hartford) d. Balestro (Gunnery), 3/6,6/3,6/3; Dodge (Crosby) d. Allison (Bridgeport), 6/2,6/0; Foster (Bridgeport) d. W. J. Moran (Crosby), 10/8,1/6,6/4; J. Moran (Crosby) d. W. B. Smith (Gunnery), 2/6,6/4,5/6. SECOND ROUND—Snider d. Milholland (Choate), 7/5,2/6,6/3; Hoskins d. Mooney (Hopkins), 6/4,6/3; Bennett d. Wheeler, 6/1,6/4; Stoner d. Leinhard (Hartford), 6/2,7/5; Tremaine (Gunnery) d. Hartzmark, 6/1,6/1; Dodge d. Foster, 4/6,6/4,6/0; Lewis Morrow d. J. Moran, 3/6,6/3,6/0; F. Smith (Crosby) d. P. Buechler (Bridgeport), 6/4,6/3. THIRD ROUND—Bennett d. Stoner, 6/3,6/1; Tremaine d. Dodge, 6/0,6/1; Morrow d. F. Smith, 6/3,6/1; Snider d. Hoskins by default. SEMI-FINAL ROUND—Bennett d. Snider, 6/3,6/4; Morrow d. Tremaine, 8/6,6/1. FINAL ROUND—Lewis Morrow (Choate) d. Bennett (Bridgeport), 6/3,6/2.

## Longwood Junior and Boys' Championships

The third annual junior and boys' championships of the Longwood Cricket Club were held on the club's grounds at Chestnut Hill and the play throughout was interesting. George Scott of Waban, Mass., won the junior honors, defeating Francis Plimpton of Walpole, Mass., in straight sets in the final round. The boys' event went to Arnold M. Jones quite handily. The summaries:

#### JUNIOR SINGLES.

FIRST ROUND—George C. Guild d. D. P. Robinson, Jr., 7/5,6/1; George Scott d. W. R. Holmes, 7/5,6/3; J. D. E. Jones, Jr., d. M. P. Baker, 6/1,6/1; Bradlee Smith d. F. S. Williams, 6/3,6/2; Karl S. Pfaffman d. F. M. Seamans, Jr., 6/0,6/1; Francis Plimpton d. Barrett Hurwitz, 6/3,3/6,8/6; A. H. Richardson d. George W. Mandell, 6/3,6/2. SECOND ROUND—J. D. Davis d. T. Adamowski, 6/0,6/0; Guild d. Carl Gray, 6/0,6/4; Scott d. Jones, 8/6,6/2; Jackson d. Smith, 7/5,6/2; Plimpton d. Pfaffman, 6/3,6/3; Richardson d. Henri Junod, 6/3,6/1. THIRD ROUND—Scott d. Guild, 6/0,7/5; Plimpton d. Jackson, 6/2, 5/7,6/1; Richardson d. S. H. Howe, 6/3,6/1. SEMI-FINAL ROUND—Scott d. Davis, 6/2, 6/3; Plimpton d. Richardson, 4/6,7/5,6/3. FINAL ROUND—George Scott d. Francis Plimpton, 6/1,8/6.

#### BOYS' SINGLES.

FIRST ROUND—Albert W. Leavitt d. R. W. Lapham, 6/1,6/4; J. M. White d. A. M. Persons, 4/6,7/5,6/2; A. H. Smith d. T. J. Holmes, 6/2,6/2; Donald M. Hill, Jr., d. E. R. Nash, Jr., 6/0,6/0. SECOND ROUND—R. Nichols d. George H. Perkins, 6/2,6/2; Leavitt d. White, 6/1,6/0; Smith d. Hill, 6/0,7/5; Arnold M. Jones d. Alden Briggs, 6/4,8/6. SEMI-FINAL ROUND—Leavitt d. Nichols, 7/5,6/3; Jones d. Smith, 6/4,6/2. FINAL ROUND—Arnold M. Jones d. Albert W. Leavitt, 6/2,6/1.

## Southern Junior and Boys' Championships

The 1918 Southern junior and boys' championships were held by the City of Atlanta (Ga.) Tennis Club at Piedmont Park during the week of July 15 and many hard fought matches resulted. I. Czintz had no difficulty in winning the junior singles, being a class above the other contestants, while Edwin Everett proved himself the best of the boys. The summaries:

### JUNIOR SINGLES.

FIRST ROUND—Egbert Wright d. Carlyle Holleman, 6/4,6/2; I. Czintz d. Jack Corry, 6/2,6/1; Joel Rankin d. Lewis Newman, 6/1,9/11,6/2; Ed Holliday d. Sonny Lateur, 6/1,6/0; Ab Silver d. Alfred Blalock, 4/6,7/5,6/4. SECOND ROUND—Czintz d. Rankin, 6/2,6/4; E. Blalock d. Wright, 6/4,5/7,6/4; E. Newman d. Holliday, 6/2,5/7,6/2; Charles Courtney d. Silver, 6/2,4/6,6/3. SEMI-FINAL ROUND—Czintz d. Blalock, 6/0,6/1; Courtney d. Newman, 7/5,3/6,6/2. FINAL ROUND—I. Czintz d. Charles Courtney, 6/2,6/0,6/0.

### BOYS' SINGLES.

FIRST ROUND—Jack Ross d. Robert Hix, 6/1,6/0; Robert Clements d. Charleton Bidwell, 9/7,5/7,6/3; Edwin Everett d. Jack Elnore, 6/1,8/6. SEMI-FINAL ROUND—Clements d. Ross, 6/4,6/1; Everett d. Harry Cannon, 6/2,6/4. FINAL ROUND—Edwin Everett d. Robert Clements, 6/2,10/8,6/2.

## St. Louis Junior and Boys' Championships

The tennis center championships for juniors and boys, held under the auspices of the St. Louis Amateur Athletic Association, beginning June 22, 1918, resulted in some good play between the youngsters. Val Satterfield won the junior singles from Clyde Baessler in the final round, while the boys' singles went to S. Sommer in a four-set final. The summaries:

### JUNIOR SINGLES.

FIRST ROUND—H. Hibschnann d. E. Mullineut, 4/6,9/7,6/1; Satterfield d. Brown, 6/0,1/6,8/6; Morton d. Goodwin, 6/2,6/3; Baessler d. Sommer, 1/6,6/3,6/1; Storer d. Schneck, 6/3,6/4; Perrine d. D. Murphy, 8/6,1/6,6/0. SECOND ROUND—A. Sodermann d. Hibschnann, 6/4,6/3; Satterfield d. Morton, 6/4,7/5; Baessler d. Kammann, 6/3,6/2; Storer d. Perrine by default. SEMI-FINAL ROUND—Satterfield d. Sodermann, 6/3,6/4; Baessler d. Storer by default. FINAL ROUND—Val. Satterfield d. Clyde Baessler, 6/4,6/3,6/4.

### BOYS' SINGLES.

FIRST ROUND—H. Gould d. D. Morton, 6/2,6/0; S. Sommer d. R. Tenney, 8/6,2/6,6/3. SECOND ROUND—L. Cooper d. Paul Baker, 6/0,6/1; Gould d. Schenck, 6/0,6/1; Sommer d. Landecker, 6/0,6/0; James Epstein d. David J. Ross, 7/5,3/6,6/3. SEMI-FINAL ROUND—Gould d. Cooper, 6/0,6/1; Sommer d. Epstein, 6/0,6/0. FINAL ROUND—S. Sommer d. H. Gould, 6/2,4/6,6/4,6/2.

## Kansas City Junior Championships

Young tennis players had an enjoyable week's sport on the Kansas City Field Club's courts when the Kansas City tennis center junior championships were decided. Ernest Primm carried off the junior singles honors, but Cecil Soldanels made him play every inch of the way in the final round. Kenneth Dubach won the boys' singles, while the girls' title went to Miss Martha McLendon. The summaries:

### JUNIOR SINGLES.

FIRST ROUND—Walter Hausman d. J. S. Goodell, 6/3,6/2; Jerome Jacobson d. Milford Linneman, 4/6,6/1,6/3; C. A. Ferguson d. Nathan Appleman, 6/4,6/0; Lyddon Gilman d. Herbert A. Sac, 6/3,6/0; Wilson Riley d. George Paulette, 6/3,6/4; Wallace Kunz d. Howard Beck, 6/0,6/1; W. H. Ferguson, Jr., d. Given Helms, 7/5,6/4; Earl Holderbaum d. B. K. Smoot, 6/1,7/5. SECOND ROUND—Kenneth Dubach d. Hausman, 6/2,6/1; Soldanels d. Jankuson, 6/4,6/1; Schmitz d. Jacobson, 6/1,6/1; C. A. Ferguson d. Gilman, 6/2,

8/10,6/3; Merrill Dubach d. Riley, 6/2,8/6; Kunz d. Owen Biggs, 6/3,6/0; Holderbaum d. W. H. Ferguson, Jr., 6/1,6/2. THIRD ROUND—Soldanels d. K. Dubach, 7/5,6/2; Schmitz d. C. A. Ferguson by default; M. Dubach d. Kunz, 6/2,6/3; Ernest Primm d. Holderbaum, 6/1,6/2. SEMI-FINAL ROUND—Soldanels d. Schmitz, 6/4,6/4; Primm d. M. Dubach, 6/4,2/6,12/10. FINAL ROUND—Ernest Primm d. Cecil Soldanels, 7/5,9/7.

## BOYS' SINGLES.

FIRST ROUND—Nathan Appleman d. W. H. Ferguson, Jr., 6/3,6/3; Walter Hausman d. Howard Peck, 6/4,7/5; Kenneth Dubach d. Owen Biggs, 6,3,6/2. SECOND ROUND—Appleman d. Helms, 7,5,3,6,6/4; Gilman d. Hausman, 6,1,1/6,6,0; Dubach d. Milford Linneman, 6,2,6/1. SEMI-FINAL ROUND—Appleman d. Jacobson, 6/3,6/3; Dubach d. Gilman, 4/6,6/3. FINAL ROUND—Kenneth Dubach d. Nathan Appleman, 6/3,7,5.

## GIRLS' SINGLES.

FIRST ROUND—Miss Martha McLendon d. Miss Annabel Mogan, 2/6,6/4,6/4. SECOND ROUND—Miss Catherine Cannon d. Miss Marjorie Kerner, 6,4,6/0; Miss McLendon d. Miss Edwina Higgins, 6/4,6,0; Miss Elizabeth Forrester d. Miss Norma Miller, 7/5,6/2. SEMI-FINAL ROUND—Miss Cannon d. Miss Higgins, 6/4,6/1; Miss McLendon d. Miss Forrester, 6/3,6/3. FINAL ROUND—Miss Martha McLendon d. Miss Catherine Cannon, 6/4,6/3.

## Pacific Coast Junior Championships

The competition for the junior championships of the Pacific Coast was held in connection with the men's and women's tournament at the Berkeley (Cal.) Tennis Club, beginning June 15, 1918. The winner of the singles title, Mervyn Griffin, showed that he was the best junior player on the Coast. The doubles was won by Howard Kinsey and William Parker, but only after five hard sets in the final round with Mervyn Griffin and Wilton Smith.

For the first time a Pacific Coast girls' junior tournament was held, and some pretty tennis was the result, every one of the sets being closely contested. Miss Johanna Gunzburger was the star, playing a splendid brand of the net game. The summaries:

## JUNIOR SINGLES.

FIRST ROUND—T. Martin d. Alan Shapley, 6,3,6/0; A. Ross d. H. Merkle, 6/3,6/0. SECOND ROUND—W. Smith d. C. Smith, 3,6,6/4,8,6; Parker d. Martin, 6/2,6,2; Kinsey d. Ross, 7/5,6/3; Griffin d. Bettens, 6/1,8,10,6,3. SEMI-FINAL ROUND—Parker d. W. Smith, 8,10,6/4,6/4; Griffin d. Kinsey, 2,6,9/7,6,3. FINAL ROUND—Mervyn Griffin d. William Parker, 6/0,6/3.

## JUNIOR DOUBLES.

FIRST ROUND—Kinsey and Parker d. C. Smith and Bettens, 6/1,6,4. FINAL ROUND—Howard Kinsey and William Parker d. Mervyn Griffin and Wilton Smith, 4/6,6/3, 6/4,3/6,7/5.

## GIRLS' SINGLES.

FIRST ROUND—Miss J. Gunzburger d. Miss Helen Law, 6/3,6/4; Miss Helen Newman d. Miss Aileen Egan, 6/4,8,6. SEMI-FINAL ROUND—Miss Gunzburger d. Miss Hilliard, 6/4,6/2; Miss Newman d. Miss B. Creghino, 10,12,8,6,7/5. FINAL ROUND—Miss Johanna Gunzburger d. Miss Helen Newman, 6/4,6/1.

## Oregon Junior and Boys' Tournament

Juniors and boys and junior girls had a very successful meeting at the Multnomah Amateur Athletic Club of Portland, beginning June 5, 1918. Philip Neer won the junior singles, while the boys' singles was taken by Corwin Bufington. Miss Harriet Johnson won the girls' singles, but only after quite a hard struggle with Miss Inez Fairchild. The summaries:

## JUNIOR SINGLES.

THIRD ROUND—Philip Neer d. George Goldstein, 6/1,6/2; Paul Steffen d. H. Stevens, 6/4,2/6,13/11; Kenneth Smith d. Selwyn Bingham, 6/4,6/3; H. Westerman d. Robert Gil-

man, 7/5,6/3. SEMI-FINAL ROUND—Neer d. Steffen, 5/7,6/1,6/4,6/3; Westerman d. Smith, 6/4,6/4,3/6,6/3. FINAL ROUND—Philip Neer d. H. Westerman, 6/2,6/2,6/4.

#### BOYS' SINGLES.

THIRD ROUND—Corwin Buffington d. Brazil Baird, 6/1,6/1; Ed Durham d. I. Westerman, 6/4,6/4; R. Dubois d. Malcolm Ringer, 6/2,6/3. SEMI-FINAL ROUND—Buffington d. Arens, 6/0,6/1; Durham d. Dubois by default. FINAL ROUND—Corwin Buffington d. Ed Durham, 6/1,6/1,6/2.

#### JUNIOR GIRLS' SINGLES.

THIRD ROUND—Miss Lenora Stone d. Miss Marion Gloyd, 4/6,6/3,6/3; Miss Harriet Johnson d. Miss Marion Weiss, 6/3,6/2; Miss Mildred Wilson d. Miss Dorothy Manville, 6/1,6/1. SEMI-FINAL ROUND—Miss Inez Fairchild d. Miss Lenora Stone, 6/4,7/7 (default); Miss Johnson d. Miss Wilson, 3/6,6/4,6/1. FINAL ROUND—Miss Harriet Johnson d. Miss Inez Fairchild, 2/6,7/5,6/4.

**Iron Mountain Junior Tournament.**—W. Ingraham outplayed the rest of the juniors in the Iron Mountain tournament, held by the Iron Mountain Lawn Tennis Club of Jackson, N. H., during the week of August 5, 1918. Ingraham easily defeated Samuel Elder in the final round. The summary: First round—W. Ingraham d. Scranton Redfield, 6/1, 6/0; A. Ingraham d. Barlow Burke, 6/4,2/6,6/3; Samuel Elder d. Charles Kalbarch, 10/8, 6/4; Parker Huntington d. Kendall Hodgdon, 6,2,6/1. Semi-final round—W. Ingraham d. A. Ingraham, 6/4,6/2; Elder d. Huntington, 6/4,4/6,9/7. Final round—W. Ingraham d. Samuel Elder, 6/0,6/0.

**East Side of White Mountains Junior Championship.**—A small but vigorous field of youngsters participated in the 1918 competition for the championship of the East Side of the White Mountains on the courts of the Iron Mountain Tennis Club, Jackson, N. H., during the first week in August. J. D. Ewing, after a sterling five-set match with W. Herbert Abbott, won. The summary: First round—W. Ingraham d. Scranton Redfield, 6/1,6/0. Second round—A. Ingraham d. Barlow Burke, 6/4,2,6,6/3; Samuel Elder d. Charles Kalbarch, 10,8,6/4; Parker Huntington d. Kendall Hodgdon, 6,2,6/1. Semi-final round—W. Ingraham d. A. Ingraham, 6,4,6/2; Elder d. Huntington, 6/4,4,6,9/7. Final round—W. Ingraham d. Samuel Elder, 6/0,6/0.

**Woodmere Club Junior Tournament.**—The first annual junior tournament of the Woodmere Club, Woodmere, N. Y., was an interesting and successful affair. Vincent Richards and Frank T. Anderson had a battle royal in the final round of singles, Richards winning after dropping the first two sets. Another severe clash took place in the final of the doubles, Anderson and Cecil Donaldson just pulling through in a five-set match. The summaries: Junior Singles: Semi-final round—Vincent Richards d. Gerald Emerson, 6/1, 6/4; Frank T. Anderson d. Harold Taylor, 6/1,6/4. Final round—Vincent Richards d. Frank T. Anderson, 6/8,5/7,6/4,6/0,6/1. Junior Doubles: Semi-final round—Emerson and Bassford d. Taylor and Richards, 1/6,7/5,6/4; Anderson and Donaldson d. Rabinowitz and Unterberg by default. Final round—Frank T. Anderson and Cecil Donaldson d. Gerald Emerson and Abraham Bassford, 3d, 6/2,4/6,6/8,8/6,7/5.

**Buffalo (N. Y.) Junior and Boys' Championships.**—Coles Wadsworth defeated a field of ambitious youngsters from the Western New York high schools in the junior singles of the Buffalo Center championships, while Hansauer was the best of the boys. The tournament took place at the Park Club during the week of June 24, 1918. Summaries: Junior Singles: Semi-final round—Weyand (Masten) d. Rupp (Lafayette), 6/2,4/6,11/9; Wadsworth d. Boeock, 5,7,6/4,7/5. Final round—Wadsworth d. Weyand, 6/4,6/2. Boys' Singles: Semi-final round—Hansauer d. Grabau, 6,2,7/9,7/5; Rupp d. Klinek, 6/3,6/1. Final round—Hansauer d. Rupp, 6/4,5/7,6/3.

**Atlantic City (N. J.) Junior Championship.**—Junior players disported themselves very well in the tournament for the Atlantic City (N. J.) championship, held on the courts of the Atlantic City Yacht Club, July 29, 1918. Gerald B. Emerson of East Orange, N. J., emerged with the honors, defeating Goddard Saunders in straight sets in the final round. The summaries: First round—Gerald B. Emerson d. Richard Horstman, 6/3, 6/1. Semi-final round—Goddard Saunders d. John Wack, 6/2,6/1; Emerson d. Louis Winch, 6/0,6/0. Final round—Gerald B. Emerson d. Goddard Saunders, 6/2,6,2,6/3.

**Westfield (N. J.) Junior Championship.**—Lyman L. Tremaine easily won the singles in the 1918 tournament for the junior championship, held by the Westfield Golf Club of Westfield, N. J. The summaries: First round—Joseph Moore d. Edgar Reeve, 6/0,6/0; William Taylor d. Russell Welch, 6,0,6/4. Second round—Goddard W. Saunders d. A. Seed, 6/0,6/0; G. Moore d. G. Carr, 9/7,1/6 (default). Semi-final round—Saunders d. Joseph Moore, 6/4,6/0; Lyman L. Tremaine d. William R. Taylor, 6/0,6/1. Final round—Lyman L. Tremaine d. Goddard W. Saunders, 6/3,6/1,6/1.

**New Jersey Coast Boys' Championship.**—Harold Cook had an easy task in winning the boys' championship of the New Jersey Coast, which was decided in connection with the men's competition on the courts of the Bay Head Yacht Club, August 28, 1918. The summaries: First round—Richard Rush d. Drake DeLony, 6/1,7/5; J. R. Devereux d. D. M. Duffield, 6/2,6/2; Harold Cook d. C. J. Wells, 6/2,6/0; Harold Brewster d. Blake Bent, 6/0,6/1. Semi-final round—Devereux d. Rush, 7/5,6/3; Cook d. Brewster, 6/0,6/1. Final round—Harold Cook d. J. R. Devereux, 6/0,6/0.

**Philadelphia Roof Court Junior Tournament.**—A strong aggregation of junior players contested in the Philadelphia and District Lawn Tennis Association tournament on the two board courts on the roof of the John Wanamaker store in March, 1919. Vincent Richards was never in trouble in the singles, winning easily from Rodney M. Beck in the final, 6/3,6/3,6/3. These players, paired in the doubles, outclassed the field, and in the final defeated E. R. March and Milo Miller of Penn Charter School, Philadelphia, 6/3,6/0,6/4.

**Edgewood (Pa.) Junior and Boys' Championships.**—The courts of the Edgewood Club of Pittsburgh, Pa., abounded in some lively play on June 1, 1918, when the junior and boys' championships of Edgewood were decided. Charles Smail won the junior singles from George R. Moreland, Jr., in the final of a four-set match, and Kier Boyd defeated Alan A. Garland, the youngest members of that Pittsburgh family, in the final of the boys' competition. The summaries: Junior Singles: Semi-final round—Charles Smail d. George Marshall, 6/3,1/6,6/3; George R. Moreland d. William Campbell, 6,1,6/0. Final round—Charles Smail d. George B. Moreland, Jr., 6/3,3,6,6,0,6/4. Boys' Singles: Semi-final round—Kier Boyd d. McMillan, 6,2,6/2; Alan A. Garland d. William McLain, 6/0,6/2. Final round—Kier Boyd d. Alan A. Garland, 6,1,6/3,6/2.

**Interstate Junior Championship.**—Junior players did not turn out in very large numbers at the third annual Interstate championship, under the auspices of the Interstate Tennis Club of Sioux City, Iowa, beginning August 7, 1918. The youngsters, however, made up for their small attendance by a creditable display of tennis and furnished some sharp contests for the honors. Jack Moore and W. Gooch had a lively scrap for the honors in the title round, the former getting the verdict after a 11/9 second set. The summary: Semi-final round—W. Gooch d. A. Lennon, 6/3,6/4; Jack Moore d. Burton Ford, 6/1,6/1. Final round—Jack Moore d. W. Gooch, 6/4,11,9.

**Northwestern Interscholastic Championships.**—The seventeenth annual tournament for the Northwestern interscholastic championship, held on June 7 and 8, 1918, attracted a good field of players and keen sport was the result. Leslie Johnson of the Minneapolis Central High School carried off the individual honors of the meet, defeating John Farman of St. Paul Academy in the final round, 6,1,7/5,6/6,5/7,6/3. The point score was as follows: Minneapolis Central High, 4; West High, St. Paul Central High and St. Paul Academy, 3 each; East High, 2.

**Los Angeles (Cal.) Boys' Championships.**—Harold Godshall, after a stirring contest with Ralph Stillwell, won the singles, and Gifford Troyer and Fred Ephlin won the doubles in the Los Angeles city championships for boys. The summaries: Singles: First round—Paul Russell d. John Olmstead, 2/6,6/1,6/4; Tony Vasquez d. William Davies, 6/0,6/4. Final round—Harold Godshall d. Ralph Stillwell, 6/4,10/8. Doubles: First round—Smith and Miller d. Vasquez and Shelton, 6/2,6/0; Stillwell and Olmstead d. Russell and Farrall, 5/7,9/7,6/3. Second round—Troyer and Ephlin d. Smith and Miller, 6/3,6/3; Stillwell and Olmstead d. Godshall and Kinsler, 2/6,7/5,8,6. Final round—Troyer and Ephlin d. Stillwell and Olmstead, 6/3,7/5.

**Pacific Northwest Junior and Boys' Championships.**—The junior and boys' championships of the Pacific Northwest, held in connection with the men's and women's championships at Tacoma during the week of July 29, 1918, brought out some excellent tennis. Unfortunately there were only three entries in the boys' event, Lewiston and Spokane having no representatives. In the latter competition Corwin Bullington of Portland won. The summaries: First round—R. A. Wabraushek d. W. White, 7/5,6,0,7/5. Semi-final round—J. Wright d. B. Scott, 6,1,7/5,6/3; Wabraushek d. P. Neer, 6/4,1,6,2/6,6/4,6/3. Final round—R. A. Wabraushek d. J. Wright, 6/4,6/3,6/4.

**Seattle (Wash.) Junior Tournament.**—Robert Wabraushek showed himself to be much the best player in the junior tournament held by the Seattle Tennis Club, beginning June 3, 1918. He displayed an excellent game, having a good serve, a fast drive, and net work of more than ordinary skill. The summary: Semi-final round—C. Hills d. W. Nollan by default; R. Wabraushek d. M. Schlanger, 6/4,9/7. Final round—Robert Wabraushek d. C. Hills, 6,2,6/3.

## Ranking Committee's Report

*To the Executive Committee of the United States National Lawn Tennis Association:*

Herewith your committee presents class lists in men's singles and men's doubles for players and teams who participated in three or more tennis tournaments during the season of 1918.

By request of the California Lawn Tennis Association, Pacific Coast players not participating in Eastern tournaments were not classed. By unanimous consent of the Ranking Committee a few players were classed who participated in the national championship and one other tournament. Please note the arrangement in classes as directed by the new rules.

For the information of the Executive Committee, in addition to the class grouping we have given the computed rating and relative number (based on rating) of each player or team listed. In view of the fact that the ratings and relative positions have been determined by the law of averages and have not been left to the guesses or vague opinions of our committee, we deplore the fact, if it is a fact, that the actual number and rating of each player may not be published as well as his classing.

It is worthy of note that while the difference of one or two points in rating generally does not indicate a difference in class, it is always well in competitive sport to recognize the better record.

For your further information we hand you a brief summary of our methods of arriving at a player's rating, together with tentative rules, tables, etc.

In harmony with the 1916 Ranking Committee's recommendations, we suggest the appointment of a committee to draw rules and regulations as to the several variables to be used, such as weight of tournaments, unfitness of contestants, difference of rating for various scores, etc. Upon the determination of certain standards of comparison, all players judged by these standards will be on an equal basis and the results should be satisfactory.

The labors of the Ranking Committee for 1918 have been greatly reduced by the efficient methods of the Field Secretary's office in collecting and arranging data for our consideration.

The committee wishes to thank the Women's Ranking Committee, composed of Mrs. William H. Pouch, chairman; Miss Edith B. Handy and Mrs. Benjamin E. Cole, for its efficient aid.

Respectfully submitted,

WALTER T. HAYES,  
CONRAD B. DOYLE,  
PAUL W. GIBBONS,  
HARRY C. JOHNSON,  
ABRAHAM BASSFORD, JR., Chairman.  
PAUL B. WILLIAMS, Secretary.

A minority report was presented by Paul W. Gibbons, it differing from the majority report only in giving No. 1 position to W. T. Tilden, Jr.



SUGGESTED RULES FOR DETERMINATION OF TENNIS RATING FOR ANY PLAYER.

1. Players to be considered are first placed in their *approximate class*, e., 0-10, 10-20—to 90-100.
2. Using the *approximate class* list and rating tables (appended) rating for each representative match should be computed. However, in no case shall the computed difference in rate for any match exceed by 20 points the difference shown in the established *approximate class*.
3. The average rating for each tournament played may then be computed.
4. The year's *prime rate* may then be computed by averaging the player's tournament ratings and giving the established weight for each tournament.
5. The "weight" given to tournament ratings in the *general average* is to be as follows:

|                                   |   |
|-----------------------------------|---|
| (a) National Championship .....   | 4 |
| (b) Clay Court Championship.....  | 3 |
| (c) *Sectional Championship ..... | 2 |
| (d) Other tournaments .....       | 1 |

\*Southampton, Newport, etc., are considered as sectional championships.

6. *Final rating* may then be established by using the aforementioned methods together with the "prime rating" instead of the "approximate rating" as a basis for estimating.

NOTES.

- A. The approximate class is generally determined from previous ranking lists and knowledge of a player's ability.
- B. The prime rate ordinarily will be sufficient to determine a player's rank. However, when two players are very evenly matched, their relative standing must be determined by a second rating as explained in Rule 6.

RATING TABLES.

(Best in three-set matches.)

(Best in five-set matches.)

|  |  |
|--|--|
| <p>— 5 Class—Win 1 set and total<br/>                  games = opponents —2.</p> <p>—10 Class—Win 1 set or total<br/>                  games = 10.</p> <p>—20 Class—Win 8 games.</p> <p>—30 Class—Win 6 games.</p> <p>—40 Class—Win 4 games.</p> <p>—50 Class—Win 2 games.</p> | <p>— 5 Class—Win 1 set and total<br/>                  games = opponents —4.</p> <p>—10 Class—Win 15 games.</p> <p>—20 Class—Win 12 games.</p> <p>—30 Class—Win 9 games.</p> <p>—40 Class—Win 6 games.</p> <p>—50 Class—Win 3 games.</p> |
|--|--|

At the meeting of the Executive Committee of the U.S.N.L.T.A. held February 7, 1919, Mr. Bassford, chairman of the Ranking Committee, brought up the question of readjusting the ranking of A. P. Hubbell of Chicago, at the request of Mr. Hayes.

It was suggested that Mr. Hubbell be placed in the same class with Edward Oelsner, especially as the Western Association had ranked these men and placed them about as suggested.

It was recommended that Mr. Hubbell be placed No. 24 instead of 19, and Mr. Oelsner 25. That action reduced Class 7 to four men and increased Class 8 to eight players. The recommendation was approved.

# Official Rankings for 1918

## MEN'S SINGLES

### CLASS 1

1. R. Lindley Murray, Niagara Falls, N. Y.
2. William T. Tilden, Jr., Philadelphia

### CLASS 2

3. Fred B. Alexander, New York

### CLASS 3

4. Walter Merrill Hall, New York
5. Walter T. Hayes, Chicago
6. Nathaniel W. Niles, Boston

### CLASS 4

7. Ichiya Kumagae, New York
8. Charles S. Garland, Pittsburgh
9. S. Howard Voshell, Brooklyn, N. Y.
10. Theodore R. Pell, New York

### CLASS 5

11. R. H. BURDICK.....Chicago
12. C. B. DOYLE.....Washington, D. C.
13. H. C. JOHNSON.....Boston

### CLASS 6

14. L. E. MAHAN.....New York
15. CRAIG BIDDLE.....Philadelphia
16. SAMUEL HARDY.....Chicago
17. SEIICHIRO KASHIO.....New York
18. H. A. THROCKMORTON.....Elizabeth, N. J.

### CLASS 7

19. E. H. BINZEN.....New York
20. R. N. DANA.....Pawtucket, R. I.
21. VINCENT RICHARDS.....New York
22. C. A. MAJOR.....New York

### CLASS 8

23. THEODORE DREWES.....St. Louis
24. A. P. HUBBELL.....Chicago
25. EDWARD OELSNER.....Chicago
26. R. C. SEAVER.....Boston
27. F. C. BAGGS.....New York
28. G. A. L. DIONNE.....New York
29. C. Y. SMITH.....Atlanta
30. WALTER WESTBROOK.....Detroit

### CLASS 9

31. H. H. HODGE.....Buffalo
32. A. J. VEYSEY.....Montreal, Can.
33. HEATH MOORE.....Kansas City
34. T. W. HENDRICK.....Buffalo
35. E. V. CARTER.....Atlanta
36. HAROLD L. TAYLOR....Brooklyn, N. Y.
37. HENRY C. WICK, JR.....Cleveland

## CLASS 10

|                        |                  |
|------------------------|------------------|
| P. B. HAWK.....        | Philadelphia     |
| K. B. UHLS.....        | Kansas City      |
| GEORGE KING.....       | Scarsdale, N. Y. |
| N. W. SWAYNE.....      | Philadelphia     |
| F. C. ANDERSON.....    | Brooklyn, N. Y.  |
| F. T. ANDERSON.....    | Brooklyn, N. Y.  |
| E. H. HENDRICKSON..... | Haworth, N. J.   |
| P. S. OSBORNE.....     | Philadelphia     |

## CLASS 11

|                            |                      |
|----------------------------|----------------------|
| DR. WILLIAM ROSENBAUM..... | New York             |
| C. G. BURROWS.....         | Brooklyn, N. Y.      |
| CHARLES CHAMBERS.....      | Brooklyn, N. Y.      |
| H. H. BASSFORD.....        | Pleasantville, N. Y. |
| I. F. HARTMAN.....         | New York             |
| H. H. MANCHESTER.....      | New York             |
| H. J. STEINKAMPF.....      | New York             |
| P. W. GIBBONS.....         | Philadelphia         |
| J. A. COLLOM.....          | Stamford             |

## CLASS 12

|                       |                      |
|-----------------------|----------------------|
| H. B. O'BOYLE.....    | Pelham Naval Station |
| GEORGE O'CONNELL..... | Chicago              |
| MILTON ACAY.....      | Chicago              |
| PHILIP BAGBY.....     | Kansas City          |

## CLASS 13

|                       |                   |
|-----------------------|-------------------|
| J. McGEE.....         | St. Paul          |
| L. H. Waidner.....    | Chicago           |
| C. T. SPEICE.....     | Kingfisher, Okla. |
| EMBREE HENDERSON..... | New York          |
| G. W. MINOR.....      | Cleveland         |

## CLASS 14

|                        |                     |
|------------------------|---------------------|
| FENMORE CADY.....      | Cœur d'Alene, Idaho |
| JOHN HENNESSEY.....    | Indianapolis        |
| ROBERT WABRAUSHEK..... | Seattle             |
| J. P. BENSON.....      | Chicago             |
| H. L. BOWMAN.....      | New York            |
| W. A. WHITE.....       | Lewiston, Idaho     |
| F. P. FOX.....         | Hartsdale, N. Y.    |
| A. S. CASSILS.....     | Montreal, Can.      |
| T. C. FULTON.....      | Seattle             |
| L. F. GILBERT.....     | Buffalo             |
| C. H. RASEMAN.....     | Detroit             |
| HOWARD PENFOLD.....    | Kansas City         |
| PERRY SEGAL.....       | Chicago             |
| K. L. R. SIMMONS.....  | Butte, Mont.        |
| ALAN BEHR.....         | Yonkers, N. Y.      |
| LINDSAY DUNHAM.....    | Newark, N. J.       |
| W. M. FISCHER.....     | New York            |

## CLASS 15

|                            |                      |
|----------------------------|----------------------|
| 81. W. U. KNIGHT.....      | Minneapolis          |
| 82. FRANK MIDDLEDITCH..... | Westfield, N. J.     |
| 83. E. F. THOMAS.....      | Pelham Naval Station |
| 84. J. S. O'BOYLE.....     | Pelham Naval Station |
| 85. J. S. EHLERS.....      | Minneapolis          |
| 86. ALEX. ILER.....        | Pelham Naval Station |
| 87. DR. MORGENTHALER.....  | Brooklyn, N. Y.      |
| 88. G. H. SICARD.....      | Utica, N. Y.         |
| 89. W. H. ABBOTT.....      | Boston               |
| 90. J. D. EWING.....       | Yonkers, N. Y.       |
| 91. PAUL MARTIN.....       | New York             |
| 92. R. D. RICHEY.....      | Brooklyn, N. Y.      |
| 93. DR. W. H. ROSS.....    | Brooklyn, N. Y.      |
| 94. ABRAHAM BASSFORD.....  | 30, Hartsdale, N. Y. |
| 95. A. W. MERRIAM.....     | Farmington, Conn.    |

## CLASS 16

|                            |                     |
|----------------------------|---------------------|
| 96. W. H. BENEDICT.....    | Belmar, N. J.       |
| 97. W. TOUSSAINT.....      | Bedford Park, N. Y. |
| 98. R. F. WOODS.....       | Chicago             |
| 99. HARRY SACHS.....       | New York            |
| 100. LOCK WEI.....         | Cambridge, Mass.    |
| 101. VINTON VERNON.....    | Cleveland           |
| 102. GEORGE GROESBECK..... | New York            |

## CLASS 17

|                            |                      |
|----------------------------|----------------------|
| 103. H. R. HATHAWAY.....   | New York             |
| 104. EDWIN SHEAFE.....     | Boston               |
| 105. J. B. HUGHES.....     | Pelham Naval Station |
| 106. J. P. STOCKTON.....   | Spring Lake, N. J.   |
| 107. R. M. BECK.....       | Philadelphia         |
| 108. H. B. BROOCKMANN..... | Forest Hills, N. Y.  |
| 109. A. H. CHAPIN.....     | Springfield, Mass.   |
| 110. A. H. CHAPIN, JR..... | Springfield, Mass.   |
| 111. E. S. CHASE.....      | Pittsfield, Mass.    |
| 112. DR. B. F. DRAKE.....  | New Rochelle, N. Y.  |
| 113. GERALD EMERSON.....   | Orange, N. J.        |
| 114. R. A. ENGLAND.....    | Chicago              |
| 115. F. A. FALL.....       | Crestwood, N. Y.     |
| 116. F. E. ADAMS.....      | Atlantic City, N. J. |

## CLASS 18

|                           |                    |
|---------------------------|--------------------|
| 117. HERMAN DORNHEIM..... | Philadelphia       |
| 118. E. C. SIMMONS.....   | Los Angeles        |
| 119. R. L. JAMES.....     | Saratoga, N. Y.    |
| 120. G. W. PIKE.....      | Springfield, Mass. |
| 121. CARL FISHER.....     | Philadelphia       |
| 122. W. B. BROWN.....     | St. Louis          |

## CLASS 19

|                           |                 |
|---------------------------|-----------------|
| 123. CECIL DONALDSON..... | Brooklyn, N. Y. |
| 124. S. S. PENNOCK.....   | Philadelphia    |

## MEN'S DOUBLES

### CLASS 1

1. W. T. Tilden, Jr., and Vincent Richards.
2. F. B. Alexander and B. C. Wright

### CLASS 2

3. N. W. Niles and T. R. Pell

### CLASS 3

4. C. S. Garland and Samuel Hardy
5. W. T. Hayes and R. H. Burdick

### CLASS 4

6. I. C. Wright and H. C. Johnson
7. I. Kumagae and H. L. Taylor

### CLASS 5

8. E. H. Binzen and J. S. O'Boyle
9. B. M. Grant and Nat Thornton
10. Walter Westbrook and R. L. James

### CLASS 6

- |   |                                    |
|---|------------------------------------|
| 11. H. J. STEINKAMPF and H. H. BASS-FORD. | 12. SEIICHIRO KASHIO and ALAN BEHR |
|   | 13. ALEX. ILER and H. B. O'BOYLE.  |

### CLASS 7

- |  |                                    |
|--|------------------------------------|
| 14. E. J. PAGE and L. F. BAKER.            | 17. LOCK WEI and H. B. BROOCKMANN. |
| 15. A. BASSFORD, Jr., and A. BASSFORD, 3d. | 18. W. H. BENEDICT and EDWARD RA   |
| 16. A. H. CHAPIN and A. H. CHAPIN, Jr.     | DALL.                              |

### CLASS 8

- |                                     |                                      |
|-------------------------------------|--------------------------------------|
| 19. J. S. O'BOYLE and E. F. THOMAS. | 21. K. B. UHLS and PHILIP BAGBY.     |
| 20. H. B. O'BOYLE and J. B. HUGHES. | 22. H. L. TAYLOR and F. T. ANDERSON. |

### CLASS 9

23. G. H. SICARD and E. F. TORREY.

## WOMEN'S RANKING

In presenting its report the Women's Ranking Committee, composed of M. W. H. Pouch, Miss Edith B. Handy and Mrs. B. E. Cole, expressed regret that at least two extremely promising players on the Pacific Coast were not considered. This was in conformity with the request of the California Lawn Tennis Association that those who did not play in Eastern tournaments be omitted from the ranking.

It is to be regretted that so many players of national fame must be omitted even from the list of those not ranked on account of insufficient data, but owing to the fact that they have played in no tournaments the committee had no choice in the matter.

Miss Molla Bjurstedt has again achieved first honors, there being no close second to her record of victories, which included the following tournaments: Pelham, Ardsley, Metropolitan, Longwood, Western Pennsylvania, Great Lakes, New Jersey, Heights Casino indoor, national indoor and national championship, challenge round.

The following are mentioned as "not ranked on account of insufficient data": Miss Mary K. Browne, Los Angeles; Miss Natalie Browning, Tarrytown; Mrs. B. F. Briggs, Pelham Manor, N. Y.; Mrs. B. O. Bruce, Los Angeles; Miss Alice Drake, St. Paul; Miss Sara Livingstone, Seattle; Miss Mayme McDonald, Seattle; Miss Irving Murphy, New Orleans; Mrs. Edward Raymond, Hartsdale, N. Y.; Miss Evelyn Seavey, Kansas City; Miss Florence Sutton, Los Angeles.

In view of the fact that the women's ranking had been made according to the old system and not according to the classes established by a vote at the annual meeting, a readjustment of the women's ranking to make it conform to the system used in ranking the men was approved. It was voted to recommend to the annual meeting the following ranking for the women:

## CLASS 1

1. Miss Molla Bjurstedt, New York
2. Mrs. George W. Wightman, Boston

## CLASS 2

3. Mrs. Homer Stuart Green, Tarrytown, N. Y.
4. Miss Eleanor Goss, New York
5. Miss Marie Wagner, New York

## CLASS 3

6. Miss Carrie B. Neely, Chicago
7. Miss Corinne Gould, St. Louis

## CLASS 4

8. Miss Helene Pollak, New York
9. Miss Edith B. Handy, Tompkinsville, N. Y.
10. Miss Clare Cassel, New York

## CLASS 5

11. MRS. JACK RAMESON.....Los Angeles
12. MISS ELEONORA SEARS .....Boston
13. MRS. RAWSON WOOD.....New York
14. MISS MARION ZINDERSTEIN.....Boston

## CLASS 6

15. MRS. JOHANN ROGGE.....New York
16. MRS. S. F. WEAVER.....New York
17. MRS. MALCOLM McNEILL.....Chicago
18. MISS FLORENCE BALLIN.....New York
19. MRS. DAVID C. MILLS.....Orange, N. J.
20. MISS RUTH WISE.....Cleveland

## CLASS 7

21. MRS. THEODORE CASSEBEER...New York
22. MRS. E. V. LYNCH.....New York
23. MISS CAROMA WINN.....New York
24. MISS BESSIE HOLDEN.....New York

## CLASS 8

25. MRS. PERCY WILBOURNE.....New York
26. MISS MARION LEIGHTON.....Chicago

## CLASS 9

27. MISS KATHERINE WALDO.....Chicago
28. MISS M. CHESNEY.....Phoenix, Ariz.

180 SPALDING'S LAWN TENNIS ANNUAL.

# Ranking of First Ten Players Since 1885

- 1885—1. R. D. Sears; 2. J. Dwight; 3. W. V. R. Berry; 4. G. M. Brinley; 5. J. S. Clark; 6. A. Moffat; 7. R. L. Beeckman; 8. H. A. Taylor; 9. F. S. Mansfield; 10. W. P. Knapp.
- 1886—1. R. D. Sears; 2. J. Dwight; 3. R. L. Beeckman; 4. H. A. Taylor; 5. J. S. Clark; 6. H. W. Slocum; 7. G. M. Brinley; 8. F. S. Mansfield; 9. A. Moffat; 10. J. S. Conover.
- 1887—1. R. D. Sears; 2. H. W. Slocum; 3. R. L. Beeckman; 4. H. A. Taylor; 5. J. S. Clark; 6. F. S. Mansfield; 7. P. S. Sears; 8. G. M. Brinley; 9. E. P. MacMullen; 10. Q. A. Shaw, Jr.
- 1888—1. H. W. Slocum; 2. H. A. Taylor; 3. J. Dwight; 4. J. S. Clark; 5. C. A. Chase; 6. P. S. Sears; 7. E. P. MacMullen; 8. O. S. Campbell; 9. R. L. Beeckman; 10. F. S. Mansfield.
- 1889—1. H. W. Slocum; 2. Q. A. Shaw, Jr.; 3. O. S. Campbell; 4. H. A. Taylor; 5. C. A. Chase; 6. J. S. Clark; 7. W. P. Knapp; 8. R. P. Huntington, Jr.; 9. P. S. Sears; 10. F. S. Mansfield.
- 1890—1. O. S. Campbell; 2. R. P. Huntington, Jr.; 3. W. P. Knapp; 4. H. W. Slocum; 5. F. H. Hovey; 6. C. Hobart; 7. P. S. Sears; 8. H. A. Taylor; 9. C. A. Chase; 10. V. G. Hall.
- 1891—1. O. S. Campbell; 2. C. Hobart; 3. R. P. Huntington, Jr.; 4. F. H. Hovey; 5. E. L. Hall; 6. V. G. Hall; 7. P. S. Sears; 8. S. T. Chase; 9. C. T. Lee; 10. M. D. Smith.
- 1892—1. O. S. Campbell; 2. E. L. Hall; 3. W. P. Knapp; 4. C. Hobart; 5. F. H. Hovey; 6. W. A. Larned; 7. M. G. Chace; 8. R. D. Wrenn; 9. R. Stevens; 10. C. P. Hubbard.
- 1893—1. R. D. Wrenn; 2. C. Hobart; 3. F. H. Hovey; 4. M. G. Chace; 5. W. A. Larned; 6. E. L. Hall; 7. R. Stevens; 8. A. E. Foote; 9. John Howland; 10. C. R. Budlong.
- 1894—1. R. D. Wrenn; 2. W. A. Larned; 3. M. F. Goodbody; 4. F. H. Hovey; 5. M. G. Chace; 6. C. Hobart; 7. R. Stevens; 8. C. R. Budlong; 9. A. E. Foote; 10. W. G. Parker.
- 1895—1. F. H. Hovey; 2. W. A. Larned; 3. M. G. Chace; 4. John Howland; 5. R. D. Wrenn; 6. C. B. Neel; 7. C. Hobart; 8. R. Stevens; 9. A. E. Foote; 10. C. R. Budlong.
- 1896—1. R. D. Wrenn; 2. W. A. Larned; 3. C. B. Neel; 4. F. H. Hovey; 5. E. P. Fischer; 6. G. L. Wrenn, Jr.; 7. R. Stevens; 8. M. D. Whitman; 9. L. E. Ware; 10. G. P. Sheldon, Jr.
- 1897—1. R. D. Wrenn; 2. W. A. Larned; 3. W. V. Eaves; 4. H. A. Nesbit; 5. H. S. Mahony; 6. G. L. Wrenn, Jr.; 7. M. D. Whitman; 8. Kriegh Collins; 9. E. P. Fischer; 10. W. S. Bond.
- 1898—1. M. D. Whitman; 2. L. E. Ware; 3. W. S. Bond; 4. D. F. Davis; 5. C. R. Budlong; 6. E. P. Fischer; 7. G. L. Wrenn, Jr.; 8. R. Stevens; 9. S. C. Millett; 10. G. K. Belden.
- 1899—1. M. D. Whitman; 2. D. F. Davis; 3. W. A. Larned; 4. J. P. Paret; 5. Kriegh Collins; 6. G. L. Wrenn, Jr.; 7. Leo Ware; 8. Beals C. Wright; 9. Holcombe Ward; 10. R. P. Huntington, Jr.
- 1900—1. M. D. Whitman; 2. D. F. Davis; 3. W. A. Larned; 4. Beals C. Wright; 5. Kriegh Collins; 6. G. L. Wrenn, Jr.; 7. Holcombe Ward; 8. L. E. Ware; 9. J. A. Allen; 10. R. D. Little.
- 1901—1. W. A. Larned; 2. Beals C. Wright; 3. D. F. Davis; 4. L. E. Ware; 5. C. Hobart; 6. R. D. Little; 7. H. Ward; 8. Kriegh Collins; 9. E. P. Fischer; 10. W. J. Clothier.
- 1902—1. W. A. Larned; 2. M. D. Whitman; 3. Beals C. Wright; 4. Holcombe Ward; 5. W. J. Clothier; 6. L. E. Ware; 7. R. D. Little; 8. H. H. Hackett; 9. Clarence Hobart; 10. Kriegh Collins.
- 1903—1. W. A. Larned; 2. Holcombe Ward; 3. W. J. Clothier; 4. Beals C. Wright; 5. Kriegh Collins; 6. E. P. Larned; 7. H. F. Allen; 8. E. W. Leonard; 9. R. H. Carleton; 10. Kenneth Horton.
- 1904—1. Holcombe Ward; 2. W. J. Clothier; 3. W. A. Larned; 4. Beals C. Wright; 5. Kriegh Collins; 6. R. D. Little; 7. F. B. Alexander; 8. R. Stevens; 9. A. E. Bell; 10. E. W. Leonard.

1905—1. B. C. Wright; 2. Holcombe Ward; 3. W. A. Larned; 4. W. J. Clothier; 5. Frederick B. Alexander; 6. Clarence Hobart; 7. Richard Stevens; 8. Kriegh Collins; 9. R. D. Little; 10. F. G. Anderson.

1906—1. W. J. Clothier; 2. W. A. Larned; 3. B. C. Wright; 4. F. B. Alexander; 5. K. H. Behr; 6. R. D. Little; 7. H. H. Hackett; 8. F. G. Anderson; 9. E. B. Dewhurst; 10. I. C. Wright.

1907—1. W. A. Larned; 2. B. C. Wright; 3. Karl H. Behr; 4. R. D. Little; 5. Robert LeRoy; 6. Clarence Hobart; 7. E. P. Larned; 8. R. C. Seaver; 9. Irving C. Wright; 10. F. C. Colston.

1908—1. W. A. Larned; 2. B. C. Wright; 3. F. B. Alexander; 4. W. J. Clothier; 5. R. D. Little; 6. Robert LeRoy; 7. Nat Emerson; 8. N. W. Niles; 9. W. F. Johnson; 10. R. H. Palmer.

1909—1. W. A. Larned; 2. W. J. Clothier; 3. W. F. Johnson; 4. N. W. Niles; 5. R. D. Little; 6. M. E. McLoughlin; 7. M. H. Long; 8. Karl H. Behr; 9. E. P. Larned; 10. Robert LeRoy.

1910—1. W. A. Larned; 2. T. C. Bundy; 3. B. C. Wright; 4. M. E. McLoughlin; 5. M. H. Long; 6. N. W. Niles; 7. G. F. Touchard; 8. T. R. Pell; 9. F. C. Colston; 10. C. R. Gardner.

1911—1. W. A. Larned; 2. M. E. McLoughlin; 3. T. C. Bundy; 4. G. F. Touchard; 5. M. H. Long; 6. N. W. Niles; 7. T. R. Pell; 8. R. D. Little; 9. K. H. Behr; 10. W. M. Hall.

1912—1. M. E. McLoughlin; 2. R. Norris Williams, 2nd; 3. Wallace F. Johnson; 4. W. J. Clothier; 5. N. W. Niles; 6. T. C. Bundy; 7. K. H. Behr; 8. R. D. Little; 9. C. R. Gardner; 10. G. F. Touchard.

1913—1. M. E. McLoughlin; 2. R. Norris Williams, 2nd; 3. W. J. Clothier; 4. W. M. Johnston; 5. T. R. Pell; 6. N. W. Niles; 7. W. F. Johnson; 8. G. F. Touchard; 9. G. P. Gardner, Jr.; 10. J. R. Strachan.

1914—1. M. E. McLoughlin; 2. R. Norris Williams, 2nd; 3. Karl H. Behr; 4. R. L. Murray; 5. W. J. Clothier; 6. W. M. Johnston; 7. G. M. Church; 8. Fred B. Alexander; 9. W. M. Washburn; 10. E. F. Fottrell.

1915—1. W. M. Johnston; 2. R. Norris Williams, 2nd; 3. M. E. McLoughlin; 4. Karl H. Behr; 5. T. R. Pell; 6. N. W. Niles; 7. C. J. Griffin; 8. W. M. Washburn; 9. G. M. Church; 10. W. Merrill Hall.

1916—1. R. Norris Williams, 2nd; 2. W. M. Johnston; 3. G. M. Church; 4. R. L. Murray; 5. Ichiya Kumagae; 6. C. J. Griffin; 7. W. M. Washburn; 8. W. E. Davis; 9. J. J. Armstrong; 10. Dean Mathey.

1918—1. R. L. Murray; 2. W. T. Tilden, Jr.; 3. F. B. Alexander; 4. W. M. Hall; 5. W. T. Hayes; 6. N. W. Niles; 7. Ichiya Kumagae; 8. C. S. Garland; 9. S. H. Voshell; 10. T. R. Pell.

## WOMEN'S RANKING SINCE 1913.

1913—1. Miss Mary Browne; 2. Mrs. B. O. Bruce; 3. Miss Florence Sutton; 4. Mrs. Marshall McLean; 5. Mrs. Robert Williams; 6. Miss Marie Wagner; 7. Mrs. Benjamin F. Briggs (Dorothy Green); 8. Miss Edith E. Rotch; 9. Miss Anita Myers; 10. Miss Gwendolyn Rees.

1914—1. Miss Mary Browne; 2. Miss Florence Sutton; 3. Miss Marie Wagner; 4. Mrs. Edward Raymond; 5. Miss Edith Rotch; 6. Miss Eleonora Sears; 7. Mrs. Robert Williams; 8. Mrs. David Wood; 9. Mrs. H. A. Niemeyer; 10. Miss Sara Livingston.

1915—1. Miss Molla Bjurstedt; 2. Mrs. George W. Wightman; 3. Mrs. Marshall McLean; 4. Miss Florence Sutton; 5. Mrs. Barger-Wallach; 6. Miss Marie Wagner; 7. Miss Anita Myers; 8. Miss Sara Livingston; 9. Miss Clare Cassel; 10. Miss Eleonora Sears.

1916—1. Miss Molla Bjurstedt; 2. Mrs. Edward Raymond; 3. Miss Evelyn Sears; 4. Miss Anita Myers; 5. Miss Sara Livingston; 6. Miss Marie Wagner; 7. Mrs. Homer S. Green; 8. Miss Martha Guthrie; 9. Miss Eleonora Sears; 10. Mrs. Barger-Wallach.

1918—1. Miss Molla Bjurstedt; 2. Mrs. George W. Wightman; 3. M. S. Homer S. Green; 4. Miss Eleanor Goss; 5. Miss Marie Wagner; 6. Miss Carrie B. Neely; 7. Miss Corinne Gould; 8. Miss Helene Pollak; 9. Miss Edith B. Handy; 10. Miss Clare Cassel.

**Players Not Ranked in 1917**

# International Matches for Davis Cup SINGLES.

| YEAR                               | WINNERS.                                      | OPPONENTS.                             |
|------------------------------------|---|--|
| 1900                               | M. D. Whitman, United States.....             | A. W. Gore, British Isles.             |
|                                    | D. F. Davis, United States.....               | E. D. Black, British Isles.            |
|                                    | D. F. Davis, United States.....               | A. W. Gore, British Isles.             |
|                                    | M. D. Whitman, United States.....             | E. D. Black, British Isles.            |
| 1901                               | No Matches.                                   |  |
| 1902                               | R. F. Doherty, British Isles .....            | W. A. Larned, United States.           |
|                                    | M. D. Whitman, United States.....             | Dr. J. Pim, British Isles.             |
|                                    | W. A. Larned, United States.....              | Dr. J. Pim, British Isles.             |
|                                    | M. D. Whitman, United States.....             | R. F. Doherty, British Isles.          |
| 1903                               | H. L. Doherty, British Isles .....            | R. D. Wrenn, United States.            |
|                                    | W. A. Larned, United States.....              | R. F. Doherty, British Isles (by def.) |
|                                    | H. L. Doherty, British Isles .....            | W. A. Larned, United States.           |
|                                    | R. F. Doherty, British Isles .....            | R. D. Wrenn, United States.            |
| 1904                               | Belgium vs. France (Final) —                  |  |
|                                    | M. Decugis, France.....                       | P. de Borman, Belgium                  |
|                                    | P. de Borman, Belgium.....                    | P. Aymé, France.                       |
|                                    | W. Lemaire, Belgium.....                      | M. Decugis, France.                    |
|                                    | W. Lemaire, Belgium.....                      | P. Aymé, France.                       |
|                                    | British Isles vs. Belgium (Challenge)         |  |
|                                    | H. L. Doherty, British Isles.....             | P. de Borman, Belgium.                 |
|                                    | H. L. Doherty, British Isles.....             | W. Lemaire, Belgium.                   |
|                                    | F. L. Riseley, British Isles.....             | P. de Borman, Belgium.                 |
|                                    | F. L. Riseley, British Isles.....             | W. Lemaire, Belgium.                   |
| 1905                               | United States vs. France (Preliminary) —      |  |
|                                    | H. Ward, United States.....                   | M. Germot, France.                     |
|                                    | W. J. Clothier, United States.....            | M. Decugis, France.                    |
|                                    | H. Ward, United States.....                   | M. Decugis, France.                    |
|                                    | W. J. Clothier, United States.....            | M. Germot, France.                     |
|                                    | Australasia vs. Austria (Preliminary) —       |  |
|                                    | N. E. Brookes, Australasia.....               | R. Kinzl, Austria.                     |
|                                    | N. E. Brookes, Australasia.....               | C. von Wesseley, Austria.              |
|                                    | A. F. Wilding, Australasia.....               | R. Kinzl, Austria.                     |
|                                    | A. F. Wilding, Australasia.....               | C. von Wesseley, Austria.              |
|                                    | United States vs. Australasia (Final) —       |  |
|                                    | W. A. Larned, United States.....              | N. E. Brookes, Australasia.            |
|                                    | B. C. Wright, United States.....              | A. F. Wilding, Australasia.            |
|                                    | W. A. Larned, United States.....              | A. F. Wilding, Australasia.            |
|                                    | B. C. Wright, United States.....              | N. E. Brookes, Australasia.            |
|                                    | British Isles vs. United States (Challenge) — |  |
| H. L. Doherty, British Isles ..... | H. Ward, United States.                       |  |
| S. H. Smith, British Isles .....   | W. A. Larned, United States.                  |  |
| H. L. Doherty, British Isles.....  | W. A. Larned, United States.                  |  |
| S. H. Smith, British Isles.....    | W. J. Clothier, United States.                |  |
| 1906                               | United States vs. Australasia (Preliminary) — |  |
|                                    | H. Ward, United States.....                   | L. O. S. Poidevin, Australasia.        |
|                                    | A. F. Wilding, Australasia.....               | R. D. Little, United States.           |
|                                    | R. D. Little, United States.....              | L. O. S. Poidevin, Australasia.        |
|                                    | A. F. Wilding, Australasia.....               | H. Ward, United States.                |
|                                    | British Isles vs. United States (Challenge) — |  |
|                                    | S. H. Smith, British Isles.....               | R. D. Little, United States.           |
|                                    | H. L. Doherty, British Isles.....             | H. Ward, United States.                |
|                                    | S. H. Smith, British Isles.....               | H. Ward, United States.                |
|                                    | H. L. Doherty, British Isles.....             | R. D. Little, United States.           |



# International Matches for Davis Cup

## SINGLES—Continued.

| YEAR                             | WINNERS.                              | OPPONENTS.                       |
|----------------------------------|---------------------------------------|----------------------------------|
| 1907                             | United States vs. Australasia (Pre    | liminary)—                       |
|                                  | N. E. Brookes, Australasia.....       | B. C. Wright, United States.     |
|                                  | A. F. Wilding, Australasia.....       | K. H. Behr, United States.       |
|                                  | N. E. Brookes, Australasia.....       | K. H. Behr, United States.       |
|                                  | B. C. Wright, United States.....      | A. F. Wilding, Australasia.      |
|                                  | Australasia vs. British Isles (Chal   | lenge)—                          |
| N. E. Brookes, Australasia.....  | A. W. Gore, British Isles.            |                                  |
| A. F. Wilding, Australasia.....  | H. R. Barrett, British Isles.         |                                  |
| N. E. Brookes, Australasia.....  | H. R. Barrett, British Isles.         |                                  |
| A. W. Gore, British Isles.....   | A. F. Wilding, Australasia.           |                                  |
| 1908                             | United States vs. British Isles (Pre  | liminary)—                       |
|                                  | W. A. Larned, United States.....      | J. C. Parke, British Isles.      |
|                                  | M. J. G. Ritchie, British Isles.....  | B. C. Wright, United States.     |
|                                  | W. A. Larned, United States.....      | M. J. G. Ritchie, British Isles. |
|                                  | Australasia vs. United States (Chal   | lenge)—                          |
|                                  | N. E. Brookes, Australasia.....       | F. B. Alexander, United States.  |
| B. C. Wright, United States..... | A. F. Wilding, Australasia.           |                                  |
| B. C. Wright, United States..... | N. E. Brookes, Australasia.           |                                  |
| A. F. Wilding, Australasia.....  | F. B. Alexander, United States.       |                                  |
| 1909                             | United States vs. British Isles (Fi   | nal)—                            |
|                                  | W. A. Larned, United States.....      | C. P. Dixon, British Isles.      |
|                                  | W. J. Clothier, United States.....    | J. C. Parke, British Isles.      |
|                                  | W. A. Larned, United States.....      | J. C. Parke, British Isles.      |
|                                  | W. J. Clothier, United States.....    | C. P. Dixon, British Isles.      |
|                                  | Australasia vs. United States (Chal   | lenge)—                          |
| N. E. Brookes, Australasia.....  | M. E. McLoughlin, United States.      |                                  |
| A. F. Wilding, Australasia.....  | M. H. Long, United States.            |                                  |
| A. F. Wilding, Australasia.....  | M. E. McLoughlin, United States.      |                                  |
| N. E. Brookes, Australasia.....  | M. H. Long, United States.            |                                  |
| 1910                             | No Matches.                           |                                  |
| 1911                             | United States vs. British Isles (Fi   | nal)—                            |
|                                  | W. A. Larned, United States.....      | C. P. Dixon, British Isles.      |
|                                  | M. E. McLoughlin, United States...    | A. H. Lowe, British Isles.       |
|                                  | W. A. Larned, United States.....      | A. H. Lowe, British Isles.       |
|                                  | M. E. McLoughlin, United States...    | C. P. Dixon, British Isles.      |
|                                  | United States vs. Australasia (Chal   | lenge)—                          |
| N. E. Brookes, Australasia.....  | B. C. Wright, United States.          |                                  |
| R. W. Heath, Australasia.....    | W. A. Larned, United States.          |                                  |
| N. E. Brookes, Australasia.....  | M. E. McLoughlin, United States.      |                                  |
| R. W. Heath, Australasia.....    | B. C. Wright, United States (by def.) |                                  |
| 1912                             | British Isles vs. France (Prelimin    | ary)—                            |
|                                  | C. P. Dixon, British Isles.....       | M. Decugis, France.              |
|                                  | C. P. Dixon, British Isles.....       | A. H. Gobert, France.            |
|                                  | A. W. Gore, British Isles.....        | M. Decugis, France.              |
|                                  | A. H. Gobert, France.....             | A. W. Gore, British Isles.       |
|                                  | British Isles vs. Australasia (Chal   | lenge)                           |
| J. C. Parke, British Isles.....  | N. E. Brookes, Australasia.           |                                  |
| C. P. Dixon, British Isles.....  | R. W. Heath, Australasia.             |                                  |
| N. E. Brookes, Australasia.....  | C. P. Dixon, British Isles.           |                                  |
| J. C. Parke, British Isles.....  | R. W. Heath, Australasia.             |                                  |

# International Matches for Davis Cup

## SINGLES—Continued.

| YEAR   | WINNERS.                                    | OPPONENTS.                            |
|--|---|---------------------------------------|
| 1913   | United States vs. Australasia (Preliminary) | liminary)                             |
|  | M. E. McLoughlin, United States...          | Horace Rice, Australasia.             |
|  | M. E. McLoughlin, United States....         | S. N. Doust, Australasia.             |
|  | R. N. Williams, 2d, United States....       | S. N. Doust, Australasia.             |
|  | R. N. Williams, 2d, United States....       | Horace Rice, Australasia.             |
|  | Canada vs. South Africa (Preliminary)       | ary)—                                 |
|  | R. B. Powell, Canada.....                   | R. F. Le Sueur, So. Africa.           |
|  | R. B. Powell, Canada.....                   | V. R. Gauntlett, S. Africa (unplayed) |
|  | V. R. Gauntlett, So. Africa.....            | B. P. Schwengers, Canada.             |
|  | B. P. Schwengers, Canada.....               | R. F. Le Sueur, So. Africa.           |
|  | France vs. Germany (Preliminary)—           |                                       |
|  | O. Kreuzer, Germany.....                    | A. H. Gobert, France.                 |
|  | O. Kreuzer, Germany.....                    | M. Decugis, France (retired).         |
|  | M. Decugis, France.....                     | F. W. Rahe, Germany.                  |
|  | F. W. Rahe, Germany.....                    | A. H. Gobert, France.                 |
|  | United States vs. Germany (Semi-Final)—     | Final)—                               |
|  | M. E. McLoughlin, United States...          | O. Froitzheim, Germany.               |
|  | W. F. Johnson, United States.....           | O. Kreuzer, Germany.                  |
|  | R. N. Williams, 2d, United States....       | O. Kreuzer, Germany.                  |
|  | R. N. Williams, 2d, United States....       | O. Froitzheim, Germany.               |
|  | Canada vs. Belgium (Semi-Final)—            |                                       |
|  | R. B. Powell, Canada.....                   | P. de Borman, Belgium.*               |
|  | R. B. Powell, Canada.....                   | A. G. Watson, Belgium (unplayed)      |
| B. P. Schwengers, Canada.....                | A. G. Watson, Belgium.                      |                                       |
| B. P. Schwengers, Canada.....                | P. de Borman, Belgium.                      |                                       |
| United States vs. Canada (Final)—            |   |                                       |
| M. E. McLoughlin, United States....          | R. B. Powell, Canada.                       |                                       |
| R. N. Williams, 2d, United States....        | B. P. Schwengers, Canada.                   |                                       |
| M. E. McLoughlin, United States....          | B. P. Schwengers, Canada (unplayed)         |                                       |
| R. N. Williams, 2d, United States....        | R. B. Powell, Canada (unplayed)             |                                       |
| United States vs. British Isles (Challenge)— | lenge)—                                     |                                       |
| J. C. Parke, British Isles.....              | M. E. McLoughlin, United States.            |                                       |
| M. E. McLoughlin, United States....          | C. P. Dixon, British Isles.                 |                                       |
| R. N. Williams, 2d, United States....        | C. P. Dixon, British Isles.                 |                                       |
| J. C. Parke, British Isles.....              | R. N. Williams, 2d, United States.          |                                       |
| 1914   | British Isles vs. Belgium (Preliminary)     | ary)—                                 |
|  | T. M. Mavrogordato, British Isles...        | P. de Borman, Belgium.                |
|  | J. C. Parke, British Isles.....             | A. G. Watson, Belgium.                |
|  | J. C. Parke, British Isles.....             | P. de Borman, Belgium.                |
|  | T. M. Mavrogordato, British Isles...        | A. G. Watson, Belgium.                |
|  | Australasia vs. Canada (Preliminary)        | —                                     |
|  | N. E. Brookes, Australasia.....             | B. P. Schwengers, Canada.             |
|  | A. F. Wilding, Australasia.....             | R. B. Powell, Canada.                 |
|  | A. F. Wilding, Australasia.....             | B. P. Schwengers, Canada.             |
|  | N. E. Brookes, Australasia.....             | R. B. Powell, Canada.                 |
|  | British Isles vs. France (Semi-Final)—      | Final)—                               |
|  | T. M. Mavrogordato, British Isles...        | M. Germot, France.                    |
|  | J. C. Parke, British Isles.....             | M. Decugis, France.                   |
| T. M. Mavrogordato, British Isles...         | M. Decugis, France.                         |                                       |
| J. C. Parke, British Isles.....              | M. Germot, France.                          |                                       |

# International Matches for Davis Cup

## SINGLES—Continued.

| YEAR  | WINNERS.   | OPPONENT.   |
|-------|--|---|
| 1914  | Australasia vs. Germany (Semi-Final)—<br>A. F. Wilding, Australasia.....<br>N. E. Brookes, Australasia.....<br>A. F. Wilding, Australasia.....<br>N. E. Brookes, Australasia.....              | Final)—<br>O. Kreuzer, Germany.<br>O. Froitzheim, Germany.<br>O. Froitzheim, Germany.<br>O. Kreuzer, Germany.                         |
|       | Australasia vs. British Isles (Final)—<br>A. F. Wilding, Australasia.....<br>N. E. Brookes, Australasia.....   | A. H. Lowe, British Isles.<br>J. C. Parke, British Isles.   |
|       | Australasia vs. United States (Challenge)—<br>A. F. Wilding, Australasia.....<br>M. E. McLoughlin, United States....<br>N. E. Brookes, Australasia.....<br>M. E. McLoughlin, United States.... | R. N. Williams, 2d, United States.<br>N. E. Brookes, Australasia<br>R. N. Williams, 2d, United States.<br>A. F. Wilding, Australasia. |
| 1915- | 1919—No Matches.   |   |

# International Matches for Davis Cup

## DOUBLES.

| YEAR | WINNERS.  | OPPONENTS.   |
|------|---|--|
| 1900 | H. Ward..... }<br>D. F. Davis..... } United States  | E. D. Black..... }<br>H. R. Barrett..... } British Isles     |
| 1901 | No Matches.   |  |
| 1902 | R. F. Doherty..... }<br>H. L. Doherty..... } British Isles  | H. Ward..... }<br>D. F. Davis..... } United States           |
| 1903 | H. L. Doherty..... }<br>R. F. Doherty..... } British Isles  | R. D. Wrenn..... }<br>G. L. Wrenn..... } United States       |
| 1904 | Belgium vs. France (Final)—<br>M. Decugis..... }<br>P. Aymé..... } France                                     | W. Lemaire..... }<br>P. de Borman..... } Belgium             |
|      | British Isles vs. Belgium (Challenge)—<br>R. F. Doherty..... }<br>H. L. Doherty..... } British Isles          | —<br>W. Lemaire..... }<br>P. de Borman..... } Belgium        |
| 1905 | United States vs. France (Preliminary)—<br>H. Ward..... }<br>B. C. Wright..... } United States                | M. Germot..... }<br>M. Decugis..... } France                 |
|      | Australasia vs. Austria (Preliminary)—<br>N. E. Brookes..... }<br>A. W. Dunlop..... } Australasia             | R. Kinzl..... }<br>C. von Wesseley..... } Austria            |
|      | United States vs. Australasia (Final)—<br>H. Ward..... }<br>B. C. Wright..... } United States                 | N. E. Brookes..... }<br>A. W. Dunlop..... } Australasia      |
|      | British Isles vs. United States (Challenge)—<br>H. L. Doherty..... }<br>R. F. Doherty..... } British Isles    | H. Ward..... }<br>B. C. Wright..... } United States          |
| 1906 | United States vs. Australasia (Preliminary)—<br>H. Ward..... }<br>R. D. Little..... } United States           | A. F. Wilding..... }<br>L. O. S. Poidevin..... } Australasia |
|      | British Isles vs. United States (Challenge)—<br>H. L. Doherty..... }<br>R. F. Doherty..... } British Isles    | H. Ward..... }<br>R. D. Little..... } United States          |
| 1907 | United States vs. Australasia (Preliminary)—<br>B. C. Wright..... }<br>K. H. Behr..... } United States        | N. E. Brookes..... }<br>A. F. Wilding..... } Australasia     |
|      | Australasia vs. British Isles (Challenge)—<br>A. W. Gore..... }<br>H. R. Barrett..... } British Isles         | N. E. Brookes..... }<br>A. F. Wilding..... } Australasia     |
| 1908 | United States vs. British Isles (Preliminary)<br>H. H. Hackett..... }<br>F. B. Alexander..... } United States | M. J. G. Ritchie..... }<br>J. C. Parke..... } British Isles  |
|      | Australasia vs. United States (Challenge)—<br>N. E. Brookes..... }<br>A. F. Wilding..... } Australasia        | F. B. Alexander..... }<br>B. C. Wright..... } United States  |
| 1909 | United States vs. British Isles (Final)—<br>H. H. Hackett..... }<br>R. D. Little..... } United States         | J. C. Parke..... }<br>W. C. Crawley..... } British Isles     |
|      | Australasia vs. United States (Challenge)—<br>N. E. Brookes..... }<br>A. F. Wilding..... } Australasia        | M. E. McLoughlin..... }<br>M. H. Long..... } United States   |
| 1910 | No Matches.   |  |

# International Matches for Davis Cup

## DOUBLES—Continued.

| YEAR | WINNERS.   | OPPONENTS.   |  |
|------|--|--|--|
| 1911 | United States vs. British Isles (Final)—<br>A. E. Beamish..... }<br>C. P. Dixon..... } British Isles       | T. C. Bundy..... }<br>R. D. Little..... } United States      |  |
|      | Australasia vs. United States (Challenge)—<br>N. E. Brookes..... }<br>A. W. Dunlop..... } Australasia      | B. C. Wright..... }<br>M. E. McLoughlin... } United States   |  |
| 1912 | British Isles vs. France (Preliminary)—<br>C. P. Dixon..... }<br>H. Roper Barrett... } British Isles       | A. H. Gobert..... }<br>W. H. Laurentz..... } France          |  |
|      | Australasia vs. British Isles (Challenge)—<br>N. E. Brookes..... }<br>A. W. Dunlop..... } Australasia      | J. C. Parke..... }<br>A. E. Beamish..... } British Isles     |  |
| 1913 | United States vs. Australasia (Preliminary)—<br>A. B. Jones..... }<br>S. N. Doust..... } Australasia       | H. H. Hackett..... }<br>M. E. McLoughlin.. } United States   |  |
|      | Canada vs. South Africa (Preliminary)—<br>R. B. Powell..... }<br>B. P. Schwengers..... } Canada            | V. R. Gauntlett..... }<br>R. F. Le Sueur..... } South Africa |  |
|      | France vs. Germany (Preliminary)—<br>H. Kleinschroth..... }<br>F. W. Rahe..... } Germany                   | M. Decugis..... }<br>M. Germot..... } France                 |  |
|      | United States vs. Germany (Semi-Final)—<br>H. H. Hackett..... }<br>M. E. McLoughlin.. } United States      | H. Kleinschroth..... }<br>F. W. Rahe..... } Germany          |  |
|      | Canada vs. Belgium (Semi-Final)—<br>R. B. Powell..... }<br>B. P. Schwengers..... } Canada                  | A. G. Watson..... }<br>W. H. Duvivier..... } Belgium         |  |
|      | United States vs. Canada (Final)—<br>H. H. Hackett..... }<br>M. E. McLoughlin.. } United States            | R. B. Powell..... }<br>B. P. Schwengers..... } Canada        |  |
|      | United States vs. British Isles (Challenge)—<br>H. H. Hackett..... }<br>M. E. McLoughlin.. } United States | C. P. Dixon..... }<br>H. Roper Barrett... } British Isles    |  |
|      | British Isles vs. Belgium (Preliminary)—<br>H. Roper Barrett... }<br>T. M. Mavrogordato. } British Isles   | W. H. Duvivier..... }<br>A. G. Watson..... } Belgium         |  |
|      | Australasia vs. Canada (Preliminary)—<br>N. E. Brookes..... }<br>A. F. Wilding..... } Australasia          | B. P. Schwengers..... }<br>R. B. Powell..... } Canada        |  |
|      | British Isles vs. France (Semi-Final)—<br>M. Decugis..... }<br>M. Germot..... } France                     | H. Roper Barrett... }<br>T. M. Mavrogordato. } British Isles |  |
| 1914 | Australasia vs. Germany (Semi-Final)—<br>N. E. Brookes..... }<br>A. F. Wilding..... } Australasia          | O. Froitzheim..... }<br>O. Kreuzer..... } Germany            |  |
|      | Australasia vs. British Isles (Final)—<br>N. E. Brookes..... }<br>A. F. Wilding..... } Australasia         | J. C. Parke..... }<br>T. M. Mavrogordato. } British Isles    |  |
|      | Australasia vs. United States (Challenge)—<br>N. E. Brookes..... }<br>A. F. Wilding..... } Australasia     | M. E. McLoughlin.. }<br>T. C. Bundy..... } United States     |  |
|      | 1915—  | 1919—No Matches.   |  |

## National Champions Since 1881

| Year  | Champion                | Winner All-Comers'      | Doubles Champions                       |
|-------|-------------------------|-------------------------|---|
| 1881  | R. D. Sears.....        | R. D. Sears.....        | C. M. Clark and F. W. Taylor            |
| 1882  | R. D. Sears.....        | R. D. Sears.....        | R. D. Sears and J. Dwight               |
| 1883  | R. D. Sears.....        | R. D. Sears.....        | R. D. Sears and J. Dwight               |
| 1884  | R. D. Sears.....        | H. A. Taylor.....       | R. D. Sears and J. Dwight               |
| 1885  | R. D. Sears.....        | G. M. Brinley.....      | R. D. Sears and J. S. Clark             |
| 1886  | R. D. Sears.....        | R. L. Beeckman.....     | R. D. Sears and J. Dwight               |
| 1887  | R. D. Sears.....        | H. W. Slocum, Jr.....   | R. D. Sears and J. Dwight               |
| 1888  | H. W. Slocum, Jr.....   | H. W. Slocum, Jr.....   | O. S. Campbell and V. G. Hall           |
| 1889  | H. W. Slocum, Jr.....   | Q. A. Shaw, Jr.....     | V. G. Hall and H. A. Taylor             |
| 1890  | O. S. Campbell.....     | O. S. Campbell.....     | H. G. Hall and C. Hobart                |
| 1891  | O. S. Campbell.....     | C. Hobart.....          | O. S. Campbell and R. P. Huntington, Jr |
| 1892  | R. D. Wrenn.....        | F. H. Hovey.....        | O. S. Campbell and R. P. Huntington, Jr |
| 1893  | R. D. Wrenn.....        | R. D. Wrenn.....        | C. Hobart and F. H. Hovey               |
| 1894  | R. D. Wrenn.....        | M. F. Goodbody.....     | C. Hobart and F. H. Hovey               |
| 1895  | F. H. Hovey.....        | F. H. Hovey.....        | C. Hobart and F. H. Hovey               |
| 1896  | R. D. Wrenn.....        | R. D. Wrenn.....        | M. G. Chace and R. D. Wrenn             |
| 1897  | R. D. Wrenn.....        | W. V. Eaves.....        | C. B. Neel and S. R. Neel               |
| 1898  | M. D. Whitman.....      | M. D. Whitman.....      | L. E. Ware and G. P. Sheldon, Jr.       |
| 1899  | M. D. Whitman.....      | J. P. Paret.....        | L. E. Ware and G. P. Sheldon, Jr.       |
| 1900  | M. D. Whitman.....      | W. A. Larned.....       | D. F. Davis and H. Ward                 |
| 1901  | W. A. Larned.....       | W. A. Larned.....       | D. F. Davis and H. Ward                 |
| 1902  | W. A. Larned.....       | R. F. Doherty.....      | R. F. Doherty and H. L. Doherty         |
| 1903  | H. L. Doherty.....      | H. L. Doherty.....      | R. F. Doherty and H. L. Doherty         |
| 1904  | H. Ward.....            | H. Ward.....            | H. Ward and B. C. Wright                |
| 1905  | B. C. Wright.....       | B. C. Wright.....       | H. Ward and B. C. Wright                |
| 1906  | W. J. Clothier.....     | W. J. Clothier.....     | H. Ward and B. C. Wright                |
| 1907  | W. A. Larned.....       | W. A. Larned.....       | F. B. Alexander and H. H. Hackett       |
| 1908  | W. A. Larned.....       | B. C. Wright.....       | F. B. Alexander and H. H. Hackett       |
| 1909  | W. A. Larned.....       | W. J. Clothier.....     | F. B. Alexander and H. H. Hackett       |
| 1910  | W. A. Larned.....       | T. C. Bundy.....        | F. B. Alexander and H. H. Hackett       |
| 1911  | W. A. Larned.....       | M. E. McLoughlin.....   | R. D. Little and G. F. Touchard         |
| 1912  | M. E. McLoughlin.....   | M. E. McLoughlin.....   | M. E. McLoughlin and T. C. Bundy        |
| 1913  | M. E. McLoughlin.....   | M. E. McLoughlin.....   | M. E. McLoughlin and T. C. Bundy        |
| 1914  | R. N. Williams, 2d..... | R. N. Williams, 2d..... | M. E. McLoughlin and T. C. Bundy        |
| 1915  | W. M. Johnston.....     | W. M. Johnston.....     | W. M. Johnston and C. J. Griffin        |
| 1916  | R. N. Williams, 2d..... | R. N. Williams, 2d..... | F. B. Alexander and C. J. Griffin       |
| 1917* | R. L. Murray.....       | R. L. Murray.....       | F. B. Alexander and H. A. Throckmorton  |
| 1918  | R. L. Murray.....       | R. L. Murray.....       | Vincent Richards and W. T. Tilden, Jr.  |

\* Patriotic tournament without championships.

**Semi-Finalists in National Tournaments**

| Year | Winner All-Comers' | Runner-up          | Defeated by Winner in Semi-finals | Defeated by Runner-up in Semi-finals |
|------|--------------------|--------------------|-----------------------------------|--------------------------------------|
| 1881 | R. D. Sears        | W. E. Glyn         | E. Gray                           | R. G. Shaw                           |
| 1882 | R. D. Sears        | C. M. Clark        | J. S. Rankine                     | E. Gray                              |
| 1883 | R. D. Sears        | J. Dwight          | F. Keene                          | R. F. Conover                        |
| 1884 | H. A. Taylor       | W. V. S. Thorne    | W. P. Knapp                       | C. M. Clark                          |
| 1885 | G. M. Brimley      | W. F. Knapp        | W. V. R. Berry                    | J. S. Clark                          |
| 1886 | H. L. Beeckman     | H. A. Taylor       | C. A. Chase                       | J. S. Clark                          |
| 1887 | R. W. Slocum, Jr.  | H. A. Taylor       | J. S. Clark                       | W. L. Thacher                        |
| 1888 | H. W. Slocum, Jr.  | H. A. Taylor       | O. S. Campbell                    | P. S. Sears                          |
| 1889 | O. A. Shaw, Jr.    | O. S. Campbell     | W. P. Knapp                       | E. G. Meers                          |
| 1890 | O. S. Campbell     | W. P. Knapp        | R. P. Huntington, Jr.             | C. Hobart                            |
| 1891 | C. Hobart          | F. H. Hovey        | V. G. Tall                        | M. D. Smith                          |
| 1892 | F. H. Hovey        | W. A. Larned       | R. D. Wrenn                       | E. L. Hall                           |
| 1893 | R. D. Wrenn        | F. H. Hovey        | S. T. Chase                       | C. Hobart                            |
| 1894 | M. F. Goodbody     | W. A. Larned       | J. B. Read                        | M. G. Chace                          |
| 1895 | F. H. Hovey        | W. A. Larned       | C. B. Neel                        | J. Howland                           |
| 1896 | R. D. Wrenn        | W. A. Larned       | C. B. Neel                        | E. P. Fischer                        |
| 1897 | W. V. Eaves        | H. A. Nisbet       | L. E. Ware                        | W. A. Larned                         |
| 1898 | M. D. Whitman      | D. F. Davis        | L. E. Ware                        | W. S. Bond                           |
| 1899 | J. P. Paret        | D. F. Davis        | L. E. Ware                        | K. Collins                           |
| 1900 | W. A. Larned       | G. L. Wrenn, Jr.   | B. C. Wright                      | A. W. Gore                           |
| 1901 | W. A. Larned       | B. C. Wright       | L. E. Ware                        | R. D. Little                         |
| 1902 | R. F. Doherty      | M. D. Whitman      | H. L. Doherty                     | R. P. Huntington, Jr.                |
| 1903 | H. L. Doherty      | W. J. Clothier     | R. H. Carleton                    | E. P. Larned                         |
| 1904 | H. Ward            | W. J. Clothier     | E. W. Leonard                     | W. A. Larned                         |
| 1905 | B. C. Wright       | C. Hobart          | W. A. Larned                      | K. Collins                           |
| 1906 | W. J. Clothier     | K. H. Rahr         | J. D. E. Jones                    | R. D. Little                         |
| 1907 | W. A. Larned       | R. Leloy           | C. Hobart                         | H. Mollenhauer                       |
| 1908 | B. C. Wright       | F. B. Alexander    | N. Emerson                        | W. J. Clothier                       |
| 1909 | W. J. Clothier     | M. E. McLoughlin   | T. C. Bundy                       | G. F. Touchard                       |
| 1910 | T. C. Bundy        | Beals C. Wright    | F. C. Colston                     | E. H. Whitney                        |
| 1911 | M. E. McLoughlin   | R. C. Wright       | G. F. Touchard                    | T. C. Bundy                          |
| 1912 | M. E. McLoughlin   | W. F. Johnson      | W. J. Clothier                    | K. H. Behr                           |
| 1913 | M. E. McLoughlin   | R. N. Williams, 2d | W. F. Johnson                     | N. W. Niles                          |
| 1914 | R. N. Williams, 2d | M. E. McLoughlin   | E. F. Fottrell                    | W. J. Clothier                       |
| 1915 | W. M. Johnston     | M. E. McLoughlin   | R. N. Williams, 2d                | T. R. Pell                           |
| 1916 | R. N. Williams, 2d | W. M. Johnston     | C. J. Griffin                     | R. L. Murray                         |
| 1917 | R. L. Murray       | N. W. Niles        | J. R. Strachan                    | R. N. Williams, 2d                   |
| 1918 | R. L. Murray       | W. T. Tilden, Jr   | Lieut. S. H. Voshell              | Ichiva Kuma a                        |

Patriotic tournament without championships.

## Finalists in Doubles in National Tournaments

| Year | Winners All-Corners'                         | Runners-up                                    |
|------|--|---|
| 1881 | C. M. Clark and F. W. Taylor.....            | A. Van Rensselaer and A. E. Newbold           |
| 1882 | R. D. Sears and J. Dwight.....               | W. Nightingale and G. M. Smith                |
| 1883 | R. D. Sears and J. Dwight.....               | A. Van Rensselaer and A. E. Newbold           |
| 1884 | R. D. Sears and J. Dwight.....               | A. Van Rensselaer and W. V. Berry             |
| 1885 | R. D. Sears and J. S. Clark.....             | H. W. Slocum, Jr., and W. P. Knapp            |
| 1886 | R. D. Sears and J. Dwight.....               | H. A. Taylor and G. M. Brimley                |
| 1887 | R. D. Sears and J. Dwight.....               | H. A. Taylor and H. W. Slocum, Jr.            |
| 1888 | O. S. Campbell and V. G. Hall.....           | C. Hobart and E. P. MacMuller                 |
| 1889 | H. W. Slocum, Jr., and H. A. Taylor.....     | V. G. Hall and O. S. Campbell                 |
| 1890 | V. G. Hall and C. Hobart.....                | C. W. Carver and J. A. Ryerson..... West      |
| 1891 | O. S. Campbell and R. P. Huntington, Jr..... | S. T. Chase and J. A. Ryerson..... West       |
| 1892 | V. G. Hall and E. L. Hall.....               | C. W. Carver and J. A. Ryerson..... West      |
| 1893 | C. Hobart and F. H. Hovey.....               | J. S. Clark and S. T. Chase..... West         |
| 1894 | C. B. Neel and S. R. Neel.....               | J. Howland and A. E. Foote..... East          |
| 1895 | M. G. Chace and R. D. Wrenn.....             | C. B. Neel and S. R. Neel..... West           |
| 1896 | C. B. Neel and S. R. Neel.....               | F. H. Hovey and C. Hobart..... East           |
| 1897 | L. Ware and G. P. Sheldon, Jr.....           | H. A. Nisbet and H. S. Mahony..... East       |
| 1898 | H. Ward and D. F. Davis.....                 | G. L. Wrenn, Jr., and M. D. Whitman..... East |
| 1899 | H. Ward and D. F. Davis.....                 | H. H. Hackett and J. A. Allen..... West       |
| 1900 | R. D. Little and F. B. Alexander.....        | H. H. Hackett and J. A. Allen..... East       |
| 1901 | B. C. Wright and L. E. Ware.....             | R. D. Little and F. B. Alexander..... West    |
| 1902 | R. F. Doherty and H. L. Doherty.....         | K. Collins and L. H. Waldner..... West        |
| 1903 | K. Collins and L. H. Waldner.....            | H. Ward and L. E. Ware..... East              |
| 1904 | H. Ward and B. C. Wright.....                | R. D. Little and K. Collins..... West         |
| 1905 | F. B. Alexander and H. H. Hackett.....       | K. Collins and L. H. Waldner..... West        |
| 1906 | F. B. Alexander and H. H. Hackett.....       | L. H. Waldner and N. Emerson..... West        |

Beginning with 1907, the East, West and Southern Sectional Championship Meeting was inaugurated, since which time the following Sections have been added: 1909, Pacific Coast; 1915, Northwestern; 1916, Middle Atlantic, Missouri Valley, Southwestern; 1917, Pacific Northwest.



## FINALISTS IN DOUBLES IN NATIONAL TOURNAMENTS—Continued.

Abbreviations—E, East; W, West; S, Southern; PC, Pacific Coast; NW, Northwestern; MA, Middle Atlantic; MV, Missouri Valley; SW, Southwestern; PN, Pacific Northwest.

| Year. | Winners of Final Round and Summary of Play,   |
|-------|---|
| 1907  | F. B. Alexander and H. H. Hackett (W).<br>Alexander and Hackett d. W. J. Clothier and W. A. Larned (E);<br>Alexander and Hackett d. B. M. Grant and N. Thornton (S).  |
| 1908  | B. C. Wright and R. D. Little (E).<br>Wright and Little d. H. G. Whitehead and J. H. Winston (S);<br>Wright and Little d. L. H. Waidner and N. Emerson (W).   |
| 1909  | M. E. McLoughlin and G. Janes (PC).<br>T. R. Pell and W. C. Grant (S) d. T. Emerson and R. A. Holden,<br>Jr. (W); McLoughlin and Janes d. N. W. Niles and A. S.<br>Dabney, Jr. (E); McLoughlin and Janes d. Pell and Grant.   |
| 1910  | T. C. Bundy and T. W. Hendrick (PC).<br>P. Gardner and L. H. Waidner (W) d. C. B. Doyle and H. E. Doyle<br>(S); Bundy and Hendrick d. E. H. Whitney and R. Bishop (E);<br>Bundy and Hendrick d. Gardner and Waidner.  |
| 1911  | R. D. Little and G. F. Touchard (E).<br>Little and Touchard d. M. E. McLoughlin and T. C. Bundy (PC);<br>C. B. Doyle and H. E. Doyle (S) d. C. M. Bull, Jr., and H. C.<br>Martin (W); Little and Touchard d. Doyle and Doyle.   |
| 1912  | M. E. McLoughlin and T. C. Bundy (PC).<br>W. T. Hayes and J. H. Winston (W) d. W. J. Clothier and G. P.<br>Gardner, Jr. (E); McLoughlin and Bundy d. C. Y. Smith and Nat.<br>Thornton (S); McLoughlin and Bundy d. Hayes and Winston.   |
| 1913  | J. R. Strachan and C. J. Griffin (PC).<br>Strachan and Griffin d. J. B. Adoue and R. F. Shelton (S); W. M.<br>Washburn and G. F. Touchard (E) d. H. T. Byford and R. H.<br>Burdick (W); Strachan and Griffin d. Washburn and Touchard.  |
| 1914  | G. M. Church and D. Mathey (W).<br>Church and Mathey d. I. C. Wright and J. B. Adoue, Jr. (S);<br>K. H. Behr and T. R. Pell (E) d. W. M. Johnston and C. J. Griffin<br>(PC); Church and Mathey d. Behr and Pell.  |
| 1915  | W. M. Johnston and C. J. Griffin (PC).<br>Johnston and Griffin d. R. N. Williams, 2d, and W. M. Washburn<br>(E); W. T. Hayes and R. H. Burdick (W) d. B. M. Grant and<br>N. Thornton (S); Johnston and Griffin d. G. M. Church and D.<br>Mathey (NW); Johnston and Griffin d. Hayes and Burdick.  |
| 1916  | M. E. McLoughlin and W. Dawson (PC).<br>N. Emerson and L. Hardy (S) d. S. Stellwagen and T. L. Jayne<br>(NW); McLoughlin and Dawson d. J. Cannon and A. L. Lindauer<br>(MV); W. E. Davis and G. M. Church (E) d. C. B. Doyle and<br>H. E. Breck (MA); W. T. Hayes and R. H. Burdick (W) d. F. H.<br>Wright and B. Hogue (SW); McLoughlin and Dawson d. Emerson<br>and Hardy; Davis and Church d. Hayes and Burdick; McLoughlin<br>and Dawson d. Davis and Church. |
| 1917  | F. B. Alexander and H. A. Throckmorton d. H. C. Johnson and I. C.<br>Wright in the final round of patriotic doubles, which was played in<br>one tournament, the winners playing through, but no champion-<br>ship title was awarded.  |
| 1918  | Vincent Richards and W. T. Tilden, Jr., d. Fred B. Alexander and<br>Beals C. Wright in the final round, all teams playing through.  |

# National Women Champions

| Year  | Singles                 | Doubles                                | Mixed Doubles                            |
|-------|-------------------------|--|--|
| 1887  | Miss Ellen F. Hansell   |  |  |
| 1888  | Miss B. L. Townsend     |  |  |
| 1889  | Miss B. L. Townsend     |  |  |
| 1890  | Miss E. C. Roosevelt    |  |  |
| 1891  | Miss Mabel E. Cahill    | Misses E. C. and G. W. Roosevelt       |  |
| 1892  | Miss Mabel E. Cahill    | Miss M. E. Cahill and Mrs. F. Morgan   | Miss M. E. Cahill and Clarence Hobart    |
| 1893  | Miss Aline M. Terry     | Misses M. E. Cahill and A. M. McKinley | Miss E. C. Roosevelt and Clarence Hobart |
| 1894  | Miss Helen R. Helwig    | Misses H. R. Helwig and J. P. Atkinson | Miss J. P. Atkinson and E. P. Fischer    |
| 1895  | Miss J. P. Atkinson     | Misses J. P. Atkinson and H. R. Helwig | Miss J. P. Atkinson and E. P. Fischer    |
| 1896  | Miss Elizabeth H. Moore | Misses E. H. Moore and J. P. Atkinson  | Miss J. P. Atkinson and E. P. Fischer    |
| 1897  | Miss J. P. Atkinson     | Misses J. P. Atkinson and K. Atkinson  | Miss Laura Henson and D. L. Magruder     |
| 1898  | Miss J. P. Atkinson     | Misses J. P. Atkinson and K. Atkinson  | Miss Carrie Neely and E. P. Fischer      |
| 1899  | Miss Marion Jones       | Misses M. McAteer and J. Craven        | Miss Edith Rastall and A. L. Hoskins     |
| 1900  | Miss Myrtle McAteer     | Misses J. Parker and H. Champlin       | Miss M. Hunnewell and Alfred Codman      |
| 1901  | Miss Elizabeth H. Moore | Misses M. McAteer and J. P. Atkinson   | Miss Marion Jones and E. D. Little       |
| 1902  | Miss Marion Jones       | Misses M. Jones and J. P. Atkinson     | Miss E. H. Moore and W. C. Grant         |
| 1903  | Miss Elizabeth H. Moore | Misses E. H. Moore and C. B. Neely     | Miss Chapman and Harry Allen             |
| 1904  | Miss May Sutton         | Misses M. Sutton and M. Hall           | Miss E. H. Moore and W. C. Grant         |
| 1905  | Miss Elizabeth H. Moore | Misses H. H. Homans and C. B. Neely    | Mr. and Mrs. Clarence Hobart             |
| 1906  | Miss Helen H. Homans    | Mrs. L. F. Coe and Mrs. D. F. Platt    | Miss Coffin and E. B. Dewhurst           |
| 1907  | Miss Evelyn Sears       | Misses Neely and Weimer                | Miss Sayres and W. F. Johnson            |
| 1908  | Mrs. Barger-Wallach     | Misses E. Sears and M. Curtis          | Miss E. Rotch and N. W. Niles            |
| 1909  | Miss Hazel Hotchkiss    | Misses H. Hotchkiss and E. Rotch       | Miss H. Hotchkiss and W. F. Johnson      |
| 1910  | Miss Hazel Hotchkiss    | Misses E. Rotch and H. Hotchkiss       | Miss Hotchkiss and J. R. Carpenter, Jr.  |
| 1911  | Miss Hazel Hotchkiss    | Misses E. Sears and H. Hotchkiss       | Miss Hotchkiss and W. F. Johnson         |
| 1912  | Miss Mary Browne        | Misses M. Browne and D. Green          | Miss M. Browne and R. N. Williams, 2d.   |
| 1913  | Miss Mary Browne        | Miss M. Browne and Mrs. R. H. Williams | Miss M. Browne and W. T. Tilden, Jr.     |
| 1914  | Miss Mary Browne        | Miss M. Browne and Mrs. R. H. Williams | Miss M. Browne and W. T. Tilden, Jr.     |
| 1915  | Miss Molla Bjurstedt    | Mrs. G. W. Wightman and Miss El. Sears | Mrs. G. W. Wightman and H. C. Johnson    |
| 1916  | Miss Molla Bjurstedt    | Miss M. Bjurstedt and Miss El. Sears   | Miss El. Sears and W. E. Davis           |
| 1917* | Miss Molla Bjurstedt    | Miss M. Bjurstedt and Miss El. Sears   | Miss M. Bjurstedt and I. C. Wright       |
| 1918  | Miss Molla Bjurstedt    | Miss E. Goss and Miss M. Zinderstein   | Mrs. G. W. Wightman and I. C. Wright     |

# Clay Court Champions

| Year  | Champion           | Winner All-Comers' | Doubles Champions                 |
|-------|--------------------|--------------------|-----------------------------------|
| 1910  | M. H. Long         | M. H. Long         | F. G. Anderson and W. T. Hayes    |
| 1911  | W. T. Hayes        | W. T. Hayes        | J. H. Winston and H. G. Whitehead |
| 1912  | R. N. Williams, 2d | R. N. Williams, 2d | H. H. Hackett and W. M. Hall      |
| 1913  | J. R. Strachan     | J. R. Strachan     | J. R. Strachan and C. J. Griffin  |
| 1914  | C. J. Griffin      | C. J. Griffin      | N. Browne and C. Wayne            |
| 1915  | R. N. Williams, 2d | R. N. Williams, 2d | G. M. Church and D. Mathey        |
| 1916  | W. E. Davis        | W. E. Davis        | G. M. Church and D. Mathey        |
| 1917* | Samuel Hardy       | Samuel Hardy       | C. S. Garland and Samuel Hardy    |
| 1918  | W. T. Tilden, Jr.  | W. T. Tilden, Jr.  | C. S. Garland and Samuel Hardy    |

## National Indoor Champions

| Y.R. | CHAMPION         | RUNNER-UP          | DOUBLES CHAMPIONS                       | RUNNERS-UP                               |
|------|------------------|--------------------|---|--|
| 1900 | J. A. Allen      | Calhoun Cragin     | Calhoun Cragin and J. P. Paret          | H. H. Hackett and J. A. Allen            |
| 1901 | Holcombe Ward    | Calhoun Cragin     | Calhoun Cragin and O. M. Bostwick       | Holcombe Ward and G. H. Miles            |
| 1902 | J. P. Paret      | W. C. Grant        | W. C. Grant and Robert LeRoy            | Calhoun Cragin and O. M. Bostwick        |
| 1903 | W. C. Grant      | Calhoun Cragin     | W. C. Grant and Robert LeRoy            | Calhoun Cragin and A. S. Cragin          |
| 1904 | W. C. Grant      | C. Carleton Kelley | W. C. Grant and Robert LeRoy            | Beals C. Wright and R. C. Kelley         |
| 1905 | E. B. Dewhurst   | W. C. Grant        | T. R. Pell and H. F. Allen              | Calhoun Cragin and C. C. Kelley          |
| 1906 | W. C. Grant      | E. P. Fischer      | F. B. Alexander and H. H. Hackett       | W. C. Grant and Irving C. Wright         |
| 1907 | T. R. Pell       | W. C. Grant        | F. B. Alexander and H. H. Hackett       | W. C. Grant and H. L. Westfall           |
| 1908 | W. C. Grant      | G. F. Touchard     | F. B. Alexander and H. H. Hackett       | W. B. Cragin, Jr., and Miles S. Charlock |
| 1909 | T. R. Pell       | G. C. Shafer       | W. C. Grant and T. R. Pell              | W. B. Cragin, Jr., and Miles S. Charlock |
| 1910 | G. F. Touchard   | R. A. Holden, Jr.  | G. F. Touchard and C. R. Gardner        | W. B. Cragin, Jr., and Miles S. Charlock |
| 1911 | T. R. Pell       | W. B. Cragin, Jr.  | F. B. Alexander and T. R. Pell          | Calhoun Cragin and W. C. Grant           |
| 1912 | W. C. Grant      | W. B. Cragin, Jr.  | F. B. Alexander and T. R. Pell          | W. C. Grant and L. M. Burt               |
| 1913 | G. F. Touchard   | G. C. Shafer       | W. C. Grant and G. C. Shafer            | G. F. Touchard and W. B. Cragin, Jr.     |
| 1914 | G. F. Touchard   | Dr. W. Rosenbaum   | W. C. Grant and G. C. Shafer            | G. F. Touchard and W. B. Cragin, Jr.     |
| 1915 | G. F. Touchard   | A. M. Lovibond     | G. F. Touchard and W. M. Washburn       | K. H. Behr and T. R. Pell                |
| 1916 | R. L. Murray     | A. H. Man, Jr.     | A. M. Lovibond and Dr. W. Rosenbaum     | King Smith and A. S. Cragin              |
| 1917 | S. H. Voshell    | C. B. Herd         | F. B. Alexander and Dr. W. Rosenbaum    | A. H. Man, Jr., and C. B. Herd           |
| 1918 | S. H. Voshell    | F. B. Alexander    | G. C. Shafer and Lieut. K. Smith        | C. Donaldson and W. T. Tilden, Jr.       |
| 1919 | Vincent Richards | W. T. Tilden, Jr.  | W. T. Tilden, Jr., and Vincent Richards | F. B. Alexander and Dr. W. Rosenbaum     |

## National Indoor Women Champions

| Y.R. | CHAMPION         | RUNNER-UP        | DOUBLES CHAMPIONS                   | RUNNERS-UP                            |
|------|------------------|------------------|-------------------------------------|---------------------------------------|
| 1907 | Miss E. H. Moore | Miss M. Wagner   | Mrs. W. H. Pouch & Miss E. H. Moore | Mrs. A. H. McCarthy & Miss M. Johnson |
| 1908 | Miss M. Wagner   | Mrs. F. Schmitz  | Miss E. H. Moore & Miss E. Marcus   | Miss M. Wagner & Miss L. Hammond      |
| 1909 | Mrs. F. Schmitz  | Miss E. Marcus   | Miss M. Wagner & Miss C. Kutroff    | Miss E. H. Moore & Miss E. Marcus     |
| 1910 | Miss M. Wagner   | Mrs. F. Schmitz  | Miss E. Bunce & Miss B. Fleming     | Mrs. F. Schmitz & Miss E. Marcus      |
| 1912 | No tournament    |                  |                                     |                                       |
| 1913 | Miss M. Wagner   | Mrs. C. N. Beard | Miss M. Wagner & Miss C. Kutroff    | Miss M. Fish & Miss A. Fish           |
| 1914 | Miss M. Wagner   | Mrs. C. N. Beard | Mrs. S. F. Weaver & Miss C. Cassel  | Mrs. M. McLean & Mrs. F. Schmitz      |
| 1915 | Miss M. Bjustedt | Miss M. Wagner   | Mrs. M. McLean & Mrs. S. F. Weaver  | Miss M. Bjustedt & Miss F. Ballin     |
| 1916 | Miss M. Bjustedt | Mrs. F. Schmitz  | Miss M. Wagner & Miss M. Bjustedt   | Mrs. F. Schmitz & Mrs. S. F. Weaver   |
| 1917 | Miss M. Wagner   | Miss E. Goss     | Miss M. Wagner & Miss M. Taylor     | Miss E. Rayser & Miss E. Howe         |
| 1918 | Miss M. Bjustedt | Miss E. Goss     | Mrs. S. F. Weaver and Miss E. Goss  | Mrs. H. S. Green and Miss C. Winn     |
| 1919 | Mrs. Wightman    | Miss Zinderstein | Mrs. Wightman and Miss Zinderstein  | Mrs. A. Humphries and Miss B. Holden  |

# Intercollegiate Champions Since 1883

| Year.     | Winner of Singles.    | College.    | Winners of Doubles.                      | College.     |
|-----------|-----------------------|-------------|--|--------------|
| 1883      | J. S. Clark (spring)  | Harvard     | J. S. Clark and H. A. Taylor (spring)    | Harvard      |
| 1884      | H. A. Taylor (fall)   | Harvard     | H. A. Taylor and P. E. Freshney (fall)   | Harvard      |
| 1885      | W. P. Knapp           | Yale        | W. P. Knapp and W. B. S. Thorne          | Yale         |
| 1886      | G. M. Brimley         | Yale        | W. P. Knapp and A. L. Shipman            | Yale         |
| 1887      | P. S. Sears           | Trinity     | W. F. Knapp and W. L. Thatcher           | Yale         |
| 1888      | P. S. Sears           | Harvard     | P. S. Sears and O. A. Shaw, Jr.          | Columbia     |
| 1889      | R. F. Huntington, Jr. | Harvard     | O. S. Campbell and A. E. Wright          | Columbia     |
| 1890      | F. H. Hovey           | Yale        | Q. A. Shaw, Jr. and S. T. Chase          | Harvard      |
| 1891      | F. H. Hovey           | Harvard     | F. H. Hovey and R. D. Wrenn              | Harvard      |
| 1892      | W. A. Larned          | Cornell     | R. D. Wrenn and F. B. Winslow            | Harvard      |
| 1893      | M. G. Chace           | Brown       | M. G. Chace and C. R. Budlong            | Harvard      |
| 1894      | M. G. Chace           | Yale        | M. G. Chace and A. E. Foote              | Brown        |
| 1895      | M. G. Chace           | Yale        | M. G. Chace and A. E. Foote              | Yale         |
| 1896      | M. D. Whitman         | Yale        | L. E. Ware and W. M. Scudder             | Yale         |
| 1897      | S. G. Thomson         | Princeton   | L. E. Ware and M. D. Whitman             | Harvard      |
| 1898      | L. E. Ware            | Harvard     | L. E. Ware and M. D. Whitman             | Harvard      |
| 1899      | D. F. Davis           | Harvard     | Holcombe Ward and D. F. Davis            | Harvard      |
| 1900      | R. D. Little          | Princeton   | F. B. Alexander and R. D. Little         | Harvard      |
| 1901      | F. B. Alexander       | Princeton   | H. A. Plummer and S. L. Russell          | Princeton    |
| 1902      | W. J. Clodier         | Harvard     | W. J. Clodier and F. W. Leonard          | Yale         |
| 1903      | F. B. Dewhurst        | U. of Penn. | B. Colston and E. Clapp                  | Harvard      |
| 1904      | R. LeRoy              | Columbia    | Behr and Bodman                          | Yale         |
| 1905      | F. B. Dewhurst        | U. of Penn. | Dewhurst and Register                    | Yale         |
| 1906      | R. LeRoy              | U. of Penn. | Wells and Spaulding                      | Pennsylvania |
| 1907      | G. P. Gardner         | Columbia    | N. W. Niles and A. S. Dabney             | Yale         |
| 1908      | N. W. Niles           | Harvard     | H. M. Tilden and A. Thayer               | Harvard      |
| 1909      | W. F. Johnson         | Harvard     | W. F. Johnson and A. Thayer              | Pennsylvania |
| 1910      | R. A. Holden, Jr.     | U. of Penn. | D. Mathey and B. N. Dell                 | Princeton    |
| 1911      | E. H. Whitney         | Yale        | D. Mathey and Butler                     | Princeton    |
| 1912      | G. M. Church          | Harvard     | G. M. Church and W. H. Mace              | Princeton    |
| 1913      | R. N. Williams, 2nd   | Harvard     | R. N. Williams, 2nd, and J. J. Armstrong | Princeton    |
| 1914      | G. M. Church          | Harvard     | W. M. Washburn and J. J. Armstrong       | Harvard      |
| 1915      | R. N. Williams, 2nd   | Harvard     | R. N. Williams, 2nd, and Richard Harte   | Harvard      |
| 1916      | G. C. Caner           | Harvard     | G. C. Caner and Richard Harte            | Harvard      |
| 1917-1918 | No tournaments.       |             |  |              |

## Sectional Champions

## NEW ENGLAND.

| Yr.  | CHAMPION.             | TOUR'T WINNER         | DOUBLES CHAMPION S.                   |
|------|-----------------------|-----------------------|---------------------------------------|
| 1886 | H. W. Slocum.....     | H. W. Slocum.....     | H. W. Slocum and W. L. Thacher        |
| 1887 | H. W. Slocum.....     | H. W. Slocum.....     | F. G. Beach and W. L. Thacher         |
| 1888 | H. W. Slocum.....     | E. P. MacMullen....   | O. S. Campbell and V. G. Hall         |
| 1889 | H. W. Slocum.....     | R. P. Huntington, Jr. | F. G. Beach, R. P. Huntington, Jr.    |
| 1890 | R. P. Huntington, Jr. | R. P. Huntington, Jr. | R. P. Huntington, Jr., O. S. Campbell |
| 1891 | C. T. Lee.....        | C. T. Lee.....        | C. T. Lee and F. G. Beach             |
| 1892 | E. L. Hall.....       | E. L. Hall.....       | E. L. Hall and A. E. Wright           |
| 1893 | C. Hobart.....        | C. Hobart.....        | J. F. Talmage, Jr., and C. Hobart     |
| 1894 | A. E. Foote.....      | A. E. Foote.....      | John Howland and A. E. Foote          |
| 1895 | John Howland.....     | John Howland.....     | M. G. Chace and A. E. Foote           |
| 1896 | A. E. Foote.....      | A. E. Foote.....      | M. G. Chace and A. E. Foote           |
| 1897 | T. A. Driscoll.....   | T. A. Driscoll.....   | R. Hooker and C. P. Dodge             |
| 1899 | A. E. Foote.....      | A. E. Foote.....      | H. H. Hackett and J. A. Allen         |
| 1901 | Clarence Hobart.....  | Clarence Hobart.....  | C. Hobart and A. P. Dady              |
| 1902 | Clarence Hobart.....  | James Terry.....      | James Terry and F. E. Howard          |
| 1903 | James Terry.....      | James Terry.....      | James Terry and F. E. Howard          |
| 1904 | B. C. Wright.....     | B. C. Wright.....     | W. C. Grant and R. LeRoy              |
| 1905 | Karl H. Behr.....     | Karl H. Behr.....     | W. C. Grant and Robert LeRoy          |
| 1906 | Karl H. Behr.....     | Karl H. Behr.....     | W. C. Grant and T. R. Pell            |
| 1907 | T. R. Pell.....       | T. R. Pell.....       | R. LeRoy and T. R. Pell               |
| 1908 | T. R. Pell.....       | H. L. Westfall.....   | T. R. Pell and E. T. Gross            |
| 1909 | T. R. Pell.....       | G. F. Touchard.....   | T. R. Pell and W. C. Grant            |
| 1910 | T. R. Pell.....       | R. A. Holden, Jr..... | F. M. Watrous and R. A. Holden, Jr.   |
| 1911 | R. A. Holden, Jr..... | R. A. Holden, Jr..... | F. H. Harris and J. G. Nelson         |
| 1912 | F. H. Harris.....     | F. H. Harris.....     | A. H. Man, Jr., and E. W. Peaslee     |
| 1913 | A. H. Man, Jr.....    | A. H. Man, Jr.....    | C. E. Bacon and J. A. Richards        |
| 1914 | R. L. Murray.....     | R. L. Murray.....     | R. L. Murray and H. L. Hahn           |
| 1915 | F. H. Harris.....     | F. H. Harris.....     | J. A. Richards and W. S. Cushing      |
| 1916 | R. S. Stoddart.....   | R. S. Stoddart.....   | W. L. Ferris and F. H. Harris         |
| 1918 | W. Westbrook.....     | W. Westbrook.....     | R. L. James and W. Westbrook          |

1898, 1900 and 1917, no tournaments.

## MIDDLE STATES.

|      |                      |                      |                                   |
|------|----------------------|----------------------|-----------------------------------|
| 1885 | R. D. Sears.....     | R. D. Sears.....     | R. D. Sears and J. S. Clark       |
| 1886 | R. L. Beeckman.....  | R. L. Beeckman.....  | R. L. Beeckman and H. W. Slocum   |
| 1887 | R. L. Beeckman.....  | R. L. Beeckman.....  |                                   |
| 1888 | E. P. MacMullen..... | E. P. MacMullen..... |                                   |
| 1889 | H. A. Taylor.....    | H. A. Taylor.....    |                                   |
| 1890 | H. A. Taylor.....    | A. E. Wright.....    |                                   |
| 1891 | C. E. Sands.....     | C. E. Sands.....     |                                   |
| 1892 | R. Stevens.....      | R. Stevens.....      | E. P. MacMullen and C. Hobart     |
| 1893 | R. Stevens.....      | A. E. Foote.....     | D. Candler and J. F. Talmage, Jr. |
| 1894 | W. A. Larned.....    | W. A. Larned.....    | W. G. Parker and E. P. Fischer    |
| 1895 | W. A. Larned.....    | John Howland.....    | C. Hobart and E. P. Fischer       |
| 1896 | C. Hobart.....       | C. Hobart.....       | C. Hobart and R. D. Wrenn         |
| 1897 | W. A. Larned.....    | W. A. Larned.....    | L. E. Ware and G. P. Sheldon, Jr. |
| 1898 | M. D. Whitman.....   | M. D. Whitman.....   | L. E. Ware and J. D. Forbes       |
| 1899 | M. D. Whitman.....   | W. A. Larned.....    | Holcombe Ward and D. F. Davis     |
| 1900 | M. D. Whitman.....   | D. F. Davis.....     | Holcombe Ward and D. F. Davis     |
| 1901 | W. A. Larned.....    | W. A. Larned.....    | W. A. Larned and C. Hobart        |
| 1902 | Holcombe Ward.....   | Holcombe Ward.....   | Holcombe Ward and D. F. Davis     |
| 1903 | Holcombe Ward.....   | S. C. Millett.....   | R. D. and G. L. Wrenn             |
| 1904 | C. Hobart.....       | C. Hobart.....       | R. D. and G. L. Wrenn             |
| 1905 | F. B. Alexander..... | F. B. Alexander..... | F. B. Alexander and H. H. Hackett |
| 1906 | W. A. Larned.....    | W. A. Larned.....    | W. J. Clothier and W. A. Larned   |
| 1907 | W. A. Larned.....    | R. D. Little.....    | R. D. Little and H. H. Hackett    |
| 1908 | E. P. Larned.....    | E. P. Larned.....    | W. A. Larned and G. L. Wrenn, Jr. |
| 1909 | E. P. Larned.....    | W. F. Johnson.....   | W. A. Larned and G. L. Wrenn, Jr. |
| 1910 | N. W. Niles.....     | N. W. Niles.....     | H. H. Hackett and F. B. Alexander |
| 1911 | W. M. Hall.....      | W. M. Hall.....      | H. H. Hackett and F. B. Alexander |
| 1912 | W. F. Johnson.....   | W. F. Johnson.....   | H. H. Hackett and L. E. Mahan     |
| 1913 | G. F. Touchard.....  | G. F. Touchard.....  | G. F. Touchard and W. M. Washburn |
| 1914 | Karl H. Behr.....    | Karl H. Behr.....    | Karl H. Behr and T. R. Pell       |
| 1915 | Karl H. Behr.....    | H. Throckmorton..... | Karl H. Behr and T. R. Pell       |
| 1916 | T. R. Pell.....      | T. R. Pell.....      | Karl H. Behr and T. R. Pell       |
| 1917 | No tournament.       |                      |                                   |
| 1918 | W. M. Hall.....      | W. M. Hall.....      | Dr. W. Rosenbaum and E. A. Clark  |

## SOUTHERN STATES.

| YR.  | CHAMPION.              | TOUR'T WINNER     | DOUBLES CHAMPIONS.                  |
|------|------------------------|-------------------|-------------------------------------|
| 1886 | C. B. Davis            | C. B. Davis       | C. B. Davis and R. H. E. Porter     |
| 1887 | Leigh Bonsal           | Leigh Bonsal      | Leigh Bonsal and L. V. Lemoine      |
| 1888 | A. H. S. Post (Spring) | A. H. S. Post     | Leigh Bonsal and L. V. Lemoine      |
| 1888 | F. Mansfield (Fall)    | F. Mansfield      | F. Mansfield and F. L. V. Hoppin    |
| 1889 | F. Mansfield           | C. J. Post, Jr.   | C. J. Post, Jr., and M. F. Prosser  |
| 1890 | A. E. Wright           | A. E. Wright      |                                     |
| 1891 | E. L. Hall             | E. L. Hall        | M. R. Wright and H. M. Billings     |
| 1892 | E. L. Hall             | A. E. Wright      |                                     |
| 1893 | E. L. Hall             | M. G. Chace       | E. L. Hall and C. Hobart            |
| 1894 | W. G. Parker           | W. G. Parker      | W. G. Parker and E. P. Fischer      |
| 1895 | A. H. S. Post          | A. H. S. Post     | J. P. Paret and R. D. Thurber       |
| 1896 | J. P. Paret            | J. P. Paret       | J. C. Davidson and J. P. Paret      |
| 1897 | T. A. Driscoll         | T. A. Driscoll    | J. C. Davidson and J. P. Paret      |
| 1898 | J. C. Davidson         | J. C. Davidson    | J. C. Davidson and J. P. Paret      |
| 1899 | J. C. Davidson         | J. P. Paret       | J. C. Davidson and J. P. Paret      |
| 1900 | J. P. Paret            | J. P. Paret       | J. C. Davidson and J. P. Paret      |
| 1901 | R. D. Little           | R. D. Little      | R. D. Little and F. B. Alexander    |
| 1902 | R. D. Little           | F. Geoghegan      | J. P. Paret and W. C. Grant         |
| 1903 | F. Geoghegan           | F. Geoghegan      | W. C. Grant and R. LeRoy            |
| 1904 | H. F. Allen            | H. F. Allen       | J. C. Davidson and L. W. Glazebrook |
| 1905 | J. C. Davidson         | J. C. Davidson    | L. W. Glazebrook and W. A. Larned   |
| 1906 | R. G. Hunt             | R. G. Hunt        | B. M. Grant and N. Thornton         |
| 1907 | N. Thornton            | N. Thornton       | B. M. Grant and N. Thornton         |
| 1908 | N. Thornton            | H. G. Whitehead   | H. G. Whitehead and J. H. Winston   |
| 1909 | T. R. Pell             | T. R. Pell        | T. R. Pell and W. C. Grant          |
| 1910 | C. B. Doyle            | C. B. Doyle       | C. B. Doyle and H. E. Doyle         |
| 1911 | C. B. Doyle            | C. Smith          | C. B. Doyle and H. E. Doyle         |
| 1912 | C. Y. Smith            | C. Y. Smith       | C. Y. Smith and N. Thornton         |
| 1913 | N. Thornton            | N. Thornton       | J. B. Adoue and R. F. Shelton       |
| 1914 | I. C. Wright           | I. C. Wright      | I. C. Wright and J. B. Adoue        |
| 1915 | E. V. Carter, Jr.      | E. V. Carter, Jr. | B. M. Grant and N. Thornton         |
| 1916 | D. Watters             | D. Watters        | N. Emerson and L. Hardy             |
| 1917 | No tournament.         |                   |                                     |
| 1918 | C. Y. Smith            | C. Y. Smith       | B. M. Grant and N. Thornton         |

## WESTERN STATES.

|       |                  |                  |                                   |
|-------|------------------|------------------|-----------------------------------|
| 1887  | C. A. Chase      | C. A. Chase      | E. B. McLellan and B. F. Cummins  |
| 1888  | C. A. Chase      | E. B. McLellan   | E. B. McLellan and B. F. Cummins  |
| 1889  | C. A. Chase      | S. T. Chase      | C. A. Chase and S. T. Chase       |
| 1890  | C. A. Chase      | E. B. McLellan   | J. W. Carver and J. A. Ryerson    |
| 1891  | C. A. Chase      | S. T. Chase      | S. T. Chase and J. A. Ryerson     |
| 1892  | C. A. Chase      | J. A. Ryerson    | J. W. Carver and J. A. Ryerson    |
| 1893  | C. A. Chase      | E. Wrenn         | H. McCormick and S. McCormick     |
| 1894  | C. A. Chase      | C. B. Neel       | C. B. Neel and S. R. Neel         |
| 1895  | C. B. Neel       | C. B. Neel       | C. B. Neel and S. R. Neel         |
| 1896  | C. B. Neel       | G. L. Wrenn, Jr. | C. B. Neel and S. R. Neel         |
| 1897  | Krieh Collins    | Krieh Collins    | L. E. Ware and G. P. Sheldon, Jr. |
| 1898  | Krieh Collins    | Krieh Collins    | H. Ward and D. F. Davis           |
| 1899  | C. B. Neel       | C. B. Neel       | H. H. Hackett and J. A. Allen     |
| 1900  | Krieh Collins    | Krieh Collins    | F. B. Alexander and R. D. Little  |
| 1901  | R. D. Little     | R. D. Little     | R. D. Little and F. B. Alexander  |
| 1902  | Krieh Collins    | Krieh Collins    | Krieh Collins and L. H. Waidner   |
| 1903  | Krieh Collins    | A. C. Snow       | Krieh Collins and L. H. Waidner   |
| 1904  | Krieh Collins    | R. D. Little     | Krieh Collins and R. D. Little    |
| 1905  | Krieh Collins    | N. Emerson       | Krieh Collins and L. H. Waidner   |
| 1906  | Krieh Collins    | N. Emerson       | L. H. Waidner and N. Emerson      |
| 1907  | N. Emerson       | N. Emerson       | H. H. Hackett and F. B. Alexander |
| 1908  | N. Emerson       | L. H. Waidner    | L. H. Waidner and N. Emerson      |
| 1909  | M. Long          | M. Long          | T. Emerson and R. A. Holden, Jr.  |
| 1910  | T. C. Bundy      | T. C. Bundy      | L. H. Waidner and Paul Gardner    |
| 1911  | M. E. McLoughlin | M. E. McLoughlin | C. M. Bull, Jr., and H. C. Martin |
| 1912  | M. E. McLoughlin | T. C. Bundy      | W. T. Hayes and J. H. Winston     |
| 1913  | C. J. Griffin    | C. J. Griffin    | H. T. Eyford and R. H. Burdick    |
| 1914  | A. M. Squair     | A. M. Squair     | G. M. Church and D. Mathey        |
| 1915  | G. M. Church     | G. M. Church     | W. T. Hayes and R. H. Burdick     |
| 1916  | G. M. Church     | H. T. Byford     | W. T. Hayes and R. H. Burdick     |
| *1917 |                  | W. T. Hayes      | Samuel Hardy and C. S. Garland    |
| 1918  | W. T. Hayes      | W. T. Hayes      | W. T. Hayes and R. H. Burdick     |

\* Patriotic tournament without championships.

# Longwood Singles and Eastern Doubles Winners Since 1890

| YEAR. | SINGLES CHAMPION.     | WINNER OF TOURNAMENT.   | DOUBLES CHAMPIONS.                       |
|-------|-----------------------|-------------------------|--|
| 1890  | E. L. Hall.....       | E. L. Hall.....         | V. G. Hall and C. Hobart                 |
| 1891  | F. H. Hovey.....      | F. H. Hovey.....        | O. S. Campbell and R. P. Huntington, Jr. |
| 1892  | F. H. Hovey.....      | R. Stevens.....         | V. G. Hall and E. L. Hall                |
| 1893  | W. A. Larned.....     | W. A. Larned.....       | John Howland and A. E. Foote             |
| 1894  | W. A. Larned.....     | F. H. Hovey.....        | M. G. Chace and R. D. Wrenn              |
| 1895  | R. D. Wrenn.....      | R. D. Wrenn.....        | C. Hobart and F. H. Hovey                |
| 1896  | W. A. Larned.....     | W. A. Larned.....       | W. V. Eaves and H. A. Nisbet             |
| 1897  | M. D. Whitman.....    | M. D. Whitman.....      | G. L. Wrenn and M. D. Whitman            |
| 1898  | M. D. Whitman.....    | D. F. Davis.....        | Holcombe Ward and D. F. Davis            |
| 1899  | M. D. Whitman.....    | D. F. Davis.....        | H. H. Hackett and J. A. Allen            |
| 1900  | W. A. Larned.....     | W. A. Larned.....       | B. C. Wright and L. E. Ware              |
| 1901  | W. J. Clothier.....   | W. J. Clothier.....     | R. F. Doherty and H. L. Doherty          |
| 1902  | W. A. Larned.....     | W. A. Larned.....       | H. Ward and L. E. Ware                   |
| 1903  | W. A. Larned.....     | W. A. Larned.....       | H. Ward and B. C. Wright                 |
| 1904  | W. A. Larned.....     | C. Hobart.....          | F. B. Alexander and H. H. Hackett        |
| 1905  | W. A. Larned.....     | Karl H. Behr.....       | F. B. Alexander and H. H. Hackett        |
| 1906  | W. A. Larned.....     | C. Hobart.....          | W. A. Larned and W. J. Clothier          |
| 1907  | W. A. Larned.....     | R. D. Little.....       | R. C. Wright and R. D. Little            |
| 1908  | W. A. Larned.....     | W. J. Clothier.....     | N. W. Niles and A. S. Dabney, Jr.        |
| 1909  | W. A. Larned.....     | M. E. McLoughlin.....   | R. Bishop and E. H. Whitney              |
| 1910  | E. P. Larned.....     | E. P. Larned.....       | G. F. Touchard and R. D. Little          |
| 1911  | M. E. McLoughlin..... | M. E. McLoughlin.....   | W. J. Clothier and G. P. Gardner, Jr.    |
| 1912  | W. M. Johnston.....   | W. M. Johnston.....     | G. F. Touchard and W. M. Washburn        |
| 1913  | M. E. McLoughlin..... | R. N. Williams, 2d..... | K. H. Behr and T. R. Pell                |
| 1914  | M. E. McLoughlin..... | W. M. Johnston.....     | R. N. Williams, 2d, and W. M. Washburn   |
| 1915  | M. E. McLoughlin..... | R. N. Williams, 2d..... | G. M. Church and W. E. Davis             |
| 1916  | W. M. Johnston.....   | W. M. Johnston.....     | W. T. Tilden, Jr., and R. M. Beck        |
| 1917* | .....                 | .....                   | Percy Osborne and Wallace Rhoades        |
| 1918  | .....                 | .....                   | .....                                    |

\*Patriotic tournament without championships.

## Metropolitan Champions Since 1896

| Yr.  | SINGLES CHAMPION.   | DOUBLES CHAMPIONS.                 | YR.   | SINGLES CHAMPION.  | DOUBLES CHAMPIONS.                 |
|------|---------------------|------------------------------------|-------|--------------------|------------------------------------|
| 1896 | E. P. Fischer.....  | E. P. Fischer and R. D. Thurber    | 1908  | Ross Burchard..... | H. H. Hackett and F. B. Alexander  |
| 1897 | Stephen C. Millet.. | E. P. Fischer and W. Gordon Parker | 1909  | F. C. Inman.....   | Henry Torrance and Otto H. Hincke  |
| 1898 | E. P. Fischer.....  | E. P. Fischer and O. M. Bostwick   | 1910  | W. A. Larned.....  | H. H. Hackett and F. B. Alexander  |
| 1899 | E. P. Fischer.....  | H. H. Hackett and John A. Allen    | 1911  | F. C. Inman.....   | Lyle Mahan and G. F. Touchard      |
| 1900 | E. P. Fischer.....  | H. H. Hackett and John A. Allen    | 1912  | R. D. Little.....  | H. H. Hackett and W. Merrill Hall  |
| 1901 | R. D. Little.....   | R. D. Little and F. B. Alexander   | 1913  | W. M. Washburn..   | W. M. Washburn and C. M. Bull, Jr. |
| 1902 | H. H. Hackett....   | H. H. Hackett and E. P. Fischer    | 1914  | R. L. Murray.....  | G. M. Church and Dean Mathey       |
| 1903 | Holcombe Ward...    | Robert LeRoy and H. F. Allen       | 1915  | W. M. Washburn..   | H. H. Hackett and W. M. Hall       |
| 1904 | Holcombe Ward...    | H. H. Hackett and Robert LeRoy     | 1916  | G. M. Church.....  | G. M. Church and Dean Mathey       |
| 1905 | F. B. Alexander...  | H. H. Hackett and F. B. Alexander  | 1917* | W. M. Hall.....    | F. C. Baggs and R. L. Baggs        |
| 1906 | F. B. Alexander...  | H. H. Hackett and F. B. Alexander  | 1918  | Ichiya Kumagae...  | Dr. W. Rosenbaum and F. C. Baggs   |
| 1907 | F. B. Alexander...  | H. H. Hackett and F. B. Alexander  | ..... | .....              | .....                              |

\*Patriotic tournament without championships.

## Interscholastic Champions Since 1891

| Year. | Winner.                       | School.         | Year. | Winner.                          | School.         |
|-------|-------------------------------|-----------------|-------|----------------------------------|-----------------|
| 1891  | R. D. Wrenn (Harvard).....    | Cam. Latin      | 1904  | N. W. Niles (Harvard).....       | Lowell High     |
| 1892  | M. G. Chace (Harvard).....    | Univ. Grammar   | 1905  | N. W. Niles (Harvard).....       | Wellesley High  |
| 1893  | C. R. Budlong (Harvard).....  | Providence High | 1906  | J. Allan Ross (Univ. of Chicago) | Phillips Exeter |
| 1894  | W. C. Parker (Columbia).....  | Tutor, N. Y.    | 1907  | W. F. Johnson (Univ. of Penn.)   | St. Mark's      |
| 1895  | L. E. Ware (Harvard).....     | Roxbury Latin   | 1908  | Dean Mathey (Princeton).....     | .....           |
| 1896  | Rex Finke (Yale).....         | Hornkiss        | 1909  | M. E. McLoughlin (California)    | .....           |
| 1897  | Rex Finke (Yale).....         | Hornkiss        | 1910  | E. H. Whitney (Harvard).....     | .....           |
| 1898  | B. C. Wright (Harvard).....   | Hopkisson       | 1911  | G. M. Church (Princeton).....    | .....           |
| 1899  | B. C. Wright (Harvard).....   | Hopkisson       | 1912  | C. B. Herd (Harvard).....        | .....           |
| 1900  | I. C. Wright (Harvard).....   | Hopkisson       | 1913  | G. C. Caner (Harvard).....       | .....           |
| 1901  | E. P. Larned (Princeton)..... | Chatham Prep.   | 1914  | L. Beekman (Columbia).....       | .....           |
| 1902  | H. H. Whitman (Harvard).....  | Volkman         | 1915  | H. A. Throckmorton (Princeton)   | .....           |
| 1903  | K. H. Behr (Princeton).....   | Lawrenceville   | ..... | .....                            | .....           |



## Champions of the Pacific Coast

| YR.  | MEN'S SINGLES.    | WINNER OF TOURNAMENT. | MEN'S DOUBLES.                   |
|------|-------------------|-----------------------|----------------------------------|
| 1889 | W. H. Taylor, Jr. | W. H. Taylor, Jr.     |                                  |
| 1890 | W. H. Taylor, Jr. | C. R. Yates           | W. S. McGavin and J. S. Tobin    |
| 1891 | W. H. Taylor, Jr. | C. P. Hubbard         | C. P. Hubbard and H. H. Haight   |
| 1892 | W. H. Taylor, Jr. | C. P. Hubbard         | Sumner Hardy and Samuel Hardy    |
| 1893 | T. A. Driscoll    | T. A. Driscoll        | Sumner Hardy and Samuel Hardy    |
| 1894 | Samuel Hardy      | Samuel Hardy          | T. A. Driscoll and G. B. DeLong  |
| 1895 | Samner Hardy      | Sumner Hardy          | Sumner Hardy and Samuel Hardy    |
| 1896 | Samuel Hardy      | Samuel Hardy          | G. F. Whitney and R. N. Whitney  |
| 1897 | G. F. Whitney     | G. F. Whitney         | Sumner Hardy and Samuel Hardy    |
| 1898 | Sumner Hardy      | Sumner Hardy          | Sumner Hardy and Samuel Hardy    |
| 1899 | G. F. Whitney     | G. F. Whitney         | Sumner Hardy and Samuel Hardy    |
| 1900 | G. F. Whitney     | Sumner Hardy          | G. F. Whitney and R. N. Whitney  |
| 1901 | G. F. Whitney     | R. N. Whitney         | G. F. Whitney and R. N. Whitney  |
| 1902 | L. R. Freeman     | L. R. Freeman         | L. R. Freeman and A. E. Bell     |
| 1903 | A. E. Bell        | A. E. Bell            | L. R. Freeman and A. E. Bell     |
| 1904 | J. D. MacGavin    | J. D. MacGavin        | W. Allen and G. L. Baker         |
| 1905 | G. Janes          | G. Janes              | S. Sinsbaugh and H. Braley       |
| 1906 | M. H. Long        | M. H. Long            | C. Foley and F. Adams            |
| 1907 | M. E. McLoughlin  | M. E. McLoughlin      | M. E. McLoughlin and G. Janes    |
| 1908 | M. H. Long        | M. H. Long            | M. E. McLoughlin and G. Janes    |
| 1909 | G. Janes          | G. Janes              | M. E. McLoughlin and G. Janes    |
| 1910 | M. H. Long        | M. H. Long            | T. C. Bundy and T. Hendrick      |
| 1911 | M. E. McLoughlin  | M. E. McLoughlin      | M. E. McLoughlin and T. C. Bundy |
| 1912 | M. E. McLoughlin  | M. E. McLoughlin      | M. E. McLoughlin and T. C. Bundy |
| 1913 | W. M. Johnston    | W. M. Johnston        | J. R. Strachan and C. J. Griffin |
| 1914 | W. M. Johnston    | W. M. Johnston        | C. J. Griffin and W. M. Johnston |
| 1915 | H. L. Hahn        | H. L. Hahn            | W. M. Johnston and C. J. Griffin |
| 1916 | W. M. Johnston    | W. M. Johnston        | M. E. McLoughlin and W. Dawson   |
| 1917 | *                 | W. M. Johnston        | N. B. Browne and C. A. Wayne     |
| 1918 | Roland Roberts    | Roland Roberts        | N. B. Browne and Frank Wine      |

| YR.  | WOMEN'S SINGLES       | WOMEN'S DOUBLES                              |
|------|-----------------------|--|
| 1892 | Miss Susan D. Morgan  |  |
| 1893 | Miss Bee Hooper       |  |
| 1894 | Miss Bee Hooper       |  |
| 1895 | Miss Bee Hooper       |  |
| 1896 | Miss Bee Hooper       |  |
| 1897 | Miss Marion Jones     |  |
| 1898 | Miss Miriam Hall      |  |
| 1899 | Miss Violet Sutton    |  |
| 1900 | Miss Violet Sutton    |  |
| 1901 | Miss May Sutton       | Misses May and Violet Sutton                 |
| 1902 | Miss May Sutton       | Misses May and Violet Sutton                 |
| 1903 | Miss May Sutton       | Misses May and Violet Sutton                 |
| 1904 | Miss May Sutton       | Misses Dobbins and F. Sutton                 |
| 1905 | Miss May Sutton       |  |
| 1906 | Miss Hazel Hotchkiss  | Misses Hazel Hotchkiss and Ethel Ratcliffe   |
| 1907 | Miss Florence Sutton  | Miss Florence Sutton and Mrs. Bruce          |
| 1908 | Miss May Sutton       | Miss May Sutton and Miss Ryan                |
| 1909 | Miss Florence Sutton  | Misses Hazel Hotchkiss and G. Myer           |
| 1910 | Miss May Sutton       | Misses Hazel Hotchkiss and G. Myer           |
| 1911 | Miss May Sutton       | Misses May Sutton and Mary Browne            |
| 1912 | Miss Florence Sutton  | Miss Helen Baker and Mrs. Max Niemeyer       |
| 1913 | Miss Sarita Van Vliet | Misses Sarita Van Vliet and Anita Myers      |
| 1914 | Mrs. H. A. Niemeyer   | Misses E. Tennant and C. Tarilton            |
| 1915 | Mrs. G. W. Wightman   | Miss Molla Bjurstedt and Mrs. G. W. Wightman |
| 1916 | Miss Helen Baker      | Misses Helen Baker and Anita Myers           |
| 1917 | *Mrs. G. W. Wightman  | No doubles competition.                      |
| 1918 | Miss Anita Myers      | Mrs. J. C. Cushing and Miss Carmen Tarilton  |

\*Patriotic tournament without championships.

(See following page).



## English Champions Since 1877

| YEAR   | CHAMPION                  | WINNER ALL-COMERS* | RUNNER-UP        |
|--------|---------------------------|--------------------|------------------|
| 1877.. | S. W. Gore.               | S. W. Gore.        | W. Marshall      |
| 1878.. | P. F. Hadow.              | P. F. Hadow.       | W. Eskiné        |
| 1879*. | J. T. Hartley.            | J. T. Hartley.     | V. "St. Leger"   |
| 1880.. | J. T. Hartley.            | H. F. Lawford.     | O. E. Woodhouse  |
| 1881.. | W. Renshaw.               | W. Renshaw.        | R. T. Richardson |
| 1882.. | W. Renshaw.               | E. Renshaw.        | R. T. Richardson |
| 1883.. | W. Renshaw.               | E. Renshaw.        | D. Stewart       |
| 1884.. | W. Renshaw.               | H. F. Lawford.     | C. W. Grintstead |
| 1885.. | W. Renshaw.               | H. F. Lawford.     | E. Renshaw       |
| 1886.. | W. Renshaw.               | H. F. Lawford.     | E. Renshaw       |
| 1887*. | H. F. Lawford.            | H. F. Lawford.     | E. W. Lewis      |
| 1888.. | E. Renshaw.               | E. Renshaw.        | H. S. Barlow     |
| 1889.. | W. Renshaw.               | W. Renshaw.        | H. S. Barlow     |
| 1890.. | W. J. Hamilton.           | W. J. Hamilton.    | J. Pim           |
| 1891*. | W. Baddeley.              | W. Baddeley.       | E. W. Lewis      |
| 1892.. | W. Baddeley.              | W. Baddeley.       | H. S. Mahony     |
| 1893.. | J. Pim.                   | J. Pim.            | E. W. Lewis      |
| 1894.. | J. Pim.                   | W. Baddeley.       | E. W. Lewis      |
| 1895*. | W. Baddeley.              | W. Baddeley.       | W. V. Eaves      |
| 1896.. | H. S. Mahony.             | H. S. Mahony.      | W. V. Eaves      |
| 1897.. | R. F. Doherty.            | R. F. Doherty.     | W. V. Eaves      |
| 1898.. | R. F. Doherty.            | H. L. Doherty.     | W. V. Eaves      |
| 1899.. | R. F. Doherty.            | A. W. Gore.        | U. S. Mahony     |
| 1900.. | R. F. Doherty.            | S. H. Smith.       | S. H. Smith      |
| 1901.. | A. W. Gore.               | A. W. Gore.        | A. W. Gore       |
| 1902.. | H. L. Doherty.            | H. L. Doherty.     | C. P. Dixon      |
| 1903.. | H. L. Doherty.            | F. L. Risleley.    | M. J. G. Ritchie |
| 1904.. | H. L. Doherty.            | F. L. Risleley.    | M. J. G. Ritchie |
| 1905.. | H. L. Doherty.            | N. E. Brookes.     | M. J. G. Ritchie |
| 1906.. | H. L. Doherty.            | F. L. Risleley.    | N. J. G. Ritchie |
| 1907*. | N. E. Brookes.            | N. E. Brookes.     | S. H. Smith      |
| 1908*. | A. W. Gore.               | A. W. Gore.        | A. W. Gore       |
| 1909.. | A. W. Gore.               | M. J. G. Ritchie.  | A. W. Gore       |
| 1910.. | A. F. Wilding.            | A. F. Wilding.     | H. Roper Barrett |
| 1911.. | A. F. Wilding.            | M. Roper Barrett.  | H. Roper Barrett |
| 1912.. | A. F. Wilding.            | A. W. Gore.        | Beals C. Wright  |
| 1913.. | A. F. Wilding.            | M. E. McLoughlin.  | C. P. Dixon      |
| 1914.. | N. E. Brookes.            | N. E. Brookes.     | A. H. Gobert     |
| 1915.. | No matches, 1915 to 1918. |                    | S. N. Doust      |
|        |                           |                    | O. Froltzhelm    |

\*The holder did not defend the title.

# English Doubles Champions Since 1879

| YEAR   | CHAMPIONS                          | WINNER ALL-COMERS*                  | RUNNERS-UP                          |
|--------|------------------------------------|-------------------------------------|-------------------------------------|
| 1879   | L. R. Erskine and H. F. Lawford.   | L. R. Erskine and H. F. Lawford.    | F. Durrant and G. E. Tabor          |
| 1880   | W. Renshaw and E. Renshaw.         | W. Renshaw and E. Renshaw.          | O. E. Woodhouse and C. J. Cole      |
| 1881   | W. Renshaw and E. Renshaw.         | W. Renshaw and E. Renshaw.          | W. J. Down and H. Vaughan           |
| 1882   | J. T. Hartley and R. T. Richardson | J. T. Hartley and R. T. Richardson  | J. G. Horn and C. B. Russell        |
| 1883   | C. W. Grinstead and C. E. Weldon.  | C. W. Grinstead and C. E. Weldon.   | E. L. Williams and E. W. Lewis      |
| 1884   | W. Renshaw and E. Renshaw.         | W. Renshaw and E. Renshaw.          | A. J. Stanley and C. E. Farrer      |
| 1885   | W. Renshaw and E. Renshaw.         | C. E. Farrer and A. J. Stanley.     | P. B. Lyon and H. W. Wilberforce    |
| 1886†  | W. Renshaw and E. Renshaw.         | P. B. Lyon and H. W. Wilberforce.   | J. H. Crisp and E. Barratt Smith    |
| 1887   | P. B. Lyon and H. W. Wilberforce.  | W. Renshaw and E. Renshaw.          | E. G. Meers and A. G. Ziffo         |
| 1888   | W. Renshaw and E. Renshaw.         | E. W. Lewis and G. W. Hillyard.     | E. W. Gore and G. R. Newburn        |
| 1889   | W. Renshaw and E. Renshaw.         | J. Pim and F. O. Stoker.            | E. W. Lewis and G. W. Hillyard      |
| 1890*  | J. Pim and F. O. Stoker.           | W. Bradley and H. Bradley.          | E. Renshaw and H. S. Barlow         |
| 1891*  | W. Bradley and H. Bradley.         | H. S. Barlow and E. W. Lewis.       | J. Pim and H. S. Mahony             |
| 1892   | H. S. Barlow and E. W. Lewis.      | J. Pim and F. O. Stoker.            | W. Baddeley and H. Baddeley         |
| 1893   | J. Pim and F. O. Stoker.           | W. Baddeley and H. Baddeley.        | H. S. Barlow and C. H. Martin       |
| 1894   | W. Baddeley and H. Baddeley.       | E. W. Lewis and W. V. Eaves.        | W. G. Bailey and C. F. Simond       |
| 1895   | W. Baddeley and H. Baddeley.       | R. F. Doherty and H. A. Nisbet.     | E. R. Allen and C. G. Allen         |
| 1896   | W. Baddeley and H. Baddeley.       | R. F. Doherty and H. L. Doherty.    | S. H. Smith and C. H. L. Cazalet    |
| 1897   | R. F. Doherty and H. L. Doherty.   | H. A. Nisbet and C. Hobart.*        | S. H. Smith and G. W. Hillyard      |
| 1898   | R. F. Doherty and H. L. Doherty.   | H. A. Nisbet and C. Hobart.*        | A. W. Gore and H. R. Barrett        |
| 1899   | R. F. Doherty and H. L. Doherty.   | H. A. Nisbet and H. R. Barrett.     | S. H. Smith and F. L. Riseley       |
| 1900   | R. F. Doherty and H. L. Doherty.   | D. F. Davis and H. Ward.*           | S. H. Smith and F. L. Riseley       |
| 1901   | R. F. Doherty and H. L. Doherty.   | S. H. Smith and F. L. Riseley.      | H. R. Barrett and G. M. Simond      |
| 1902   | S. H. Smith and F. L. Riseley.     | R. F. Doherty and H. L. Doherty.    | G. W. Hillyard and C. H. L. Cazalet |
| 1903   | R. F. Doherty and H. L. Doherty.   | S. H. Smith and F. L. Riseley.      | H. S. Mahony and M. J. G. Ritchie   |
| 1904   | R. F. Doherty and H. L. Doherty.   | S. H. Smith and F. L. Riseley.      | A. W. Gore and G. A. Cardia         |
| 1905   | R. F. Doherty and H. L. Doherty.   | S. H. Smith and F. L. Riseley.      | N. E. Brookes and A. W. Dunlop      |
| 1906   | S. H. Smith and F. L. Riseley.     | S. H. Smith and F. L. Riseley.      | C. H. L. Cazalet and G. M. Simond   |
| 1907*  | N. E. Brookes and A. F. Wilding.   | N. E. Brookes and A. F. Wilding.    | Beals C. Wright and K. H. Behr.†    |
| 1908*  | M. J. G. Ritchie and A. F. Wilding | M. J. G. Ritchie and A. F. Wilding  | A. W. Gore and H. R. Barrett        |
| 1909*  | A. W. Gore and H. R. Barrett.      | A. W. Gore and H. R. Barrett.       | H. A. Parker and S. N. Doubt        |
| 1910   | M. J. G. Ritchie and A. F. Wilding | M. J. G. Ritchie and A. F. Wilding. | K. Powell and R. B. Powell          |
| 1911   | Max Decugis and A. H. Gobert.      | Max Decugis and A. H. Gobert.       | J. C. Parke and S. Hardy            |
| 1912   | H. R. Barrett and C. P. Dixon.     | H. R. Barrett and C. P. Dixon.      | J. C. Parke and A. E. Beamish       |
| 1913   | H. R. Barrett and C. P. Dixon.     | F. W. Kabé and H. Kleinschroth.     | J. C. Parke and A. E. Beamish       |
| 1914.. | N. E. Brookes and A. F. Wilding.   | N. E. Brookes and A. F. Wilding.    | F. G. Lowe and A. H. Lowe           |
| 1915.. | No matches, 1915 to 1918.          |                                     |                                     |

\*The holders did not defend the title. †Challenge round first introduced. ‡Of the United States.

## English Lady Champions Since 1884

| YEAR   | CHAMPION—SINGLES          | WINNER ALL-COMERS    | RUNNER-UP           | CHAMPIONS—DOUBLES                          |
|--------|---------------------------|----------------------|---------------------|--|
| 1884.  | Miss Maud Watson.         | Miss M. Watson.      | Miss Watson.        | Mrs. Watts and Mrs. Braeewell              |
| 1885.  | Miss Maud Watson.         | Miss M. Watson.      | Miss Bingley.       | Miss L. Dod and Miss M. Laurishe           |
| 1886.  | Miss Bingley.             | Miss Bingley.        | Miss Tabor.         | Miss L. Dod and Miss M. Laurishe           |
| 1887.  | Miss L. Dod.              | Miss L. Dod.         | Miss C. J. Cole.    | Miss L. Dod and Miss M. Laurishe           |
| 1888.  | Miss L. Dod.              | Mrs. Hillyard.       | Miss Howes.         | Miss M. Steedman and Miss E. Steedman      |
| 1889*. | Mrs. Hillyard.            | Mrs. Hillyard.       | Miss L. Rice.       | Miss M. Steedman and Miss B. Marriott      |
| 1890*. | Miss Rice.                | Miss L. Dod.         | Miss Jacks.         | Miss L. Marriott and Miss M. Marriott      |
| 1891*. | Miss L. Dod.              | Miss L. Dod.         | Mrs. Hillyard.      | Miss Jackson and Miss Crofton              |
| 1892.  | Miss L. Dod.              | Mrs. Hillyard.       | Miss Shackle.       | Mrs. Hillyard and Miss Steedman            |
| 1893.  | Mrs. Hillyard.            | Mrs. Hillyard.       | Miss Shackle.       | Mrs. Hillyard and Miss Steedman            |
| 1894*. | Mrs. Hillyard.            | Mrs. Hillyard.       | Miss Austin.        | Mrs. Hillyard and Miss Steedman            |
| 1895*. | Miss C. Cooper.           | Miss C. Cooper.      | Miss Jackson.       | Mrs. Hillyard and Miss Steedman            |
| 1896.  | Miss C. Cooper.           | Mrs. Pickering.      | Miss Austin.        | Mrs. Hillyard and Miss Steedman            |
| 1897.  | Mrs. Hillyard.            | Mrs. Hillyard.       | Mrs. Pickering.     | Mrs. Hillyard and Mrs. Pickering           |
| 1898*. | Miss C. Cooper.           | Miss C. Cooper.      | Miss Martin.        | Miss Steedman and Miss R. Dvay             |
| 1899.  | Mrs. Hillyard.            | Mrs. Hillyard.       | Mrs. Durlacher.     | Mrs. Durlacher and Miss Steedman           |
| 1900.  | Mrs. Hillyard.            | Miss C. Cooper.      | Miss Martin.        | Mrs. Pickering and Miss Robb               |
| 1901.  | Mrs. Sterry.              | Mrs. Sterry.         | Miss Martin.        | Mrs. Pickering and Miss Robb               |
| 1902.  | Miss M. E. Robb.          | Mrs. Sterry.         | Miss A. M. Morton.  | Mrs. Pickering and Miss Robb               |
| 1903*. | Miss D. K. Douglass.      | Miss M. E. Robb.     | Miss A. M. Morton.  | Miss D. K. Douglass and Miss E. W. Thomson |
| 1904.  | Miss D. K. Douglass.      | Miss D. K. Douglass. | Miss E. W. Thomson. | Miss D. K. Douglass and Miss E. W. Thomson |
| 1905.  | Miss M. Sutton†.          | Mrs. Sterry.         | Miss A. M. Morton.  | Miss D. K. Douglass and Miss E. W. Thomson |
| 1906.  | Miss D. K. Douglass.      | Miss M. Sutton†.     | Miss C. M. Wilson.  | Miss C. M. Wilson and Miss H. Lane         |
| 1907.  | Miss M. Sutton†.          | Miss D. K. Douglass. | Mrs. Sterry.        | Mrs. Hillyard and Miss C. Meyer            |
| 1908*. | Mrs. Sterry.              | Miss M. Sutton†.     | Miss C. M. Wilson.  | Mrs. Hillyard and Miss C. Meyer            |
| 1909*. | Miss D. Boothby.          | Mrs. Sterry.         | Miss C. M. Wilson.  | Mrs. Sterry and Miss Garth                 |
| 1910.  | Mrs. R. L. Chambers.      | Miss D. Boothby.     | Miss A. M. Morton.  | Miss H. Aitchison and Mrs. Tuckey          |
| 1911.  | Mrs. R. L. Chambers.      | Mrs. R. L. Chambers. | Miss E. G. Johnson. | Mrs. Hudleston and Miss Garth              |
| 1912*. | Mrs. Larcombe.            | Miss D. Boothby.     | Mrs. Hannam.        | Mrs. Larcombe and Miss W. A. Longhurst     |
| 1913*. | Mrs. E. L. Chambers.      | Mrs. Larcombe.       | Mrs. Sterry.        | Mrs. Larcombe and Miss W. A. Longhurst     |
| 1914.  | Mrs. R. L. Chambers.      | Mrs. R. L. Chambers. | Mrs. McNair.        | Mrs. Larcombe and Miss W. A. Longhurst     |
| 1915.  | No matches, 1915 to 1915. | Mrs. Larcombe.       | Miss E. Ryan†.      | No doubles matches.                        |

\*The holder did not defend the title. †Of the United States.

# Champions of the South of France

## GENTLEMEN'S SINGLES.

|                    |                      |                     |
|--------------------|----------------------|---------------------|
| 1899—H. L. Doherty | 1905—H. L. Doherty   | 1911—A. F. Wilding  |
| 1900—H. L. Doherty | 1906—H. L. Doherty   | 1912—M. Decugis     |
| 1901—H. L. Doherty | 1907—A. F. Wilding   | 1913—M. Decugis     |
| 1902—H. L. Doherty | 1908—A. F. Wilding   | 1914—A. F. Wilding  |
| 1903—H. L. Doherty | 1909—F. B. Alexander | 1915-18—No matches. |
| 1904—H. L. Doherty | 1910—M. Decugis      | 1919—M. Decugis     |

## LADIES' SINGLES

|                         |                               |                               |
|-------------------------|-------------------------------|-------------------------------|
| 1899—Miss Brooksmith    | 1906—Miss Lowther             | 1911—Frl. von Krohn           |
| 1900—Ctess. Schulenburg | 1907—Miss Eastlake-Smith      | 1912—Miss J. Tripp            |
| 1901—Mrs. Hillyard      | 1908—Mrs. R. Lambert Chambers | 1913—Frl. von Krohn           |
| 1902—Ctess. Schulenburg | 1909—Ctess. Schulenburg       | 1914—Mrs. R. Lambert Chambers |
| 1903—Miss Lowther       | 1910—Miss R. V. Salusbury     | 1915-18—No matches.           |
| 1904—Ctess. Schulenburg |                               | 1918—Mlle. S. Lenglen         |
| 1905—Miss Wilson        |                               |                               |

## GENTLEMEN'S DOUBLES

|                                      |  |
|--------------------------------------|--|
| 1900—R. F. Doherty, H. L. Doherty    | 1909—F. B. Alexander, M. J. G. Ritchie |
| 1901—R. F. Doherty, H. L. Doherty    | 1910—M. Decugis, M. J. G. Ritchie      |
| 1902—R. F. Doherty, H. L. Doherty    | 1911—A. F. Wilding, M. J. G. Ritchie   |
| 1903—R. F. Doherty, H. L. Doherty    | 1912—M. Decugis, M. Germot             |
| 1904—R. F. Doherty, H. L. Doherty    | 1913—F. W. Rahe, H. Kleinschroth       |
| 1905—R. F. Doherty, H. L. Doherty    | 1914—A. F. Wilding, C. Biddle          |
| 1906—H. L. Doherty, Dr. W. V. Eaves  | 1915-18—No matches.                    |
| 1907—H. L. Doherty, M. J. G. Ritchie | 1919—M. Decugis, G. Mansel             |
| 1908—A. F. Wilding, M. J. G. Ritchie |  |

## MIXED DOUBLES

|  |                                     |
|--|-------------------------------------|
| 1903—Ctess. Schulenburg, R. F. Doherty       | 1910—Miss Brooksmith, A. Holmes     |
| 1904—Ctess. Schulenburg, R. F. Doherty       | 1911—Mme. and M. Max Decugis        |
| 1905—Ctess. Schulenburg, R. F. Doherty       | 1912—Miss J. Tripp, A. Wallis-Myers |
| 1906—Ctess. Schulenburg, H. L. Doherty       | 1913—Miss E. Ryan, Count Salm       |
| 1907—Miss Eastlake-Smith, A. F. Wilding      | 1914—Miss E. Ryan, M. Decugis       |
| 1908—Mrs. R. Lambert Chambers, A. F. Wilding | 1915-18—No matches.                 |
| 1909—Ctess. Schulenburg, H. L. Doherty       | 1919—Mlle. Lenglen, M. Decugis      |

# Nice Lawn Tennis Club Champions

## GENTLEMEN'S SINGLES

|                        |                        |                       |
|------------------------|------------------------|-----------------------|
| 1895—F. L. Fassitt     | 1901—Lemaire de Warzee | 1907—M. J. G. Ritchie |
| 1896—Count de Robiglio | 1902—E. R. Allen       | 1908—R. J. Stone      |
| 1897—S. V. R. Drapes   | 1903—M. J. G. Ritchie  | 1909—F. B. Alexander  |
| 1898—A. Chaliar        | 1904—M. J. G. Ritchie  | 1910—A. Holmes        |
| 1899—Lemaire de Warzee | 1905—F. B. Alexander   | 1911—Count Salm       |
| 1900—Lemaire de Warzee | 1906—E. R. Allen       | 1912—Count Salm       |

## LADIES' SINGLES

|                       |                         |                           |
|-----------------------|-------------------------|---------------------------|
| 1895—Miss Bernard     | 1902—Ctess. Schulenburg | 1909—Miss R. V. Salusbury |
| 1896—Mrs. Booth       | 1903—Miss Brooksmith    | 1910—Mrs. Nutcombe Quicke |
| 1897—Miss Brooksmith  | 1904—Mlle. de Robiglio  | 1911—Mrs. Nutcombe Quicke |
| 1898—Miss Brooksmith  | 1905—Miss Warden        | 1912—Mrs. Nutcombe Quicke |
| 1899—                 | 1906—Miss Warden        |                           |
| 1900—Mlle. G. Chaliar | 1907—Miss B. Darbyshire |                           |
| 1901—Miss Brooksmith  | 1908—Miss E. Dillon     |                           |

## GENTLEMEN'S DOUBLES

|                                  |                             |
|----------------------------------|-----------------------------|
| 1910—E. Gwynne-Evans, W. Caudery | 1912—Count Salm, W. Caudery |
| 1911—Count Salm, C. Gault,       |                             |

## PART II

# United States National Lawn Tennis Association

Annual Meeting, Officers, Committees,  
Constitution and By-Laws, Resolutions,  
Rules for National Championships, Rules  
for Ranking, National Umpires' Associ-  
ation, Fixtures, List of Member Clubs  
and Associations, Davis Cup Regulations.

### CONTENTS.

|   | Page |
|---|------|
| Annual Meeting .....  | 207  |
| Officers .....  | 209  |
| Committees for 1919.....  | 211  |
| Constitution .....  | 212  |
| By-Laws .....   | 217  |
| Qualifications for Entry in the National Singles Championship.            | 219  |
| National Doubles Championship.....  | 219  |
| Regulations Governing Junior, Boys' and Girls' Tournaments,<br>1919 ..... | 219  |
| National Umpires' Association.....  | 220  |
| Rules for Ranking.....  | 221  |
| Applications for Tournaments.....   | 224  |
| Colleges Endorse Tennis.....  | 224  |
| Amateur Rule .....  | 224  |
| Davis Cup .....   | 225  |
| Prizes .....  | 225  |
| Fixtures for 1919.....  | 226  |
| Club Members .....  | 229  |
| Association Members .....   | 238  |
| Park Association Members.....   | 240  |
| Davis Cup Regulations.....  | 241  |
| Laws of Lawn Tennis—Part III.....   | 245  |



EDWIN F. TORREY,  
Clinton, New York.

Secretary United States National Lawn Tennis Association.



## Annual Meeting

The thirty-eighth annual meeting of the United States Lawn Tennis Association was marked by an unusually harmonious atmosphere, resulting, no doubt, from the successful termination of the war and the general feeling that discord would be out of place. As a consequence the routine business of the meeting was transacted with dispatch, returning president Major George T. Adee presiding in his usual capable manner.

The reports of the Secretary, the Treasurer, the Investment Committee, and the Field Secretary were read and approved. Special committees then reported, Vice-President Myrick speaking for the Tennis Ambulance Committee. A. Massford gave the Men's Ranking Committee report, including the ranking of women. After some discussion the committee was instructed to include in its future reports the ranking of juniors and boys, while the Women's Subcommittee, in charge of the women's ranking, was requested to rank the girls. The plan of holding sectional doubles was resumed. The committee recommended that the challenge round be included as part of the tournament, which was allotted for 1919 to the Longwood Cricket Club of Boston. The Committee on the Development of Juniors and Boys, which throughout the war received the active co-operation of Vice-President Myrick, made a report which met with general approval. Over fifty successful tournaments had been held and substantial progress made. After considerable discussion and a hurried meeting of the committee, a change was made in the rule regulating the age of the contestants. Junior championships were made eligible to juniors who have not reached their eighteenth birthday prior to March of the year of competition, while for boys the time was fixed at their fifteenth birthday.

Chairman Dionne of the Ball Committee made several commendatory remarks relative to the quality of the balls adopted for use in the national championships and recommended competition among ball manufacturers.

The Committee on Equalization of Voting Power stated that an inequality of voting power does exist and recommended that the committee be given further time in which to offer a solution to the problem.

The Nominating Committee's report met with no opposition, the following officers being elected: President, George T. Adee, New York; vice-president, Julian S. Myrick, New York; secretary, Edwin F. Torrey, Clinton, N. Y.; treasurer, Alfred H. Chapin, Boston, Mass.

After a session of three hours the meeting adjourned to the banquet hall, where the Victory Dinner was celebrated with great enthusiasm and good-fellowship.



**ALFRED H. CHAPIN,**  
Springfield, Mass.  
Treasurer United States National Lawn Tennis Association

## Officers

### President

GEORGE T. ADEE  
62 Broadway, New York City  
Telephone, Rector 5823

### Vice-President

JULIAN S. MYRICK  
38 Nassau St., New York City  
Telephone, John 3662

### Secretary

EDWIN F. TORREY  
P. O. Box 146, Clinton, N. Y.  
Telephone, Clinton 9M

### Treasurer

ALFRED H. CHAPIN  
336 Birnie Ave., Springfield, Mass.  
Telephone, River 4735

### Executive Committee

The above Officers and Sectional Delegates

(Serving until Annual Meeting of 1920)

J. B. ADOUE, JR., c/o National Bank of Commerce, Dallas, Tex. SOUTHWESTERN  
W. C. BURTON, c/o Plymouth Clothing Co., Minneapolis, Minn. NORTHWESTERN  
DR. SUMNER HARDY, 209 Post St., San Francisco, Cal. . . . . CALIFORNIA  
R. W. HOLTERHOFF, 918 Union Trust Bldg., Cincinnati, Ohio. . . . . TRI-STATE  
EDWIN SHEAFE, 141 Milk St., Boston, Mass. . . . . NEW ENGLAND

(Serving until Annual Meeting of 1921)

WALTER A. GOSS, 413 Corbett Bldg., Portland, Ore. . . . . PACIFIC NORTHWEST  
JOSEPH M. JENNINGS, 612 Germantown Ave., Chestnut Hill, Pa. MIDDLE STATES  
A. Y. LEECH, JR., 719 Fifteenth St., N.W., Washington, D. C. MIDDLE ATLANTIC  
O. J. SALISBURY, 208 Felt Bldg., Salt Lake City, Utah. . . . . INTER-MOUNTAIN  
CARLETON Y. SMITH, 608 Walton Bldg., Atlanta, Ga. . . . . SOUTHERN  
L. H. WADNER, 175 West Jackson Blvd., Chicago, Ill. . . . . WESTERN

### Delegates-at-Large

(Serving until Annual Meeting of 1920)

CLINTON L. CHILDS. . . . . Union Bank Bldg., Pittsburgh, Pa.  
C. DRUMMOND JONES. . . . . Busch-Diesel Co., St. Louis, Mo.  
PAUL SHELDON. . . . . P. O. Box 184, Hartford, Conn.

(Serving until Annual Meeting of 1921)

CRAIG BIDDLE. . . . . 112 Drexel Bldg., Philadelphia, Pa.  
W. J. CLOTHIER. . . . . 133 South 4th St., Philadelphia, Pa.  
WATSON M. WASHBURN. . . . . 52 E. 79th St., New York City  
R. NORRIS WILLIAMS, 2d. . . . . 90 Lake Ave., Newton Centre, Boston, Mass.

### Field Secretary

PAUL B. WILLIAMS. . . . . 20 Broad St., New York City  
Telephone, Rector 3547

### Former Presidents

JOSEPH S. CLARK. . . . . 321 Chestnut St., Philadelphia, Pa.  
HARRY W. SLOCUM. . . . . 332 Lexington Ave., New York City  
ROBERT D. WRENN. . . . . 24 Broad St., New York City



PAUL B. WILLIAMS,  
20 Broad Street, New York City.  
Field Secretary United States National Lawn Tennis Association.

## Committees for 1919

Note—The person first named is in each instance the committee chairman.

**BALL COMMITTEE**—G. A. L. Dionne, Harry C. Johnson, Walter M. Hall, Henry C. Martin, Philip B. Hawk, Charles Garland, J. C. Stewart, J. C. Rohlf.

**COMMITTEE ON CODIFICATION OF LAWS OF LAWN TENNIS AND CASES AND DECISIONS**—S. Wallis Merrihew, R. N. Williams, 2d, Beals C. Wright, Abraham Bassford, Jr., E. C. Conlin, Samuel Hardy.

**DAVIS CUP COMMITTEE**—Robert D. Wrenn, George T. Adee, Harry W. Slocum, Julian S. Myrick.

**COMMITTEE ON DEVELOPMENT OF BOYS' JUNIOR AND GIRLS' TENNIS**—Charles Garland, Edwin F. Torrey, Richard Stevens, Paul W. Gibbons, Edwin Sheafe, L. H. Waidner, Louis I. Doyle, J. D. E. Jones, Dr. S. R. Marvin, Fred B. Alexander, George O. Wagner.

**COMMITTEE ON DEVELOPMENT OF MUNICIPAL TENNIS**—George W. Wightman, Dwight F. Davis, Dr. Sumner Hardy, C. Drummond Jones, R. L. Van Arsdale, J. E. McLain, A. L. Hoskins, Wm. Alex. Campbell, A. Y. Leech, Jr., Carleton Y. Smith, Ward C. Burton, Walter A. Goss, Simpson Sinsabaugh, J. B. Adoue, Jr., Arthur J. Larmon, Edwin F. Torrey, Julian S. Myrick, E. R. Saal, Paul B. Williams.

**NATIONAL DOUBLES CHAMPIONSHIP COMMITTEE**—Edwin F. Torrey, Edwin Sheafe, L. H. Waidner, George T. Adee.

**FINANCE COMMITTEE**—George T. Adee, Julian S. Myrick.

**INVESTMENT COMMITTEE**—Alfred H. Chapin, Palmer E. Presbrey, Howard W. Lewis.

**NATIONAL SINGLES CHAMPIONSHIP COMMITTEE**—George T. Adee, Edwin F. Torrey, C. Frederick Watson, Jr.

**NATIONAL UMPIRES' ASSOCIATION COMMITTEE**—Edward C. Conlin, O. L. Becker, R. D. Little, Harold Swain, Fred G. Anderson, Christopher B. Winne, George E. Jamison, Fred B. Alexander, Frederick P. Adams, Richard Bishop, Paul W. Gibbons, B. M. Grant, J. E. McLain, Davison Obear, Thomas C. Bundy.

**RANKING COMMITTEE**—Abraham Bassford, Jr., Paul W. Gibbons, Conrad B. Doyle, Walter T. Hayes, Harry C. Johnson, Paul B. Williams.

**SCHEDULE COMMITTEE**—S. Wallis Merrihew, Paul B. Williams.

**WOMEN'S NATIONAL CHAMPIONSHIP COMMITTEE**—Craig Biddle, A. L. Hoskins.

**COMMITTEE ON EQUALIZATION OF VOTING POWER**—A. Y. Leech, Jr., L. H. Waidner, Dr. Sumner Hardy, Julian S. Myrick, Edwin Sheafe, Charles Garland.

**WOMEN'S ADVISORY COMMITTEE**—Mrs. George W. Wightman, Miss Florence Balhn, Mrs. Clement R. Wainwright, Miss Carrie B. Neely, Miss Anita Myers.

**AMATEUR RULE**—George T. Adee, Julian S. Myrick, Edwin Sheafe, Dr. Sumner Hardy, Joseph M. Jennings, George W. Wightman, Robert D. Wrenn, Edwin F. Torrey.

# Constitution

## ARTICLE I.

### NAME.

This organization shall be known as the "UNITED STATES NATIONAL LAWN TENNIS ASSOCIATION," hereinafter referred to as the National Association.

## ARTICLE II.

### MEMBERS.

SECTION 1. The membership shall consist of the following classes:

- (1) Clubs.
- (2) Active Associations.
- (3) Allied Associations.
- (4) Park Associations.

Allied associations shall consist of associations of schools or colleges, but such associations, if they so desire, may become active associations by notifying the Secretary of the National Association and paying the dues for an active association. Active associations shall consist of all associations other than allied and park associations and in each case the limits of an active association shall necessarily exclude to that extent the limits of every other association. Park associations shall consist of associations of parks, not more than one association from any one city, and approved by the park commissioner.

SEC. 2. An association, either (2) or (3), shall consist of five or more individual clubs, any one of which may or may not be itself a member directly of the National Association. Each club shall at all meetings be entitled to one vote. Each active association shall be entitled to two votes and to one additional vote for every five clubs or fraction thereof members of it over ten. Allied and park associations shall not be entitled to any vote. No club being itself a member of the National Association shall be counted as a member of an active association in determining the number of votes which may be cast by such association. No member of the National Association in arrears or failing to have paid its fiscal dues by the first of February each year preceding the annual meeting, shall be entitled to vote at such meeting, nor shall such club be awarded an officially sanctioned tournament held under the auspices of the United States National Lawn Tennis Association.

SEC. 3. On or before the first day of January in each year, each sub-association shall send to the Secretary of the National Association the names and addresses of its secretary and treasurer and a list of the clubs belonging to it on December 1st preceding (with the name and address of each club's secretary), and each club directly a member of the National Association shall send to the Secretary of the National Association the names and addresses of its secretary and treasurer, holding office on December 1st preceding. The secretary of each association shall notify the Secretary of the National Association of any changes in its membership immediately upon their occurrence.

## ARTICLE III.

### ELECTION OF MEMBERS.

SECTION 1. Proposals for membership must be made in writing to the Executive Committee, hereinafter provided for, with the name and address

of the applicant, and signed by the proper officer of the club or association making the proposal, and shall give such information with regard to membership, grounds, etc., as shall be required by the Executive Committee. Where the applicant is an association, the names and addresses of each of its members shall be given with the application, together with a statement of the limits that it desires to represent.

SEC. 2. The Executive Committee shall have full power to elect candidates for membership, except that no association shall be deemed a member whose limits shall conflict with those of any other association until its election be confirmed by a two-thirds vote at the annual meeting of the National Association, or the associations upon whose limits it encroaches consent to such encroachment. The election to membership of such an association automatically decreases the limits of other associations to such an extent as shall preclude a conflict of limits.

SEC. 3. *Dues, etc.*—The annual dues to the National Association in the case of clubs shall be ten dollars (\$10) and in the case of active associations shall be thirty-five dollars (\$35), except that where any such association is composed of more than ten clubs its annual dues shall in addition be fifteen dollars (\$15) for every five clubs or fraction thereof above ten. Allied and park associations shall not be required to pay any annual dues. No club or association shall be allowed the privilege of a member until after its first annual dues have been paid and no club shall be entitled to a vote at the annual meeting of the National Association unless it was a member thereof for the preceding fiscal year. The fiscal year of the National Association shall begin February 1st. All dues for the ensuing year are payable on or before May 1st.

SEC. 4. *Limits of Payments, etc.*—Any club or association which shall fail to have paid its annual dues on or before June 1st may be debarred from the privileges of a member by the Executive Committee until the same are paid, and, at their discretion, may be dropped from the roll.

## ARTICLE IV.

### RESIGNATIONS, EXPULSIONS, ETC.

SECTION 1. *Resignations, etc.*—Any member wishing to resign must do so in writing, addressed to the Secretary; and the resignation cannot be accepted until all dues for the current fiscal year are paid. Resignations must be received before February 1st to relieve the member from payment of dues for the ensuing year.

SEC. 2. The Executive Committee of the National Association, hereinafter provided for, shall have the power to suspend or expel any member which may neglect or refuse a strict and honorable compliance with its Constitution, By-Laws, etc., or which shall, by its conduct, bring reproach or disgrace upon the National Association; or which shall, being itself an association, retain as one of its members any club objected to by notice in writing by the Executive Committee, subject to the right of any member, if expelled, to appeal to the National Association, at its next annual meeting, for reinstatement.

## ARTICLE V.

### OFFICERS.

SECTION 1. The affairs of the National Association shall be conducted by an Executive Committee composed of the President, Vice-President, Secretary, Treasurer, and such Ex-Presidents of the Association as may be elected from year to year at the annual meeting, and seventeen other members, eleven of whom shall represent stated sections of the country as provided in Section 2 of this article, and shall be called Sectional Delegates. The remaining six shall be called Delegates-at-large.

SEC. 2. The stated sections of the country hereinbefore referred to shall be as follows:

- New England, comprising the states of  
 Connecticut, Massachusetts, Rhode Island,  
 Maine, New Hampshire, Vermont.
- Middle States, comprising the states of  
 New Jersey, New York, Pennsylvania.
- Middle Atlantic, comprising the states of  
 Delaware, Virginia,  
 Maryland, West Virginia,  
 and the District of Columbia.
- Tri-State, comprising the states of  
 Indiana, Kentucky, Ohio.
- Southern, comprising the states of  
 Alabama, Louisiana, South Carolina,  
 Florida, Mississippi, Tennessee,  
 Georgia, North Carolina,
- Western, comprising the states of  
 Illinois, Michigan, Nebraska,  
 Iowa, Missouri, Wisconsin,  
 Kansas,
- Northwestern, comprising the states of  
 Minnesota, North Dakota,  
 Montana, South Dakota.
- Southwestern, comprising the states of  
 Arizona, New Mexico, Oklahoma,  
 Arkansas, Texas.
- Inter-Mountain, comprising the states of  
 Colorado, Nevada, Utah,  
 Idaho (south of the 45th parallel of latitude), Wyoming.
- Pacific Northwest, comprising the states of  
 Idaho (north of the 45th parallel of latitude), Oregon,  
 Washington.
- California, comprising the state of California.

SEC. 3. The President, Vice-President, Secretary and Treasurer shall be elected at the annual meeting of the National Association in each year and shall serve until their respective successors are elected. The Sectional Delegates shall be appointed by the active associations of the sections which they respectively represent and shall serve for two years. If a section is not represented by an active association its delegate shall be elected by the National Association at its annual meeting. Each Sectional Delegate must live in the section which he represents. On his removal outside the bounds of such section his place shall become vacant. Sectional Delegates appointed by active associations must present their certificates of appointment to the Secretary of the National Association at or before the annual meeting.

SEC. 4. The Sectional Delegates shall serve for two years, and as the term of each delegate expires his association shall appoint, or the National Association shall elect his successor. The Delegates-at-large shall



serve for two years and shall be elected three each year at the annual meeting of the National Association. The election of officers and delegates shall be by ballot and a majority vote shall be required to elect. Any vacancy among the officers or members of the Executive Committee may be filled by the Executive Committee. Such appointee shall hold office only until the next annual meeting, when a successor shall be elected or appointed as provided in Section 3.

SEC. 5. *The President.*—It shall be the duty of the President to preside at all meetings of the Executive Committee and of the National Association; to preserve order, to appoint all committees not otherwise provided for, and to see that the officers and committees perform their respective duties.

SEC. 6. *The Vice-President.*—The Vice-President shall assist the President in the performance of his duties, and shall exercise all the powers of the President in his absence.

SEC. 7. *The Secretary.*—The Secretary shall keep a roll of all the members, and from time to time amend and correct the same as circumstances require. He shall notify new members of their election within two weeks thereafter, and shall give notice of all meetings of the Executive Committee at least two weeks in advance. He shall conduct all the correspondence of the National Association, and keep copies of all letters in a book provided for that purpose. He shall keep the minutes of the proceedings of the National Association and Executive Committee and a record of such matters of interest as may occur, and may employ such clerical assistance as may be authorized by the Executive Committee.

SEC. 8. *The Treasurer.*—The Treasurer shall keep, in a suitable book provided for that purpose, an account of all moneys received and paid. He shall liquidate all properly authorized bills against the National Association, and shall report in writing the state of the finances when required by the Executive Committee; and, at the annual meeting, he shall present a written report showing all the receipts and expenditures for the year. His account shall be audited by an Audit Company at least once annually, and he may employ such clerical assistance as may be authorized by the Executive Committee.

SEC. 9. *The Executive Committee, etc.*—It shall be the duty of the Executive Committee to see that the general provisions of the Constitution and By-laws of the National Association are complied with by members of the same; to hear and decide all questions submitted by members for decision, at least one week's notice of hearing being given to any other member who may be affected by the question; to construe and enforce all the rules of the National Association. All decisions of the Executive Committee shall be complied with forthwith; but an appeal therefrom may be taken by any member to the National Association at its next annual meeting. The Executive Committee and the Secretary shall cause official notices, and such other matters of information as they shall deem of interest, to be published in a paper which may be appointed annually by the Executive Committee as the official bulletin of the National Association. All members are to be given notice of said appointment, and thereafter are expected to take notice of official publications therein. The Executive Committee shall have the supervision over all tournaments conducted under the auspices of the National Association, and may assume the conduct of such tournaments as it shall deem advisable. It shall have general charge of the funds of the National Association and shall control all expenditures. It may charge off all bills owing to the National Association which it shall deem uncollectible.

Each member of the Executive Committee must be a member of a club belonging either directly to the National Association, or indirectly as specified in Art. II, Sec. 2. Seven members, including officers, shall constitute a quorum at any meeting of the Executive Committee.

SEC. 10. *The Nominating Committee.*—A Nominating Committee of not less than three nor more than five members (none of whom shall be a member of the Executive Committee) shall be elected at the annual meeting and notice of such election shall be sent immediately to all members of the Association by the Secretary. The Nominating Committee shall make nominations for the officers and members of the Executive Committee and members of the Nominating Committee, to be voted on at the ensuing annual meeting under the provisions of this Constitution. A notice containing such nominations shall be sent to every member of the Association by the Secretary, together with the notice of the annual meeting. Only one member of the Nominating Committee may serve continuously for two years.

SEC. 11. *Sectional Delegates.*—In addition to their other duties as members of the Executive Committee it shall be the duty of Sectional Delegates to carefully observe conditions relating to the game in the sections which they respectively represent and to report thereon to the officers of the National Association and the Executive Committee.

## ARTICLE VI.

### MEETINGS.

SECTION 1. There shall be a stated annual meeting of the National Association held, on a date to be fixed by the President, between the 1st and 15th of February, in each year, at a place to be designated at the previous annual meeting, or, in the absence of such designation, by the President. At least thirty and not more than sixty days before such meeting a written notice thereof shall be mailed to each member of the National Association by the Secretary.

SEC. 2. A special meeting of the National Association may be called by the Executive Committee at any time, and shall be so called upon the written request of at least fifteen members thereof. At least twenty days before such meeting a written notice thereof shall be mailed to each member of the National Association by the Secretary, stating the object of the meeting. Only those matters specified in such notice shall be considered at the meeting.

SEC. 3. At all meetings of the National Association the representatives of twenty-five members shall constitute a quorum.

SEC. 4. At all meetings members may be represented by a delegate belonging to such member, if a club, or to a club belonging to such member of an association, or by proxy. Each person holding a proxy must be a member of some club belonging to the National Association, or to an association which belongs to the National Association. Each delegate or proxy must present at the meeting written credentials from the member he represents, signed and attested by at least two officers, one of whom may be chairman of the committee in charge of tennis affairs.

## ARTICLE VII.

### AMENDMENTS, ETC.

Amendments to this Constitution may be made at any annual meeting by a vote of at least two-thirds of all the votes cast, provided that at least thirty days before such meeting a notice of the proposed amendment be sent to each club or association in the National Association. By-laws may be amended at any annual or special meeting under the same provisions.

## By-Laws

---

### ARTICLE I.

#### ORDER OF BUSINESS, ETC.

**SECTION 1.** The order of business for this Association shall be as follows:—

1. Roll Call.
2. Reading of Minutes.
3. Secretary's Report
4. Treasurer's Report.
5. Reports of Committees.
6. Elections.
7. Miscellaneous Business.
8. Adjournment.

**SEC. 2.** *Authority for Rules of Order.*—For the "Rules of Order," and any and all parliamentary rules not herein mentioned, those laid down in "Cushing's Manual" shall be authority.

### ARTICLE II.

**SECTION 1.** All clubs represented in this Association shall be governed by the laws of Lawn Tennis as laid down by this Association.

**SEC. 2.** *Laws of Matches, etc.*—All matches played by clubs represented in this Association shall be played under all the rules adopted by it.

**SEC. 3.** None but amateurs shall be allowed to enter for any match or matches played under the auspices of this Association.

**SEC. 4.** An amateur tennis player is one who plays tennis solely for the pleasure and physical benefits he derives therefrom, and to whom the playing of tennis is nothing more than a pastime.

**SEC. 5.** *Acts of Disbarment.*—A person shall cease to be an amateur by committing any of the following acts:

1. By entering a competition open only to professionals, or playing for a money prize or gate receipts.
2. By playing, instructing, pursuing or assisting in the pursuit of tennis or other athletic exercise as a means of livelihood or for gain or any emolument.
3. By obtaining or retaining membership in any tennis or athletic club of any kind because of any mutual understanding, express or implied, whereby such membership would be of any pecuniary benefit to the member or the club.
4. By permitting or sanctioning the use of his name to advertise or promote the sale of tennis goods for pecuniary profit, or by permitting his name to be advertised or published as the author of books or articles on tennis of which he is not actually the author.
5. By selling, pledging or otherwise converting into money any prize won in a tennis tournament or converting any prize so won into any article or articles, commonly known as necessities, such as food, ordinary clothing, etc., or accepting as a prize any such article.

6. By playing in a team or exhibition match where gate receipts are charged, unless permission to hold such match shall have been previously obtained from the Executive Committee, or from a sub-committee appointed by the Executive Committee, or from the Sectional Delegate of the section in which such match is to be played.
7. By being connected with the sale of tennis goods, or with a firm manufacturing or selling tennis goods, except when such connection shall be of a general nature in a firm manufacturing or selling general athletic goods, and the person so connected has to do with tennis goods to no greater extent than with any other line of goods.
8. By being guilty of grossly unsportsmanlike conduct.

SEC. 6. 1. The Executive Committee of the United States National Lawn Tennis Association shall be the tribunal to decide whether a player has violated any provisions of Sections 4 or 5 of these by-laws.

2. Any person who becomes ineligible by reason of by-laws 4 or 5 may be reinstated on giving to the Executive Committee of the United States National Lawn Tennis Association satisfactory evidence of meriting such reinstatement.

*Note.*—*The Association earnestly recommends that clubs use due vigilance to see that their own members observe Sections 4 and 5 and to report any violations, with full particulars relating to each case, to the Executive Committee.*

SEC. 7. No player shall be allowed to enter for any match given by this Association unless he is a member of a club belonging either directly to this Association, or indirectly through an Active or Allied Association (Class 2 or 3), as specified in Article II, Section 1, of the Constitution, or is the winner of a member Park Association (Class 4) final championship tournament, or has played in an interscholastic tournament of the same year. But the Executive Committee is empowered, at its discretion, to permit, for special cause, any foreigners or other players to enter for any match given under the auspices of this Association.

### ARTICLE III.

#### SUSPENSION OF BY-LAWS.

Any article or section of these By-laws may be suspended for any one meeting by a two-thirds vote of all cast.

## QUALIFICATIONS FOR ENTRY IN THE NATIONAL SINGLES CHAMPIONSHIP

(Adopted by the Annual Meeting of the U.S.N.L.T.A., Feb. 9, 1917.)

Entries shall close on a published date at least ten days prior to the beginning of play.

Entry shall be open to players in good standing belonging to clubs or associations having membership in the United States National Lawn Tennis Association, as follows:

1. Players who have been ranked by the U.S.N.L.T.A. during any of the five years last preceding the tournament, or who have at any time been ranked in the first twenty.
2. Players who, in the last three years preceding the championship, have been semi-finalists or better in any two tournaments sanctioned by the U.S.N.L.T.A.
3. Players who have in the current playing season played in not less than three sanctioned tournaments, and have made a reasonably good record. The committee of management of the tournament to have the power to rule on the value of a player's record.
4. Players who do not qualify in any of the above classes but whose entry is acceptable to the Executive Committee of the U.S.N.L.T.A. by reason of residence in foreign countries, promise of skill or other circumstances deemed sufficient to cause exceptions in their cases.
5. All entries shall be made through the club secretary.

## NATIONAL DOUBLES CHAMPIONSHIP

At the annual meeting of the United States National Lawn Tennis Association, February 7, 1919, the delegates voted to hold the national doubles championship at the Longwood Cricket Club, under the following rules:

1. To be eligible for competition in the national doubles championship, a team must first have won a current sectional doubles championship.
2. Each member of a sectional doubles team must be a member in good standing of a club in good standing, belonging directly or indirectly to the U.S.N.L.T.A. Any team or player who has won a sectional doubles championship is ineligible for play in other current sectional doubles championships.
3. The place for holding the national doubles championship shall be decided at the annual meeting. Each duly accredited section shall be entitled to a doubles championship.
4. In the national doubles championship the teams shall be bracketed by the usual draw. The winning team shall have the right to challenge the champions, and the challenge round shall be a part of this tournament. The winners of the challenge round shall become the national doubles champions.

## REGULATIONS GOVERNING JUNIOR, BOYS' AND GIRLS' TOURNAMENTS, 1919

**THE PLAN OF COMPETITION:** Competition for the national junior, national boys' and national girls' championships of the United States is planned on a series of elimination contests. These shall begin with preliminary tournaments whose winners only shall be eligible to compete for district championships in cities designated by the United States National Lawn Tennis Association as tennis centers. Winners of these tennis center events shall be eligible to compete for the national titles, the same plan applying to juniors, boys and girls, in both singles and doubles.

**TOURNAMENTS:** Any club, college or park association, member directly or indirectly of the U.S.N.L.T.A., may give preliminary sanctioned tournaments.

No dues are required by the U.S.N.L.T.A. other than the regular dues (if any) of the organization giving the event.

Sanction must be obtained in the usual manner by application to the Field Secretary, Paul B. Williams, 20 Broad Street, New York City.

The national interscholastic championship has been discontinued, but interscholastic tournaments may, like junior tournaments, be given preliminary to tennis center tournaments.

**ELIGIBILITY:** Junior tournaments shall be open to boys who have not reached their eighteenth birthday on March 1 in the year of competition. Girls' tournaments are governed by the same age requirements as junior events.

Interscholastic tournaments shall be open to boys complying with this age limit and who are also attending schools preparing for college. Winners of interscholastic tournaments shall be eligible to compete in any one junior tennis center championship.

Boys' tournaments shall be open to boys who have not reached their fifteenth birthday on March 1 in the year of competition.

The winner of a preliminary tournament shall be eligible to compete in any one tennis center championship tournament.

A boy winning both a junior or interscholastic and a boys' preliminary tournament may compete in a tennis center championship in either class, but in one only.

There shall be no limit as to the number of preliminary tournaments a player may enter.

In case the winner of a singles tournament is unable to compete in the event to which he thus becomes eligible, the management of such tournament may nominate another participant.

In case a team winning a doubles tournament is unable to compete in the event to which it thus becomes eligible, the management of such tournament may nominate another team which participated in the tournament.

Winners of tennis center championships shall be eligible to compete, in their respective classes, for the national junior, national boys' or national girls' championship, in tournaments to be held at the same time and place as the national singles championship.

The following cities have been designated as tennis centers:

**CALIFORNIA:** San Francisco, Los Angeles, Fresno.

**INTER-MOUNTAIN:** Salt Lake City, Denver.

**MIDDLE ATLANTIC:** Baltimore, Washington, Charleston (W. Va.), Richmond.

**MIDDLE STATES:** New York, Brooklyn, Montclair, Utica, Buffalo, Pittsburgh, Philadelphia.

**NEW ENGLAND:** Portland, Me.; Boston, Providence, Hartford.

**NORTHWESTERN:** Duluth, Minneapolis, Grand Forks (N. D.), Sioux Falls (S. D.), Butte (Mont.), Faribault (Minn.).

**PACIFIC NORTHWEST:** Tacoma, Seattle, Spokane (Wash.), Portland (Ore.), Lewiston (Idaho).

**SOUTHERN:** Knoxville, Memphis, Birmingham, Atlanta, New Orleans, Greenville (S. C.), Charlotte (N. C.), Asheville (N. C.), Chattanooga (Tenn.), Nashville (Tenn.).

**SOUTHWESTERN:** Oklahoma City, Little Rock (Ark.), Austin, Houston, Dallas, El Paso, Tucson (Ariz.).

**TRI-STATE:** Cleveland, Indianapolis, Cincinnati, Louisville (Ky.), Toledo

**WESTERN:** Milwaukee, Grand Rapids, Detroit, Chicago, Springfield (Ill.), Dubuque, Des Moines, Sioux City, Omaha, Kansas City, Wichita, St Louis.

The Executive Committee may, in their discretion, add to the number of tennis centers.

## NATIONAL UMPIRES' ASSOCIATION

Organization of the National Umpires' Association was undertaken after the annual meeting of the United States National Lawn Tennis Association in 1917, but little was accomplished because of the war. Interest in the project continued, however, and the committee was instructed by the annual meeting of 1919 to proceed with the development of its plans.

In each tennis center a local chapter of the National Umpires' Association is being formed under the supervision of a chairman appointed by the national body. It is planned thus to make the membership thoroughly national in scope and policy. The effect will be to raise the standards of tournament play throughout the country by securing widespread knowledge and uniform application of the rules.

A handbook for tournament officials is being prepared by the chairman, Edward C. Conlin. Correspondence should be addressed to the National Umpires' Association, Room 721, 20 Broad Street, New York City.

## RULES FOR RANKING

On or before April 1 in each year the Executive Committee shall appoint a committee composed of five men to be known as the Ranking Committee. It shall be the duty of the Ranking Committee to make the rankings for the ensuing season of play under and pursuant to the following rules to be known as

### RULES FOR THE RANKING OF PLAYERS

(1) The results of all events sanctioned by the United States National Lawn Tennis Association occurring within the period of the playing season under consideration, including international and team matches, irrespective of whether the competitions took place in this country or abroad, shall be considered in the rankings.

(2) All returns, made pursuant to Rules 24 and 25 of Regulations for the Management of Lawn Tennis Tournaments, shall be filed with the Ranking Committee at the office of the Field Secretary of the U.S.N.L.T.A.

(3) The Field Secretary shall keep a separate card index for each season's play, in which there shall be recorded all competitors in men's and women's singles and men's doubles played during that season in the events named in Rule 1 hereof. There shall be a separate card for each singles player and for each doubles team. The full names and post office addresses of all players shall appear on their respective cards. When the card of an individual or team shows participation in three sanctioned tournaments, the detailed summary of matches of the individual or team shall be transferred from the tournament reports to a record card, for consideration by the Ranking Committee.

(4) Each year there shall be six rankings, as follows:

1. Men's singles, in which at least 100 individuals shall be named.
2. Men's doubles, in which at least 20 teams shall be named.
3. Women's singles, in which at least 30 individuals shall be named.
4. Junior singles, in which at least 50 individuals shall be named.
5. Boys' singles, in which at least 50 individuals shall be named.
6. Girls' singles, in which at least 20 individuals shall be named.

In each case the individuals or teams shall be divided into classes. There may be one or more individuals or teams placed in any class. The player or players with the best season's records shall be placed in Class 1; the player or players with the next best records shall be placed in Class 2; and so on, for any number of classes, according to the decision of the Ranking Committee. In addition, the players or teams shall be ranked numerically.

(5) To be considered for a ranking, an individual or team must participate during the season in at least three sanctioned events; but on the unanimous vote of the Ranking Committee, occasional exceptions to this rule may be made. An individual or team, however, need not necessarily be ranked because of having qualified under this rule, if in the opinion of a majority of the committee the data furnished by the record in question is insufficient for the purpose or the standard of play does not warrant any ranking.

(6) The rankings shall be based solely upon the records of the players for the season under consideration and not upon the opinion of the Ranking Committee. Middle and late season performance shall be given greater consideration than that of the early season.

(7) Any individual or team may be ranked irrespective of nationality or place of residence.

(8) The winners of national championships shall be ranked on their season's records as are other players and shall not be arbitrarily placed at the

head of the rankings, but in a comparison of their records with those of other players, they shall be given the benefit of any reasonable doubt as to the relative merits of such records.

(9) The Ranking Committee shall submit its report to the Executive Committee at the meeting of the Executive Committee held in December of the year for which the rankings are made. The Executive Committee may alter the rankings as submitted.

(10) Members of the Ranking Committee shall not divulge any of the results of their deliberations or any other information concerning the rankings prior to the publication thereof by the Executive Committee.

(11) The Ranking Committee's report shall be published in the official organ of the U.S.N.L.T.A. in the first issue thereof following the meeting of the Executive Committee at which the report is submitted.

(12) The rankings shall be made by computing the ratings and relative positions of the players or teams by the law of averages based on the following system:

### RULES TO DETERMINE PLAYERS' RATING

1. The players to be considered are first placed in their approximate class; i. e., 0-10, 10-20, to 90-100.

2. Using the approximate class list and rating tables (appended), rating for each representative match should be computed. However, in no case shall the computed difference in rate for any match exceed by 20 points the difference shown in the established approximate class or prime rate. This rule is made to prevent one match which is an absolute reversal of form from ruining a player's season-record. (Application: Player H (0) defeats Player S (10), 6/2,6/0,6/0. For this match, therefore, H's rating is minus 40 and S's rating is plus 50. But under Rule 2 the difference cannot be more than 20 points plus the difference between the approximate class ratings, which in this case is 10. Therefore the computed difference in rating is 30 and the ratings are: H, minus 20; S, plus 30.)

3. The average (or prime) rating for each tournament is computed by averaging the rates obtained in the several matches played.

4. The year's prime rate is computed by averaging the player's tournament ratings, using the weight established for each tournament.

5. The weight given tournament ratings in the general average is to be as follows:

|                              |   |
|------------------------------|---|
| National championship .....  | 4 |
| Clay court championship..... | 3 |
| Sectional championship ..... | 2 |
| Other tournaments .....      | 1 |

(Note—In addition to the championships of sections as designated by the constitution of the U.S.N.L.T.A., the following events shall have the weight of "sectional" championships: Seabright, Southampton, Rockaway, Newport, Philadelphia and District, Western Pennsylvania, Central States.)

6. Final rating is established by using the aforementioned methods together with the prime rating instead of the approximate class as a basis for estimating.

### NOTES.

A. The approximate class is generally determined from previous ranking lists and knowledge of a player's ability.

B. The prime rate ordinarily will be sufficient to determine a player's rank. However, when two players are very evenly matched, their relative standing must be determined by a second rating as explained in Rule 6.

### RATING TABLE.

#### Best in 3-set matches.

- 5 Class—Win one set and total games equal opponent's, less 2.
- 10 Class—Win one set, or total games equal 10.
- 20 Class—Win 8 games.
- 30 Class—Win 6 games.
- 40 Class—Win 4 games.
- 50 Class—Win 2 games.

#### Best in 5-set matches.

- 5 Class—Win one set and total games equal opponent's, less 4.
- 10 Class—Win 15 games.
- 20 Class—Win 12 games.
- 30 Class—Win 9 games.
- 40 Class—Win 6 games.
- 50 Class—Win 3 games.



## EXAMPLE.

Suppose there are only four players—A, B, C and D—entered in a tournament. They are assumed to have the following approximate classification (see Rule 1):

- A is a player whose class is known to be about 40.
- B is a player whose class is known to be about 30.
- C is a player whose class is known to be about 20.
- D is a player whose class is known to be about 10.

D defeats A, 6/2,6/2; therefore his rate is.....40 minus 40 = 0  
 D defeats C, 6/4,4/6,6/4; therefore his rate is...20 minus 5 = 15  
 2)15

Therefore the tournament average or prime rate for D is..... 7.5

The above figures are obtained for the winner (D is winner) by subtracting from his opponent's approximate class (A is class 40) the value set in the rating table for the games won by the opponent (A won four games in a 3-set match, for which the rating is —40), hence the 40 minus 40 = 0. For the loser the same process is followed except that the figures are added instead of subtracted.)

A loses to D, 2/6,2/6; therefore A's rate is.....10 plus 40 = 50  
 C defeats B, 7/5,7/5; therefore his rate is.....30 minus 10 = 20  
 C loses to D, 4/6,6/4,4/6; therefore his rate is....10 plus 5 = 15  
 2)35

Therefore the tournament average or prime rate for C is.... 17.5

B loses to C, 7/5,7/5; therefore B's rate is.....20 plus 10 = 30

## PRIME RATING.

To compute a player's rating for the season, it is necessary to consider not only his rating in any given tournament, but also the weight of the tournament (see Rule 5). The national championship has a weight of 4, clay court 3, sectional championships 2, other tournaments 1. Now if a player had a rate of 30 in the national, 20 in the clay court, 25 in a sectional, 10 in one other tournament and 15 in another, his prime rating would be obtained by averaging his rating in each event, multiplied by the weight of the tournament, as follows:

National championship rate.....30 times 4 (weight) = 120 or 30  
 Clay court championship rate....20 times 3 (weight) = 60 or 20  
 Sectional championship rate.....25 times 2 (weight) = 50 or 25  
 Other event rate.....10 times 1 (weight) = 10 or 10  
 Other event rate.....15 times 1 (weight) = 15 or 15  
 11)255.00

The player's prime rating for the season is..... 23.18

This figure generally determines the player's position on the ranking list. If two men are very close, their records may be re-figured, using the prime rate established above, instead of the approximate class, and the result thus obtained will be the final rating.

(13) These rules may be amended and additions thereto may be made by the Executive Committee at any of its meetings.

## APPLICATIONS FOR TOURNAMENTS

Applications for officially sanctioned tournaments for 1920 must be made to Paul B. Williams, Field Secretary, 20 Broad Street, New York City, on or before March 8, 1920.

Any club failing to apply in writing before that date will not be awarded the tournament applied for.

By order of the Executive Committee,

EDWIN FULLER TORREY,

Secretary.

## COLLEGES ENDORSE TENNIS

The following resolution was adopted by the National Collegiate Athletic Association at its meeting in New York on December 27, 1918:

WHEREAS, The aim of intercollegiate athletics is to promote the welfare of undergraduates by providing competition in sports which develop the player mentally and morally, as well as physically; and

WHEREAS, Those sports which can be played without elaborate equipment and training are best adapted to the needs of the majority of undergraduates; and

WHEREAS, Tennis develops an alert mentality and high standards of sportsmanship, provides vigorous exercise and is a game that can be played throughout life; now, therefore, be it

RESOLVED, That the National Collegiate Athletic Association recommend to its members

- (1) That they provide sufficient tennis courts to accommodate the requirements of the student body.
- (2) That they accord recognition to the tennis team equivalent to that given the institution's representatives in other lines of sport.

## AMATEUR RULE

The attention of members of the United States National Lawn Tennis Association is called to the following resolution adopted by the Executive Committee of the U.S.N.L.T.A., at its annual meeting in New York City, March 21, 1919:

WHEREAS, The annual meeting of the U.S.N.L.T.A., held in New York, February 9, 1917, adopted as Section 5, Sub-Section 2 of the By-Laws, the following rule:

"A person shall cease to be an amateur—by playing, instructing, pursuing, or assisting in the pursuit of, tennis or other athletic exercises as a means of livelihood, or for gain or for any emolument";

RESOLVED, That any club or association directly or indirectly paying the expenses, board or lodging of any tennis player must send a detailed memorandum of such expenses to E. F. Torrey, Secretary, P. O. Box 146, Clinton, N. Y., for the information of the Executive Committee, or further sanction may be refused.

WHEREAS, The annual meeting of the U.S.N.L.T.A., held in New York, February 9, 1917, adopted as Section 5, Sub-Section 7, the following rule:

"A person shall cease to be an amateur—by being connected with the sale of tennis goods, or with a firm manufacturing or selling tennis goods, except as such connection shall be of a general nature in a firm manufacturing or selling general athletic goods, and the person so connected has to do with tennis goods to no greater extent than with any other line of goods"; and

WHEREAS, In order to carry out the wishes of the annual meeting it is necessary for the Executive Committee to find out the facts in regard to all players connected with the manufacture or sale of tennis goods; be it

RESOLVED, That the Executive Committee requires all players who are engaged in any way with the tennis goods business to furnish E. F. Torrey, Secretary, P. O. Box 146, Clinton, N. Y., with a memorandum, before June 1, each year, covering their activity for the previous year along the following lines:

First, the number of tournaments played in and the actual amount of time absent from business;

Second, a statement of the extent with which he individually has to do with tennis goods, as compared with other lines of goods manufactured or sold by the firm with which he is connected, together with a statement of the exact value of goods sold by him, sub-divided into the actual value of tennis goods sold, golf goods sold, base ball goods sold, and the total value of all other lines of goods sold; and be it further

RESOLVED, That any player purposing to enter the employ of a sporting goods firm or to go into the sporting goods business, shall before so doing furnish in writing to E. F. Torrey, Secretary, P. O. Box 146, Clinton, N. Y., all the facts relating to such employment or business; and, be it further

RESOLVED, That a sub-committee be appointed to take final action on the information thus assembled, and where it appears that a player has broken the rules, to suspend him from further tournament play, unless he can show that at the present time he has corrected his infringement of the rule.

---

## DAVIS CUP

The annual meeting of the United States National Lawn Tennis Association, February 7, 1919, adopted the following resolution:

WHEREAS, The world war has ended; and

WHEREAS, There has been no international competition since 1914; and

WHEREAS, The resumption of such contests will help cement international friendships; now, therefore, be it

RESOLVED, That the annual meeting of the U.S.N.L.T.A. empower its Executive Committee to take such steps as may be necessary to re-establish the Davis Cup contests, the next one to be held in 1920; and be it further

RESOLVED, That the Executive Committee be hereby empowered to defray the expenses of such competition from the treasury of the U.S. N.L.T.A.

---

## PRIZES

The same meeting adopted the following resolution:

WHEREAS, One of the great expenses of holding tournaments has been due to the cost of prizes; and

WHEREAS, Players have come to regard certificates as highly as more expensive trophies; now, therefore, be it

RESOLVED, That the U.S.N.L.T.A. recommend to its member clubs that no prizes of intrinsic value be given during 1919, but that certificates similar to those used in 1917 and 1918 be awarded, or standard medals authorized by the U.S.N.L.T.A.

## FOOT FAULT RULE

The Executive Committee urge players to carefully observe and clubs to rigidly enforce the Foot Fault Rule. Clubs holding officially sanctioned tournaments are requested to appoint a foot fault umpire for every match and to include in the printed announcement of their tournaments the direct information that "THE FOOT FAULT RULE WILL BE RIGIDLY ENFORCED," together with a copy of the rule (see page 279).

The National Umpires' Association will make every effort to help clubs obtain foot fault umpires.

## Fixtures for 1919

- April 7—Pinehurst Country Club, Pinehurst, N. C.; first annual United North and South championship.
- April 20—Vedado Tennis Club, Havana, Cuba; open tournament.
- May 10—Harlem Tennis Club, New York City; open tournament.
- May 10—Women's Park Tennis Club, San Francisco, Cal.; San Francisco champ., women.
- May 12—Longwood Cricket Club, Boston, Mass.; New England intercollegiate champ.
- May 19—Essex County Country Club, West Orange, N. J.; Essex County championship.
- May 19—New Rochelle Tennis Club, New Rochelle, N. Y.; Quaker Ridge championship.
- May 24—Plymouth Country Club, Norristown, Pa.; championship of Schuylkill Valley.
- May 27—Pelham Country Club, Pelham Manor, N. Y.; women's invitation tournament.
- May 27—Amackassin Club, Yonkers, N. Y.; invitation tournament.
- May 30—Columbia Country Club, Chevy Chase, Md.; Middle Atlantic championship; Middle Atlantic sectional doubles championship.
- May 30—Douglas Country Club, Douglas, Ariz.; Border States championship.
- May 30—North Hempstead Country Club, Port Washington, L. I.; Nassau and Queens County championship.
- May 30—Brae-Burn Country Club, West Newton, Mass.; Massachusetts State doubles championship.
- May 30—Westchester County Association, Westchester, N. Y.; championship of Westchester County; closed.
- June 2—Montclair Athletic Club, Montclair, N. J.; New Jersey champ., men (closed).
- June 2—Country Club of Westchester, Westchester, N. Y.; invitation tournament.
- June 2—West Side Tennis Club, Forest Hills, L. I.; Metropolitan women's champ.
- June 2—Merion Cricket Club, Haverford, Pa.; women's championship of Pennsylvania and Eastern States.
- June 4—Country Club of Northampton County, Easton, Pa.; championship of Lehigh Valley.
- June 7—New York Tennis Club, New York City; Bronx County championship, Manhattan doubles and husbands' and wives' tournament.
- June 9—The Ardsley Club, Ardsley-on-Hudson, N. Y.; women's invitation tournament.
- June 9—Country Club of Virginia, Richmond, Va.; Old Dominion tournament.
- June 9—Merion Cricket Club, Haverford, Pa.; Pennsylvania State championship, men.
- June 9—Chicago Tennis Club, Chicago, Ill.; Chicago championship.
- June 9—Wilmington Country Club, Wilmington, Del.; Delaware State champ., women.
- June 9—Hartford Golf Club, Hartford, Conn.; New England championship.
- June 10—Bloomfield Tennis Club, Bloomfield, N. J.; tournament for teams of North Jersey and East Passaic Valley Tennis Associations.
- June 10—University of Texas, Austin, Tex.; Texas State championship.
- June 13—Longwood Cricket Club, Boston, Mass.; Church Cup match.
- June 14—Longwood Cricket Club, Boston, Mass.; Massachusetts State championship, men.
- June 16—Terrace Club of Flatbush, Brooklyn, N. Y.; Brooklyn championship.
- June 16—Sans Souci Country Club, Greenville, S. C.; championship of the Carolinas.
- June 16—Philadelphia Cricket Club, Philadelphia, Pa.; women's championship of the United States; girls' championship of the United States; mixed doubles championship of the United States.
- June 16—Baltimore Country Club, Baltimore, Md.; Maryland State championship.
- June 21—Kings County Tennis Club, Brooklyn, N. Y.; Long Island championship.
- June 21—Cleveland Associated Tennis Clubs, Cleveland, O.; Cleveland championship, men.
- June 21—Falls City championship, at Central Park, Louisville, Ky.
- June 21—Berkeley Tennis Club, Berkeley, Cal.; Pacific Coast championship.
- June 23—Wilmington Country Club, Wilmington, Del.; Delaware State championship, men.
- June 23—Orange Lawn Tennis Club, Orange, N. J.; Middle States championship.

- June 23—Lewiston Country Club, Lewiston, Idaho; Idaho State championship.  
 June 23—Augusta Country Club, Augusta, Ga.; South Atlantic States championship.  
 June 23—Rockhill Tennis Club, Kansas City, Mo.; Great Plains women's championship.  
 June 27—Nassau Country Club, Glen Cove, L. I.; invitation tournament.  
 June 28—University Heights Tennis Club, New York City; North Side championship.  
 June 28—Berkeley Tennis Club, Berkeley, Cal.; Alameda County championship.  
 June 28—Kansas City Field Club, Kansas City, Mo.; Missouri State championship.  
 June 30—St. Louis Amateur Athletic Association, St. Louis, Mo.; Central States championship, women.  
 June 30—Engleside Tennis Club, Beach Haven, N. J.; Independence Day tournament.  
 June 30—Spokane Tennis Club, Spokane, Wash.; Inland Empire championship.  
 June 30—Country Club of Springfield, Springfield, Mass.; Connecticut Valley champ.  
 July 3—Pittsburgh Athletic Association, Pittsburgh, Pa.; Western Pennsylvania champ.  
 July 4—Long Beach Club, Los Angeles, Cal.; California sectional doubles championship.  
 July 5—Mount Pleasant Tennis Club, Pleasantville, N. Y.; Eastern New York State championship.  
 July 7—Noelton Country Club, Nashville, Tenn.; Tennessee State championship.  
 July 7—Brocton Country Club, Campello, Mass.; Plymouth County championship.  
 July 7—St. Louis Amateur Athletic Association, St. Louis, Mo.; Central States championship, men.  
 July 10—Ohio Lawn Tennis Association, Cincinnati, Ohio; East-West team match.  
 July 12—Stamford Yacht Club, Stamford, Conn.; Stamford championship.  
 July 12—Engleside Tennis Club, Beach Haven, N. J.; Central New Jersey championship.  
 July 14—South Side Tennis Club, Chicago, Ill.; clay court championship of the United States.  
 July 14—Multnomah Amateur Athletic Club, Portland, Ore.; Oregon State championship.  
 July 14—Park Club, Buffalo, N. Y.; championship of the Great Lakes; Western New York championship.  
 July 14—Woodmere Club, Woodmere, N. Y.; men's open tournament.  
 July 16—Yahundasis Golf Club, Utica, N. Y.; New York State championship.  
 July 17—Field Club of Greenwich, Greenwich, Conn.; invitation tournament.  
 July 17—Bathing and Tennis Club, Spring Lake Beach, N. J.; North Jersey Coast champ.  
 July 19—Milwaukee Tennis Association, Milwaukee, Wis.; Milwaukee championship.  
 July 19—Minnetonka Yacht Club, Deephaven, Minn.; Northwestern championship; Northwestern sectional doubles championship.  
 July 21—Cleveland Associated Tennis Clubs, Cleveland, Ohio; Tri-State sectional doubles championship.  
 July 21—Longwood Cricket Club, Boston, Mass.; Longwood singles; New England sectional doubles championship.  
 July 21—Asheville Country Club, Asheville, N. C.; Southern championship; Southern sectional doubles championship.  
 July 26—Cynwyd Club, Philadelphia, Pa.; championship of Eastern Pennsylvania.  
 July 28—Wentworth Lawn Tennis Club, New Castle, N. H.; open tournament.  
 July 28—Western Michigan Tennis Association, Grand Rapids, Mich.; Western Michigan championship.  
 July 28—Seabright Lawn Tennis and Cricket Club, Seabright, N. J.; invitation tournament; Middle States sectional doubles championship.  
 July 28—Dallas Lawn Tennis Club, Dallas, Tex.; Southwestern championship; Southwestern sectional doubles championship.  
 July 28—Rockhill Tennis Club, Kansas City, Mo.; Western championship; Western sectional doubles championship.  
 July 28—Woodmere Club, Woodmere, N. Y.; women's tournament.  
 July 28—Cleveland Associated Tennis Clubs, Cleveland, O.; Cleveland champ., women.  
 July 29—Crawford Notch Tennis Club, Crawford Notch, N. H.; New Hampshire State and White Mountains championship.  
 July 30—Hoosick Falls Country Club, Hoosick Falls, N. Y.; Hoosac Valley championship.  
 July 31—Gooseck Country Club, Lee, Mass.; invitation tournament.  
 Aug. 2—Worcester Tennis Club, Worcester, Mass.; open tournament.  
 Aug. 2—Oakland Tennis Club, Oakland, Cal.; Oakland championship.  
 Aug. 4—Newport Lawn Tennis Club, Newport, R. I.; invitation tournament.  
 Aug. 4—Detroit Tennis Club, Detroit, Mich.; Michigan State championship.  
 Aug. 4—Sioux City Lawn Tennis Association, Sioux City, Iowa; Interstate champ.  
 Aug. 4—Jeannette Tennis Club, Jeannette, Pa.; Westmoreland County championship.  
 Aug. 4—Iron Mountain Tennis Club, Jackson, N. H.; championship East Side of White Mountains.  
 Aug. 4—Cascade Tennis Club, Atlanta, Ga.; Georgia State championship.  
 Aug. 4—Portland Country Club, Falmouth, Me.; open tournament.  
 Aug. 4—Tacoma Lawn Tennis Club, Tacoma, Wash.; Pacific Northwest championship.  
 Aug. 4—Atlantic City Yacht Club, Atlantic City, N. J.; Atlantic City championship.  
 Aug. 5—Country Club of Norfolk, Norfolk, Conn.; Connecticut State championship.  
 Aug. 9—Long View Tennis Club, Duluth, Minn.; Head of the Lakes championship.  
 Aug. 9—Engleside Tennis Club, Beach Haven, N. J.; Beach Haven championship.  
 Aug. 9—Bedford Springs Tennis Club, Bedford Springs, Pa.; championship of Southern Pennsylvania.

- Aug. 11—Rockaway Hunting Club, Cedarhurst, N. Y.; men's invitation tournament.  
 Aug. 11—Birmingham Country Club, Birmingham, Ala.; Cotton States championship.  
 Aug. 11—Inlet Terrace Club, Belmar, N. J.; open tournament.  
 Aug. 11—Seattle Tennis Club, Seattle, Wash.; Washington State championship.  
 Aug. 11—Happy Hollow Tennis Club, Owatonna, Minn.; Southern Minnesota champ.  
 Aug. 12—Longwood Cricket Club, Boston, Mass.; doubles championship of the United States.  
 Aug. 16—Agawam Hunt Club, Providence, R. I.; Rhode Island State championship.  
 Aug. 16—Cleveland Associated Tennis Clubs, Cleveland, Ohio; Ohio State championship.  
 Aug. 16—Kansas City Athletic Club, Kansas City, Mo.; Missouri Valley championship.  
 Aug. 18—Meadow Club, Southampton, N. Y.; invitation tournament.  
 Aug. 18—Bayhead Yacht Club, Bayhead, N. J.; open tournament.  
 Aug. 18—Lake George Club, Diamond Point-on-Lake George, N. Y.; championship of Lake George.  
 Aug. 23—Squirrel Island Athletic Assn., Squirrel Island, Me.; Southern Maine champ.  
 Aug. 23—Fort Wayne Country Club, Fort Wayne, Ind.; Indiana State championship.  
 Aug. 23—Ocean City Yacht Club, Ocean City, N. J.; South Jersey open tournament.  
 Aug. 23—Northwestern Tennis Association, Minneapolis, Minn.; Minnesota State champ.  
 Aug. 25—West Side Tennis Club, Forest Hills, L. I.; singles championship of the United States; junior and boys' championship of the United States; veterans' championship of the United States; father and son championship of the United States.  
 Aug. 25—Rockaway Hunting Club, Cedarhurst, N. Y.; women's invitation tournament.  
 Aug. 25—Asheville Country Club, Asheville, N. C.; championship of North Carolina.  
 Aug. 25—Eagles Mere Athletic Association, Eagles Mere, Pa.; Eagles Mere championship.  
 Aug. 25—Denver Country Club, Denver, Colo.; Colorado State championship.  
 Aug. 25—Kansas City Field Club, Kansas City, Mo.; Missouri State championship; mixed doubles.  
 Aug. 25—Stockbridge Golf Club, Stockbridge, Mass.; Western Massachusetts champ.  
 Aug. 26—Altoona Cricket Club, Altoona, Pa.; Central Pennsylvania championship.  
 Aug. 30—Country Club of Pittsfield, Pittsfield, Mass.; Berkshire County championship.  
 Aug. 30—Engleside Tennis Club, Beach Haven, N. J.; Labor Day tournament.  
 Aug. 30—Audubon Country Club, Louisville, Ky.; Kentucky State championship.  
 Sept. 1—Chicago Tennis Club, Chicago, Ill.; Illinois State championship.  
 Sept. 1—Niagara Lawn Tennis Club, Niagara-on-the-Lake, Can.; international champ.  
 Sept. 1—Woodmere Club, Woodmere, L. I.; mixed doubles tournament.  
 Sept. 1—Talbot Country Club, Easton, Md.; Peninsula championship.  
 Sept. 6—Dumbarton Club, Washington, D. C.; District of Columbia championship.  
 Sept. 6—Westfield Golf Club, Westfield, N. J.; Westfield championship.  
 Sept. 6—Berkeley Tennis Club, Berkeley, Cal.; California State championship.  
 Sept. 6—Indiana Tennis Association, Indianapolis, Ind.; Tri-State championship, singles.  
 Sept. 8—Merimantown Cricket Club, Philadelphia, Pa.; Philadelphia and District champ.  
 Sept. 8—Merion Cricket Club, Philadelphia, Pa.; intercollegiate championship of the United States.  
 Sept. 8—Rockhill Tennis Club, Kansas City, Mo.; Great Plains mixed doubles champ.  
 Sept. 8—New York Tennis Club, New York City; New York State champ., women's.  
 Sept. 10—Scranton Country Club, Scranton, Pa.; championship of Northeastern Pennsylvania.  
 Sept. 11—Edgewood Country Club, Charleston, W. Va.; invitation tournament.  
 Sept. 15—Longwood Cricket Club, Boston, Mass.; women's tournament.  
 Sept. 15—East Side Tennis Club, Providence, R. I.; Rhode Island clay court champ.  
 Sept. 15—Hoboken Tennis Club, Hoboken, N. J.; Castle Point tournament.  
 Sept. 22—Orange Lawn Tennis Club, South Orange, N. J.; New Jersey State championship, women.  
 Sept. 22—Agawam Hunt Club, Providence, R. I.; Rhode Island State champ., women.  
 Oct. 4—Golden Gate Park Club, San Francisco, Cal.; Bay Counties championship.  
 Oct. 6—Virginia Hot Springs, Hot Springs, Va., open tournament.  
 Oct. 10—Essex County Country Club, West Orange, N. J.; mixed doubles tournament.  
 Oct. 11—Women's Park Tennis Club, San Francisco, Cal.; Bay Counties champ., women.  
 Oct. 13—Greenbrier Tennis Club, White Sulphur Springs, W. Va.; open tournament.  
 Dec. 22—Seventh Regiment Tennis Club, New York City; junior and boys' indoor championship of the United States.
- 1920.
- Feb. 2—Heights Casino, Brooklyn, N. Y.; women's invitation singles.  
 Feb. 18—Palm Beach Tennis Club, Palm Beach, Fla.; Florida State championship.  
 Feb. 23—Sunshine Tennis Club, St. Petersburg, Fla.; West Coast championship of Florida.  
 Mar. 15—Seventh Regiment Tennis Club, New York City; women's and girls' indoor championship of the United States.  
 Mar. 27—Seventh Regiment Tennis Club, New York City; men's indoor championship of the United States.

## List of Members

- Aberdeen Tennis Club, Brighton, Boston, Mass.—Pres., Thomas M. Worthley; Sec., Frank J. Berry, 134 Sutherland Road, Brookline, Mass.; Treas., William A. White.
- Agawam Hunt Club, East Providence, R. I.—Sec., F. E. Richmond; Treas., John A. Cave; Ch. T.C., Edwin A. Barrows, Turks Head Bldg.
- Albany (N. Y.) Country Club—Sec., Fred A. Mix; Treas., James MacAredie; Ch. T.C., William A. Visscher, 126 State St.
- Allegheny Country Club, Sewickley, Pa.—Sec., O. D. Thompson, Sewickley, Pa., and Park Bldg., Pittsburgh; Treas., W. C. Robinson, Fulton Bldg., Pittsburgh; Ch. T.C., O. D. Thompson, c/o Club.
- Altoona (Pa.) Cricket Club—Sec.-Treas., H. M. Chenoweth; Ch. T.C., C. R. McMillan, 952 26th St.
- Amackassin Club, Yonkers, N. Y.—Sec., Wilfred A. Daly, 159 Glenwood Ave.; Treas., C. Stanley Mitchell, 12 Dudley Place; Ch. T.C., John A. Beaver, 58 Towers Place, and 120 Broadway, New York City.
- American Bridge Company of Philadelphia, Philadelphia, Pa.—Sec.-Ch. T.C., Thomas Ogden, Pencoyd Plant, Pencoyd, Pa.; Treas., E. Hunter Lord, Pencoyd Plant.
- Apawamis Club, Rye, N. Y.—Sec., Howard E. White, 31 Nassau St., New York City; Treas., J. S. McCulloch, 15 Day St., New York City; Ch. T.C., H. D. Montgomery, 49 Wall Street, New York City.
- Ardmore (Pa.) Tennis Club—Sec., William F. MacDowell; Treas., Robert S. Stumpers.
- Ardsey Club, Ardsley-on-Hudson, N. Y.—Sec., George E. Dickman; Treas., H. L. R. Edgar, c/o Club; Ch. T.C., J. Terry West, 71 Broadway, New York City.
- Arundel Casino, Kennebunkport, Me.—Sec.-Ch. T.C., David P. Cummings, 183 Essex St., Boston, Mass.; Treas., S. P. Bancroft.
- Asheville (N. C.) Country Club—Sec.-Treas., R. H. Boyer; Ch. T.C., F. W. Thomas.
- Atlantic City (N. J.) Yacht Club—Sec., Warner Lindsay, Jr., Guaranty Trust Bldg.; Treas., A. G. Rohr, 5 N. Cambridge Ave., Ch. T.C., F. E. Adams, (Summer) 18 N. Iowa Ave.; (Winter) 18 E. Division St., Chicago, Ill.
- Atlantic Yacht Club, Sea Gate, N. Y.—Sec., Edward A. Graff, 60 Broadway, New York City; Treas., P. H. Hart, c/o John Wanamaker, New York City; Ch. T.C., W. A. Saxton, Jr., 174 Duane St., New York City.
- Baltimore (Md.) Country Club—Sec., W. Stuart Symington, Jr., 1010 Maryland Trust Bldg.; Treas., Alexander P. Knopp, U. S. Fidelity and Guarantee Co.; Ch. T.C., J. Craig McLanahan, Maryland Casualty Tower.
- Bathing and Tennis Club, Spring Lake Beach, N. J.—Sec., F. W. Roebbling, Trenton, N. J.; Treas.-Ch. T.C., Arthur Corlies, 61 Broadway, New York City.
- Bayhead (N. J.) Yacht Club—Sec., Louis O. Brewster; Treas., W. A. Drisler, 334 Fourth Ave., New York City; Ch. T.C., R. H. Metcalfe.
- Beaver Hills Tennis Club, New Haven, Conn.—Sec., Miss Ruth Herman, 23 Lynwood Place; Treas.-Ch. T.C., Edwin C. Perkins, 390 Norton St.
- Bedford Springs (Pa.) Tennis Club—Sec., M. C. Sweeney; Treas., J. J. Barclay; Ch. T.C., R. C. Hall.
- Bellfield Country Club, Philadelphia, Pa.—Sec., H. P. Cochrane, 1435 Cayuga St.; Treas., T. S. Snowden, 331 W. School Lane; Ch. T.C., C. Barbour, 42 N. Ninth St.
- Belleair (Fla.) Country Club—Sec.-Treas., B. F. Sherwood, The Belleview; Ch. T.C., C. S. Kron.
- Beretania Tennis Club, Honolulu, H. I.—Pres., E. H. Wodehouse; Capt. T.C., A. L. Castle, P. O. Box 349.
- Bergen Point Tennis Club, Bayonne, N. J.—Sec.-Treas., Fred W. Shaw, Jr., 82 W. 35th St.
- Bethlehem (N. H.) Country Club—Sec., Benjamin Tucker; Treas., Fred C. Abbe.
- Binghamton (N. Y.) Tennis Club—Sec., N. S. Douglas, 128 State St.; Ch. T.C., R. W. Titus, Press Bldg.
- Birmingham (Ala.) Country Club—Sec.-Treas., D. F. Dienna, c/o Club; Ch. T.C., R. D. Johnston, Jr., American Trust Bldg.
- Bismarck (N. D.) Tennis Club—Sec., Burt Finney; Treas.-Ch. T.C., G. H. Russ, Jr.
- Bloomfield (N. J.) Tennis Club—Sec., L. T. Smith, 116 Thomas St.; Treas., S. M. Perrine, 172 Berkley Ave.
- Boston (Mass.) Athletic Association—Sec., Herbert W. Gidney; Treas., Hollis H. Sawyer; Ch. T.C., Edward W. Babb.
- Brae Burn Country Club, West Newton, Boston, Mass.—Sec.-Ch. T.C., Edward F. Woods, 98 Milk St.; Treas., William A. Young, 30 State St.
- Bridgeport (Conn.) Y.M.C.A. Tennis Club—Sec.-Treas., Frank M. Fosdick, Bridgeport Savings Bank; Ch. T.C., Dr. R. Warren Hall, 60 Park St.
- Broekton (Mass.) Country Club—Sec., Donald M. Keith, 1348 Main St., Campello, Mass.; Treas., Chester W. Dailey, 239 Market St., Campello; Ch. T.C., C. W. Burrill, c/o George Keith Co., Campello.
- Bronxville (N. Y.) Athletic Association—Sec.-Treas., A. Comstock; Ch. T.C., Herman Suter.

- Brooklawn Country Club, Bridgeport, Conn.—Sec., Charles A. Baldwin, P. O. Box 376; Treas., Frank J. Staples, 189 State St.
- Brooklyn (N. Y.) Tennis Club—Sec., W. Harvey Thallon, 7 Wall St., New York City; Treas., Arthur A. Hassell, 30 Nassau St., New York City; Ch. T.C., Henry Wallace.
- Castle Point Tennis Club, Hoboken, N. J.—Sec.-Treas., O. S. Campbell, New York Stock Exchange, New York City; Ch. T.C., Richard Stevens, 1 Newark St.
- Catonsville (Md.) Country Club—Sec., Benjamin Whitely; Treas., G. Clem Goodrich; Ch. T.C., C. W. Harvey.
- Central Y.M.C.A. Tennis Club, Trenton, N. J.—Sec., Charles B. West, 235 Rosemont Ave.; Treas., Roy Glover, General Green Ave.; Ch. T.C., Lloyd H. Rockhill, 710 Riverside Ave.
- Century Country Club, White Plains, N. Y.—Sec., Walter E. Beer, 52 Broadway, New York City; Treas., C. I. Stralem, 5 Nassau St., New York City; Ch. T.C., Joseph W. Sidenberg, 114 Fifth Ave., New York City.
- Cherry Valley Club, Garden City, L. I., N. Y.—Sec., William M. Cruikshank; Treas., C. LeRoy Henderson; Ch. T.C., Donald C. Vaughan.
- Chevy Chase (Md.) Club—Sec., H. Prescott Gatley, 230 Indiana Ave., N.W., Washington, D. C.; Treas., Charles J. Bell, American Security and Trust Co., Washington, D. C.; Ch. T.C., Edward W. Donn, Jr., 808 17th St., Washington, D. C.
- Cohasset (Mass.) Golf Club—Sec., C. Glover Crocker, 50 Congress St., Boston, Mass.; Treas., George B. Dawson, 84 State St., Boston, Mass.; Ch. T.C., Matthew Luce.
- Colonial Heights Tennis Club, Yonkers, N. Y.—Sec., Roys N. Brown, Armour Villa Park, Bronxville, N. Y.; Treas., M. C. Underhill, Colonial Heights, Tuckahoe, N. Y.; Ch. T.C., Charles Blauvelt, Colonial Heights, Tuckahoe, N. Y.
- Columbia Country Club, Washington, D. C.—Sec., A. B. Shelton, Chevy Chase, Md.; Treas., John Poole, 14th and G Sts., N.W., Washington, D. C.; Ch. T.C., A. Y. Leech, Jr., 719 15th St., N.W., Washington, D. C.
- Columbia University Tennis Association, New York City—Graduate Manager of Athletics. Carlos Contreras.
- Cooperstown (N. Y.) Country Club—Sec., Douglas J. Johnston, 149 Broadway, New York City; Ch. T.C., Waldo C. Johnston.
- Coronado Country Club, San Diego, Cal.—Sec., Colin G. Ross, 244 Union Bldg.; Treas., A. H. Keyser, 244 Union Bldg.; Ch. T.C., William J. Thayer, 2468 Albatross St.
- Country Club, Brookline, Mass.—Ch. T.C., George B. Morison, 201 Devonshire St., Boston, Mass.
- Country Club, Buffalo, N. Y.—Sec., Langdon B. Wood; Treas., Jesse C. Dann; Ch. T.C., Roswell Park, White Bldg.
- Country Club, Cleveland, Ohio—Sec., W. C. Seegar, 711 Cuyahoga Bldg.; Ch. T.C., William Collins, 1300 Leader-News Bldg.
- Country Club of New Bedford, New Bedford, Mass.—Sec.-Treas., Henry S. Knowles, P. O. Box 758 (112 Cottage St.); Ch. T.C., Milton S. Coffin, 34 Seventh St.
- Country Club, Norfolk, Va.—Sec.-Treas., F. Garnett Jordan; Ch. T.C., F. C. Lewis, Dickson Bldg.
- Country Club of Northampton County, Easton, Pa.—Sec.-Treas., J. Ingham Kinsey, Easton Trust Bldg.; Ch. T.C., J. Wagner Green, 520 McCartney Bldg.
- Country Club of Pittsfield, Pittsfield, Mass.—Sec., Walter C. Kellogg, 7 North St.; Treas., C. H. Buckingham, 24 North St.
- Country Club of Scranton, Scranton, Pa.—Sec., Dr. George G. Lindsay, Scranton Life Bldg.; Treas., Harry S. Robinson, 1540 Wyoming Ave.; Ch. T.C., Edwin Shafer, Lincoln Trust Bldg.
- Country Club of Springfield, Springfield, Mass.—Sec., Orison E. Hovis, 17 Kenwood Terrace; Treas., Clarence B. Clark, Phelps Publishing Co.; Ch. T.C., Thomas L. Jefferson, Jr., Package Machinery Co.
- Country Club of Virginia, Richmond, Va.—Sec.-Treas., H. B. Fitzgerald, c/o Club; Ch. T.C., John A. Coke, Jr., 1111 E. Main St.
- Country Club of Waterbury, Waterbury, Conn.—Sec.-Ch. T.C., S. P. Williams, Jr., 109 Bank St.; Treas., Robert Hannegan, Second Ave.
- Country Club of Westchester County, Westchester, N. Y.—Sec., Hjalmer H. Boyesen, 49 Wall St., New York City; Treas., Eugene H. Rosenquest, Country Club Grounds; Ch. T.C., George T. Adee, 62 Broadway, New York City.
- County Tennis Club of Westchester, Greenacres, Hartsdale, N. Y.—Sec., Eugene A. Clark, 4 Cottage Ave., White Plains; Ch. T.C., George A. Walker, Jr.; Treas., John F. Krepps, Home Savings Bank, White Plains, N. Y.
- Crawford Notch (N. H.) Tennis Club—Sec., W. A. Barron, Crawford House; Treas., Frederick Holbrooke, Yonkers, N. Y.; Ch. T.C., Dr. W. Z. Bradford, Newbury St., Boston, Mass.
- Crescent Athletic Club, Brooklyn, N. Y.—Sec., Augustin S. Hart, c/o Club; Treas., Guthrie B. Plante, c/o Club; Ch. T.C., Arthur R. Neill, 77 Franklin St., New York City.
- Crescent Tennis Club, New Orleans, La.—Sec., Irving R. Saal, 917 Whitney Bldg.; Ch. T.C., Sidney L. Fiebleman, 407 Whitney Bldg.
- Cynwyd (Pa.) Club—Sec.-Treas., Frank E. Baker, 515 Commercial Trust Bldg., Philadelphia, Pa.; Ch. T.C., Charles N. Beard.



- Dayton (Ohio) Country Club—Sec.-Treas., W. W. Sunderland, 1826 S. Main St.; Ch. T.C., Rowland H. McKee, 707 Schwind Bldg.
- Dedham (Mass.) Country and Polo Club—Sec., Lombard Williams, 75 State St., Boston, Mass.; Treas., Joseph B. Russell, Jr., 108 Water St., Boston, Mass.; Ch. T.C., Harold F. Mason, 259 Summer St., Boston, Mass.
- Denver (Colo.) Country Club—Sec., Frank J. Denison, Drivers State Bank; Treas., A. C. Foster, Sweet, Causey, Foster Inv. Co.; Ch. T.C., John Morey, Morey Merc. Co.
- Departmental Tennis League, Washington, D. C.—Sec.-Treas., L. I. Doyle, 1350 Otis Place, N.W., Washington, D. C.
- Des Moines (Iowa) Golf and Country Club—Sec., P. E. Coffey, 101 E. Sixth St.; Treas., E. A. Slininger, Peoples Savings Bank.
- Des Moines (Iowa) Golf and Tennis Club—Sec.-Ch. T.C., John C. DeMar, 711 Cracker Bldg.; Treas., H. H. VanEvers, Securities Bldg.
- Detroit (Mich.) Tennis Club—Sec.-Ch. T.C., N. H. Bowen, 154 Fort St., West; Treas., E. H. Spicer, 50 Elliot St.
- Dumbarton Club, Washington, D. C.—Sec., G. Gould Lincoln, c/o Club; Treas., Boyd Taler, Washington Loan and Trust Co.; Ch. T.C., Samuel Herrick, Westory Bldg.
- Dunwoody Country Club, Yonkers, N. Y.—Sec., David H. Thomas, c/o Club; Treas., W. Willard Babcock, 1750 Amsterdam Ave., New York City; Ch. T.C., Elmer Dean Coulter, 23 W. 26th St., New York City.
- Eagles Mere (Pa.) Athletic Association—Sec.-Treas., E. S. Chase; Ch. T.C., William Woods, 2 Lehman St., Philadelphia, Pa.
- East End Tennis Club, Cleveland, Ohio—Pres., S. W. Cabell, 1109 Guardian Bldg.
- East End Tennis Club, Columbus, Ohio—Sec., B. C. Hommon, c/o Wolfe Bros. Shoe Co.; Treas., C. M. Hinman, c/o Wolfe Bros. Shoe Co.; Ch. T.C., A. B. Nellis, 198 E. State St.
- East Side Tennis Club, Providence, R. I.—Sec., L. F. Baker, 79 Westminster St.; Treas., F. A. Otis, 539 Grosvenor St.; Ch. T.C., W. W. Binford, 256 Norris Ave.
- Edgewood (Pa.) Club—Sec., P. L. Crittendon, 134 Lincoln Ave.; Treas., W. W. Ramsey, Maple Ave.; Ch. T.C., Charles Garland, First National Bank Bldg., Pittsburgh, Pa.
- Edgewood Country Club, Charleston, W. Va.—Sec.-Treas., Berkley Minor, Jr.; Ch. T.C., Clarence B. Peck, 1221 Virginia St.
- Elberon Tennis Club, Fox Chase, Philadelphia, Pa.—Sec., William MacMurtrie, 6320 Woodlawn Ave.; Treas., I. W. Booth, Elberon Ave., Fox Chase; Ch. T.C., Albert J. Batty, 502 Strahle St.
- Elizabeth (N. J.) Town and Country Club—Sec., O. H. C. Keys, Broad St.; Treas., Philip Ricketts, c/o Club; Ch. T.C., R. M. Kirkland, 120 Broad St.
- Elmhurst Tennis Club, Elmhurst, L. I., N. Y.—Sec., Nathaniel V. Garretson, 203 Gleane St.; Treas., Miss Emily Curry, 114 Gleane St.
- Engleside Tennis Club, Beach Haven, N. J.—Pres., R. F. Engle, c/o The Engleside; Sec.-Treas., Lee Foshay, c/o Club.
- Englewood (N. J.) Field Club—Pres., Louis Coe, 35 Warren St., New York City; Sec., J. Wright Taussig; Treas., Dudley T. Humparey; Ch. T.C., W. E. Loughman.
- Essex Country Club, Manchester, Mass.—Sec., D. L. Pickman, Jr., 84 State St., Boston, Mass.; Treas., Henry S. Grew, 40 State St., Boston, Mass.; Ch. T.C., Philip Stockton, Old Colony Trust Co., Boston, Mass.
- Essex County Country Club, West Orange, N. J.—Sec., Harry Bottoms, c/o Club; Treas., Edward H. Graves, 115 Broadway, New York City; Ch. T.C., Allen C. Bragaw, 165 Broadway, New York City.
- Fairmont Tennis Club, Port Chester, N. Y.—Sec.-Treas., J. Walter Ingham, 203 Grace Church St.; Ch. T.C., Piercy Culyer.
- Fairmont (W. Va.) Country Club—Sec.-Treas., John H. Rock; Ch. T.C., A. J. Calhorn.
- Fairview Country Club, Elmford, N. Y.—Sec., Norman B. Cohen, 694 Broadway, New York City; Treas., Fred R. Seeman, 121 Hudson St., New York City; Ch. T.C., Harry C. Bandler, 2 Rector St., New York City.
- Field Club of Greenwich, Greenwich, Conn.—Sec., Clement Cleveland, Jr., 55 Wall St., New York City; Treas., James T. Scutter; Ch. T.C., Ralph G. Coburn, 30 Church St., New York City.
- Florida Country Club, Jacksonville, Fla.—Sec., C. S. L'Engle; Treas., Joe J. Avent; Ch. T.C., Bayless W. Haynes, c/o Wilson-Toomer Fertilizer Co.
- Garden City Club, Garden City, L. I., N. Y.—Sec., J. R. Savage, 71 Hilton Ave.; Treas., Henry A. Frey, 5th St.; Ch. T.C., Dudley A. Fuller, Jr.
- Gedney Farms Country Club, White Plains, N. Y.—Sec., William T. Hart, 12 E. 44th St., New York City; Treas., C. H. Mitchell, 12 E. 44th St., New York City.
- Germantown Cricket Club, Germantown, Pa.—Sec., George Purviance, c/o Club; Treas., Lewis W. Wister, c/o Club; Ch. T.C., William H. Connell, c/o Club.
- Germantown Tennis Club, Philadelphia, Pa.—Sec., Richard Maelver, 18 E. Garfield St.; Treas., Walter K. Smth, 282 W. Haines St.; Ch. T.C., Richard L. Miller, 128 E. Washington Lane, Germantown, Philadelphia, Pa.
- Glen Ridge (N. J.) Tennis Club—Sec., James D. Benedict, 7 Douglas Road; Treas., F. E. Pratt, 45 Hamilton Road; Ch. T.C., B. Frank Carter, 30 Appleton Place.
- Glenside (Pa.) Tennis Club—Sec., W. T. Moyer; Treas., C. E. Marvin; Ch. T.C., J. M. Anderson.

- Glenwood Tennis Club, East Orange, N. J.—Sec., A. D. Snow, 119 Park Ave.; Treas., W. V. Ruton, Jr., 236 Glenwood Ave.; Ch. T.C., L. S. Hobbie, Roseville Athletic Assn., Newark, N. J.
- Greenbrier Tennis Club, White Sulphur Springs, W. Va.—Sec.—Treas., J. M. Ayres; Ch. T.C., Howard Slocum.
- Green Meadow Country Club, Harrison, N. Y.—Sec., Albert T. Maurice, 35 Nassau St., New York City; Treas., Charles Smithers, 19 Nassau St., New York City; Ch. T.C., Le Baron S. Willard, 8 Bridge St., New York City.
- Greenock Country Club, Lee, Mass.—Sec., Mrs. J. M. Deely, Whiteholme Road; Treas., Malcolm Dunn, Sigma Phi House, Williamstown, Mass.; Ch. T.C., George F. Perkins, Hotchkiss School, Lakeville, Conn.
- Green Point Club, Philadelphia, Pa.—Sec., A. H. Summers, 2232 Fountain St.; Treas., Ralph Hothersall, 1431 Jerome St.
- Greenwich Casino Association, Greenwich, Conn.—Sec.—Treas., Ernest C. Wills.
- Greenwich (Conn.) Country Club—Sec., Calvin Truesdale, 120 Broadway, New York City; Treas., A. W. W. Marshall, The Greenwich Trust Co.
- Grinnell (Iowa) Country Club—Sec., B. J. Carney; Ch. T.C., Harold L. Beyer.
- Hackensack (N. J.) Golf Club—Sec., George E. Wells; Treas., C. H. Plenty; Ch. T.C., Frederick F. Fisher, 290 W. Clinton Place.
- Haddon Country Club, Haddonfield, N. J.—Sec., Clarence J. Hunter, 34 Mansion Ave.; Treas., Frank J. Middleton, Jr., 300 Westmont Ave.; Ch. T.C., W. G. Moore, 257 Kings Highway N.
- Hamilton Grange Tennis Club, New York City—Sec., Thomas L. Cunningham, 217 W. 116th St.; Treas., Elbert O. Smith, 1 W. 69th St.; Ch. T.C., Gus Steinacher, 505 Fifth Ave.
- Harlem Golf Club, New York City—Sec.—Treas., Edwin Bry, 7 W. 22d St.; Ch. T.C., Louis Bry, 7 W. 22d St.
- Hartford (Conn.) Golf Club—Sec., John W. Joy, 50 State St.; Treas., Robert C. Buell, 114 Vernon St.; Ch. T.C., Thomas W. Canfield, 18 Asylum St.
- Harvard Tennis Association, Cambridge, Mass.—Mgs., Charles E. Hodges, c/o Harvard Athletic Assn.; Asst. Mgr., W. W. Rowe, c/o Harvard Athletic Assn.
- Hawai Polo and Racing Club, Honolulu, H. I.—Ch. T.C., Alfred L. Castle, P. O. Box 349.
- Haworth (N. J.) Country Club—Sec.—Treas., J. E. McClernon, 35 Vestry St., New York City.
- Hawthorn Tennis Club, Indianapolis, Ind.—Pres., I. Watkins Pugh, Security Trust Co.; Sec., C. F. Davis, 451 Lemcke Annex; Treas., H. Walter Dunbar, 451 Lemcke Annex.
- Hay Harbor Club, Fishers Island, N. Y.—Sec.—Ch. T.C., Dr. B. H. Gray, 7 S. Boulevard, Richmond, Va.; Treas., Alfred L. Ferguson, 15 William St., New York City.
- Heights Casino, Brooklyn, N. Y.—Sec., Edward Cornell, 34 Nassau St., New York City; Treas., E. C. Granbery, 56 Williams St., New York City; Ch. T.C., George Roberts, 25 W. 11th St., New York City.
- Hermitage Country Club, Richmond, Va.—Sec.—Treas., W. C. Locker, P. O. Box 315; Ch. T.C., Lewis H. Blair, c/o Virginia Paper Co.
- Hoboken (N. J.) Tennis Club—Sec., J. C. Coleman, 57 13th St.; Treas.—Ch. T.C., Anton Grulich, 545 34th St., North Bergen, N. J.
- Hollywood Golf Club, Deal, N. J.—Sec., Milton S. Guiterman, 32 Liberty St., New York City; Ch. T.C., Sidney M. Sternbach.
- Hoosick Falls (N. Y.) Country Club—Sec., W. R. Gillette; Treas., Judson Puffer; Ch. T.C., Rev. Harry E. Pike.
- Hudson River Country Club, Inc., Yonkers, N. Y.—Sec.—Treas., H. F. L. Knobloch, 14 Wall St., New York City; Ch. T.C., R. R. Clayton, 67 Arthur St., Yonkers, N. Y.
- Huntingdon Valley Country Club, Philadelphia, Pa.—Sec., George H. Frazier, c/o Brown Bros. & Co.; Treas., William A. Law, c/o Club; Ch. T.C., E. B. Dewhurst, 1906 Chestnut St.
- Ilderan Outing Club, Rahway, N. J.—Sec., I. O. Bunn, 61 Maple Ave.; Treas., Stanley W. Jones, 163 Elm Ave.; Ch. T.C., Lindsay Dunham, 189 W. Milton Ave.
- Indoor Lawn Tennis Club, New York City—Sec.—Treas., Robert LeRoy, 212 W. 41st St.
- Inlet Terrace Club, Belmar, N. J.—Sec.—Treas., Frank C. Sievers; Ch. T.C., Dr. J. Wyllis Hassler.
- Iron Mountain Lawn Tennis Club, Jackson, N. H.—Sec., O. C. Harn, 111 Broadway, New York City; Treas., William L. Taylor, 47 Brevoort Place, Brooklyn, N. Y.; Ch. T.C., Herbert W. Abbott, 112 Beach St., Boston, Mass.
- Irvington Country Club, Portland, Ore.—Ch. T.C., A. R. Johnson, 1108 Northwestern Bank Bldg.
- Jacksonville (Fla.) Tennis Club—Sec., William H. Rogers, Heard Bank Bldg.; Treas., Fred B. Noble, Professional Bldg.; Ch. T.C., J. T. Hoag.
- Jeannette (Pa.) Club—Ch. T.C., F. A. Galer, 404 Clay Ave.
- Johnstown (Pa.) Country Club—Sec., Henry M. Rogers, Johnstown Trust Bldg.
- Kansas City (Mo.) Athletic Club—Ch. T.C., Harry A. Bennett, 300 Gumbel Bldg.
- Kansas City (Mo.) Field Club—Sec., John J. Lange, c/o Club; Treas., W. R. Waltner, c/o Club; Ch. T.C., M. D. Waltner, 504 Ridge Arcade.

- Kingsboro Tennis Club, Brooklyn, N. Y.—Sec., P. F. W. Ruther, 55 Wall Street, New York City; Treas., C. C. Schnecko, 163 Lefferts Ave.; Ch. T.C., J. H. B. Hedinger, 148 Maple St.
- Kings County Tennis Club, Brooklyn, N. Y.—Sec., James W. Anderson, 173 Amity St.; Treas., A. R. Platt, 87 Eighth Ave.
- Knickerbocker Field Club, Brooklyn, N. Y.—Sec., Henry Clay Reimer, 48 Westminster Road; Treas., Albert J. Wiley, 2104 Newkirk Ave.; Ch. T.C., Harland B. Tibbitts, 170 E. 17th St.
- Knollwood Country Club, White Plains, N. Y.—Sec., Dean S. Edmonds, 35 Nassau St., New York City; Treas., Walter H. Merrill, 135 W. 42d St., New York City; Ch. T.C., I. F. Wilcox, 118 E. 54th St., New York City.
- Lake George Club, Diamond Point-on-Lake George, N. Y.—Sec., Sidney Homer, Bolton-on-Lake George, N. Y.; Treas., M. L. C. Wilmarth, Gleus Falls, N. Y.; Ch. T.C., Miss Helen Simpson, 230 W. 76th St., New York City.
- Lancaster (Pa.) Country Club—Sec., George S. Franklin, 32 S. Prince St.; Treas., John J. Evans, E. Orange St.; Ch. T.C., T. S. Derr, Jr., c/o Lancaster Trust Co.
- Laureate Boat Club, Troy, N. Y.—Sec., B. P. Kavanaugh, 325 First St.; Treas., John Danahy, 2600 Sixth Ave.; Ch. T.C., W. G. Puffer, 807 Third Ave.
- Laurelhurst Club, Portland, Ore.—Sec., David H. Smith, 1125 Ankeny St., E.; Treas., J. P. Buchanan, 1125 Ankeny St., E.; Ch. T.C., Leonard C. Wilson, 1125 Ankeny St., E.
- Lewiston (Idaho) Country Club—Sec.—Treas., Henry S. Gray; Ch. T.C., Frank W. Kettentbach, Dent & Butler Bldg.
- Litchfield (Conn.) Country Club—Sec., John H. Lancaster; Treas., Cornelius R. Duffie; Ch. T.C., F. Kingsbury Bull.
- Longwood Covered Courts, Chestnut Hills, Mass.—Pres., Edwin Sheafe, 141 Milk St., Boston, Mass.; Sec.—Treas., George S. Baldwin, 27 State St., Boston, Mass.
- Longwood Cricket Club, Boston, Mass.—Sec., Richard Bishop, 157 Sixth St.; Treas., Anson M. Lyman, Pemberton Bldg.; Ch. T.C., N. W. Niles, 52 Devonshire St.
- Maidstone Club, East Hampton, N. Y.—Pres., George E. Munroe, c/o Club; Sec., D. W. McCord, c/o Club; Treas., Theodore W. Morris, Jr., c/o Club.
- Manila Tennis Club, Manila, P. I.—Sec., W. R. Cooley, P. O. Box 725, Manila.
- Mantoloking Yacht Club, Mantoloking, N. J.—Sec., Fisher Lowe Booth; Treas., William B. Simonds.
- Marine and Field Club, Brooklyn, N. Y.—Sec., F. C. Thompson, 20 Exchange Place, New York City; Treas., S. F. Sever, 13 Park Row, New York City; Ch. T.C., C. J. Ranney, c/o Club.
- Meadow Club of Southampton, Southampton, L. I., N. Y.—Sec., Harry P. Robbins, 52 Vanderbilt Ave., New York City; Treas., Alfred E. Schermerhorn, 7 E. 42d St., New York City; Ch. T.C., James P. Lee, 25 Broad St., New York City.
- Merion Cricket Club, Haverford, Pa.—Sec., William W. Montgomery, Jr., c/o Club; Treas., James F. Fahnestock, c/o Club; Ch. T.C., Howard W. Lewis, 421 Chestnut St., Philadelphia, Pa.
- Merriewood (N. Y.) Tennis Club—Sec., Alfred Shriver, 22 Belmont Place, New Brighton, S. I., N. Y.; Ch. T.C., William J. Clarke, 159 W. 59th St., New York City.
- Midwick Country Club, Los Angeles, Cal.—Sec., Russell McD. Taylor, Title Insurance Bldg.; Treas., Hugh Stewart, Farmers and Merchants National Bank; Ch. T.C., Harold O. Ayer, 5 Westmoreland Place, Pasadena, Cal.
- Milford Field Club, Milford, Pike County, Pa.—Sec., Norman Harsell; Treas., Percy Lyman; Ch. T.C., Charles Kenworthy.
- Mohawk Golf Club, Schenectady, N. Y.—Sec., T. A. McLoughlin, 1009 Nott St.; Treas., John Riley, 5 Stratford Road; Ch. T.C., H. H. Gardiner, 116 Waverly Place.
- Montclair (N. J.) Athletic Club—Sec., C. B. Chrystal, 161 Midland Ave.; Treas., F. N. Frye, Bellaire Drive; Ch. T.C., Frederick H. Hovey, 31 Brunswick Road.
- Moorestown (N. J.) Field Club—Sec., William H. Roberts, Jr.; Treas., J. G. Pettitt; Ch. T.C., Edward W. Palmer, 509 Chester Ave.
- Morris County Golf Club, Convent, N. J.—Sec., P. H. B. Frelinghuysen, 32 Liberty St., New York City; Treas., Walter B. Wood, Morristown, N. J.; Ch. T.C., James H. McLean, Morristown, N. J.
- Morristown (N. J.) Field Club—Pres., Charles D. M. Cole, 14 Franklin St.; Sec., Bigelow Watts, Hill St.; Treas., W. J. Romaine, Savings Bank Bldg.
- Mountain Lakes (N. J.) Club—Sec., W. R. Doremus; Treas., C. W. Smith; Ch. T.C., R. W. Seabury, Boonton, N. J.
- Mount Anthony Country Club, Old Bennington, Vt.—Sec.—Treas., Harrie C. White, North Bennington, Vt.; Ch. T.C., George Worthington, Old Bennington, Vt.
- Mount Pleasant Tennis Club, Pleasantville, N. Y.—Sec., Miss Edna Hixon; Treas., Irvin H. Auerbach.
- Mount Washington Club, Baltimore, Md.—Ch. T.C., Thomas S. Ridgway, Fidelity and Deposit Co.
- Multnomah Amateur Athletic Club, Portland, Ore.—Sec., Henry Fischer, c/o Club; Treas., F. W. Camp, c/o Club; Ch. T.C., J. H. Mackie, c/o Club.
- Myopia Hunt Club, Hamilton, Mass.—Sec.—Treas., John A. Blanchard, 262 Washington St., Boston, Mass.; Ch. T.C., J. A. Tuckerman, 44 State St., Boston, Mass.

- Nahant (Mass.) Club—Sec., Charles Boyden, 50 Congress St., Boston, Mass.; Treas., Aaron Davis, 53 State St., Boston, Mass.; Ch. T.C., Frederick Winslow, 275 Clarendon St., Boston, Mass.
- Nassau Country Club, Glen Cove, L. I., N. Y.—Sec.-Ch. T.C., Henry C. Martin, 25 Madison Ave., New York City; Treas., C. D. Smithers, 19 Nassau St., New York City.
- Neighborhood Club, West Newton, Mass.—Sec.-Treas., Francis J. Burrage, 12 Fairfax St.; Ch. T.C., William F. Chase, 34 Temple St.
- New Brunswick (N. J.) Country Club—Sec., A. Wayne Clark, College Ave.; Treas., W. G. Bearman, Georges Road; Ch. T.C., N. G. Rutgers, Jr., 50 Union St.
- New Castle (Pa.) Country Club—Sec., F. W. Farrell Malloy, 803 Highland Ave.; Treas., Rufus McKinley; Ch. T.C., William J. Uber.
- New Dorp Field Club, New Dorp, S. I., N. Y.—Sec., Charles Henderson, 123 Third St.; Treas., Confred W. Barker, Summit Ave.; Ch. T.C., George Morgan, Ross Ave.
- New Haven (Conn.) Lawn Club Association—Sec., Davis L. Daggett, 193 Whitney Ave.; Treas., Brown Hewitt, 193 Whitney Ave.; Ch. T.C., Murray Sargent, 193 Whitney Ave.
- Newport (R. I.) Lawn Tennis Club—Sec., Henry O. Havemeyer, Newport Casino; Treas., F. K. Sturgis, Newport Casino; Ch. T.C., Henry A. C. Taylor, Newport Casino.
- New Rochelle (N. Y.) Tennis Club—Pres., E. J. Hein, 43 Clay St.; Vice-Pres., Cyril West, 39 Dewey Ave.; Sec.-Treas., H. C. Babb, 5 Paine Ave.
- Newton Centre (Mass.) Squash Tennis Club—Sec., E. Ray Speare, 156 Sixth St., Cambridge, Mass.; Treas., Dr. George L. West, 860 Beacon St.; Ch. T.C., George F. Wales, 720 Tremont Bldg., Boston, Mass.
- New York Athletic Club, New York City—Sec., F. R. Fortmeyer, 58 W. 59th St.; Treas., M. S. Paine, 58 W. 59th St.; Ch. T.C., Henry William Wilson, 58 W. 59th St.
- New York Tennis Club, New York City—Sec., Stanley L. Butler, 48 Central Park West; Treas., Louis S. Bailey, 2292 Loring Place; Ch. T.C., J. H. Steinkampf, 596 E. 170th St.
- Niagara Falls (N. Y.) Tennis Club—Sec.-Treas., Robert McDonald, Fifth St.; Ch. T.C., R. Lindley Murray, 211 Fifth St.
- Niagara Lawn Tennis Club, Niagara-on-the-Lake, Canada—Sec., Thomas H. Hall, Continental Life Bldg., Toronto, Can.; Ch. T.C., H. Winnett, Queen's Hotel, Toronto, Can.
- Norfolk (Conn.) Country Club—Sec., Prof. A. L. Frothingham, (Winter) Princeton, N. J.; (Summer) Norfolk; Treas., J. O. Low, 39 Wall St., New York City; Ch. T.C., Edmund W. Peaslee, 17 Washington Square, N., New York City.
- North Hempstead Country Club, Port Washington, L. I., N. Y.—Sec., Ernest M. Strong, 1 W. 34th St., New York City; Treas., F. H. Filley, West and Noble Sts., Brooklyn, N. Y.; Vice-Ch. T.C., Allen Walker, Guaranty Trust Co., 140 Broadway, New York City.
- North Shore Country Club, Glen Head, L. I., N. Y.—Sec., Theodore A. Peyser, 1 Madison Ave., New York City; Treas., M. Kallman, 4 E. 60th St., New York City; Ch. T.C., Arthur A. Kahn, 6 W. 48th St., New York City.
- Norwalk (Conn.) Country Club—Sec., Seymour Carter; Treas., Spencer S. Adams, East Ave.; Ch. T.C., Robert S. Van Buren, 58 West Ave.
- Nyaek (N. Y.) Club—Sec., G. Hilliard Ross; Treas., J. R. Floyd; Ch. T.C., Ralph L. Baldwin, 170 S. Broadway, New York City.
- Oak Tennis Club, Larchmont Manor, N. Y.—Sec., Phil H. Godwin; Treas., Richard Stack.
- Oakley Country Club, Watertown, Mass.—Sec., George W. Cram, Harvard University, Cambridge, Mass.; Treas., William H. Richardson, Equitable Bldg.; Ch. T.C., Alexander Kendall, 15 State St., Boston, Mass.
- Oakwood Country Club, Inc., Lynchburg, Va.—Sec.-Treas., R. A. Owen; Ch. T.C., O. C. Shaner.
- Ocean City (N. J.) Yacht Club—Sec., Harry F. Stanton; Treas., William H. Beaver, 127 N. Fifth St., Philadelphia, Pa.; Ch. T.C., Thomas M. Scott, southeast corner Sixth and Walnut Sts., Philadelphia, Pa.
- Ojai Valley Tennis Club, Ojai, Ventura County, Cal.—Sec., Miss Ethelda Leach, Ojai, Cal.; Treas., J. J. Burke, Ojai, Cal.; Ch. T.C., W. L. Thacher.
- Oklahoma City (Okla.) Golf and Country Club—Sec., George W. Knox, Terminal Bldg.; Ch. T.C., Eugene O. Monnet, Norman, Okla.
- Oldtown Country Club, Newburyport, Mass.—Sec.-Treas., Lawrence P. Dodge, 111 Devonshire St., Boston, Mass.
- Omaha (Neb.) Field Club—Sec., Will R. Wood, 1224 Chicago St.; Treas., C. J. Classon, 1622 Farnam St.; Ch. T.C., Ralph R. Rainey, U. S. National Bank Bldg.
- Onondaga Golf and Country Club, Syracuse, N. Y.—Sec.-Treas., A. C. Stevens, 504 Dillage Block; Ch. T.C., James A. Randall.
- Orange Lawn Tennis Club, South Orange, N. J.—Sec.-Ch. T.C., Allen C. Bragaw, 165 Broadway, New York City; Treas., William M. Van der Kieft, c/o Carter Co., 61 Broadway, New York City.
- Outdoor Club of Pottsville, Pottsville, Pa.—Pres., James Archibald, 1501 Mahantongo St.; Sec.-Treas., B. S. Simonds, 1806 Mahantongo St.
- Overbrook (Pa.) Golf Club—Sec., Robert Y. Bernard, 429 Land Title Bldg., Philadelphia, Pa.; Treas., John T. Dee, 6421 Woodbine Ave., Philadelphia, Pa.; Ch. T.C., H. Eugene Heine, Land Title Bldg., Philadelphia, Pa.

- Palm Beach (Fla.) Tennis Club—Sec., Howard M. Wing, Royal Poinciana, Palm Beach, Fla. (December to May); 243 Fifth Ave., New York City; Ch. T.C., Edwin F. Torrey, P. O. Box 146, Clinton, N. Y.
- Park Club, Buffalo, N. Y.—Sec., Elliot Armstrong, 187 Highland Ave.; Treas., Samuel Ellis 757 Bird Ave.; Ch. T.C., Percival V. Bowen, 936 Ellicott Square.
- Parkersburg (W. Va.) Country Club—Sec.—Treas., B. R. Blackford, Union Trust Bldg.; Ch. T.C., R. A. Johnston, 315 Court Square.
- Passaic (N. J.) Tennis Club—Sec., S. Ira Cooper, 113 Ayerigg Ave.; Treas., H. W. Tooker, 212 Pennington Ave.; Ch. T.C., E. K. Wilcox, 220 Pennington Ave.
- Pelham Country Club, Pelham Manor, N. Y.—Sec., Myron T. Townsend, 52 Broadway, New York City; Treas., Ralph E. Rogers, 2 Rector St., New York City; Ch. T.C., Benjamin F. Briggs.
- Philadelphia and Reading Railway Athletic Association, Philadelphia, Pa.—Sec., H. A. Orf, 710 Reading Terminal; Treas., G. Hanley, Reading Terminal; Ch. T.C., T. Furness, 801 Reading Terminal.
- Philadelphia (Pa.) Country Club—Sec., C. Berkeley Taylor, 904 Land Title Bldg.; Treas., Edward J. Stotesbury, Drexel Bldg.; Ch. T.C., Walter S. Thomson, 121 Chestnut St.
- Philadelphia (Pa.) Cricket Club—Sec., John W. Whittaker, 523 Commercial Trust Bldg.; Treas., Herbert W. Goodall, Guarantee Trust Co., 316 Chestnut St.; Ch. T.C., J. R. Carpenter, 517 Chestnut St.
- Philmont (Pa.) Country Club—Sec., Charles E. Fox, c/o Club; Treas., Ely K. Selig, c/o Club; Ch. T.C., Frank F. Wieder, 2247 Park Ave., Philadelphia, Pa.
- Pinehurst (N. C.) Country Club—Sec.—Treas., Donald J. Ross.
- Piping Rock Club, Locust Valley, L. I., N. Y.—Sec., Frank L. Crocker, 5 Nassau St., New York City; Treas., Frederick P. Moore, 71 Broadway, New York City; Ch. T.C., William A. Greer, 74 Broadway, New York City.
- Pittsburgh (Pa.) Athletic Association—Sec., E. C. Bates, c/o Club; Treas., LaSalle Girts, c/o Club; Ch. T.C., T. C. Ward, Oliver Bldg.
- Pittsburgh (Pa.) Golf Club—Sec.—Treas., F. S. Guthrie, P. O. Box 1013; Ch. T.C., Joseph Dilworth, Fourth and Bingham Sts.
- Plainfield (N. J.) Country Club—Sec., Henry W. Brower, 440 W. Eighth St.; Treas., S. Durrell Lounsbury, 24 Broad St., New York City; Ch. T.C., S. Wallis Merrihew, 120 Broadway, New York City.
- Plymouth Country Club, Norristown, Pa.—Sec.—Treas., Charles T. Larzelere, 320 DeKalb St.; Ch. T.C., Warren L. Irish, The Franklin, Norristown.
- Point Judith Country Club, Narragansett Pier, R. I.—Sec., Rev. P. M. Prescott; Treas., Percy W. Wright, Peace Dale, L. I.; Ch. T.C., S. H. Bird, 127 E. 64th St., New York City.
- Point Pleasant (N. J.) Lawn Tennis Club—Sec., Paul W. Gibbons, 1020 Race St., Philadelphia, Pa.; Ch. T.C., P. S. Osborne, 4610 Old York Road, Philadelphia, Pa.
- Portland Country Club, Falmouth, Me.—Sec., Philip I. Jones, 41 Exchange St., Portland, Me.; Treas., John F. Dana, 57 Exchange St., Portland, Me.; Ch. T.C., Eugene L. Bodge, 120 Exchange St., Portland, Me.
- Powellton Club, Balmville, Newburgh, N. Y.—Sec., N. D. Belknap, Brewster Bldg.; Treas., Dr. P. R. Ashplant, 43 Montgomery St.; Ch. T.C., Henry J. Jova.
- Princeton University, Princeton, N. J.—Capt. T.C., Leonard Beekman, Ivy Club.
- Quincy (Mass.) Tennis Club—Sec., Carl R. Sheppard, 27 Granite St.; Treas.—Ch. T.C., J. Brooks Keyes, 9 Woodward Ave.
- Richmond County Country Club, Dongan Hills, S. I., N. Y.—Sec., Ralph Monell, 14 Wall St., New York City; Treas., Otis A. Glazebrook, Jr., c/o Club; Ch. T.C., Russell H. Loines, 49 Wall St., New York City.
- Ridgewood Club, Columbia, S. C.—Sec.—Treas., A. C. Clarkson, 1433 Main St.; Ch. T.C., W. E. Earl, Jr., Main St.
- Rockaway Hunting Club, Cedarhurst, L. I., N. Y.—Sec., Newbold T. Lawrence, 84 William St., New York City; Treas., Henry S. Parker, 49 Wall St., New York City; Ch. T.C., James A. Hill, 1 Broadway, New York City.
- Rockhill Tennis Club, Kansas City, Mo.—Sec., C. M. Hardenbergh, 701 Dwight Bldg.; Treas., Otto F. Dubach, 3209 E. 30th St.; Ch. T.C., D. Keedy Campbell, c/o Lowe & Campbell, 10th and Grand Sts.
- Roselle (N. J.) Golf Club—Pres., H. R. Benedict, 149 W. Fifth Ave.; Sec., George Vaughan, Jr., Fifth Ave.; Treas., F. E. Nodocker, Fourth Ave. and Locust St.
- Rumson (N. J.) Country Club—Sec., J. Amory Haskell, 19 Cedar St., New York City; Treas., Lester B. Churchill, 91 Liberty St., New York City; Ch. T.C., William B. Potts.
- Rutherford (N. J.) Lawn Tennis Club—Sec., Cosmo Farquhar, Jr., 216 W. Passaic Ave.; Treas., H. E. Booth, c/o Club.
- Sadaquada Golf Club, Utica, N. Y.—Treas., John C. Devereaux, c/o Brennan & Devereaux.
- Salem (Ore.) Tennis Club—Sec., George F. Rodgers, 460 Ferry St.; Treas., Dr. Prince W. Byrd.
- Salt Lake Tennis Club, Salt Lake City, Utah—Sec.—Treas., Leo Eagan, Felt Bldg.; Ch. T.C., George Badger, 160 Main St.

- Saratoga Golf Club, Saratoga Springs, N. Y.—Sec.-Treas., Clarence B. Kilmer, City Hall; (Ch. T.C., George D. Cochran, 720 N. Broadway.
- Scranton (Pa.) Tennis Club—Sec.-Treas., A. G. Sloat, 1326 Linden St.; Ch. T.C., W. M. Curry, 827 Connell Bldg.
- Seabright (N. J.) Lawn Tennis and Cricket Club—Sec., George W. Bodman, 15 Wall St., New York City; Treas., H. T. Riker, c/o Club.
- Seattle (Wash.) Tennis Club—Sec., Crawford Anderson; Treas., E. W. Brownell, National Bank of Commerce.
- Sedgwick Farm Club, Syracuse, N. Y.—Sec.-Treas., H. H. Wadsworth, 412 Dewitt St.; Ch. T.C., S. F. Raleigh, 412 Dewitt St.
- Seventh Regiment Tennis Club, New York City—Sec., W. Dickson Cunningham, 253 W. 99th St.; Treas., T. A. Bruno, 52 Vanderbilt Ave.; Ch. T.C., A. C. Postley, 453 Greenwich St.
- Shawnee Country Club, Shawnee-on-Delaware, Pa.—Sec., R. S. Worthington; Treas., E. M. Sawtelle, 147 W. 49th St., New York City; Ch. T.C., C. C. Worthington.
- Short Hills (N. J.) Club—Sec., F. W. Jefferson; Treas., James W. Strong; Ch. T.C., H. S. Foote.
- Sioux City (Iowa) Lawn Tennis Association—Sec.-Treas., E. C. Lidster, 406 Pierce St.; Ch. T.C., E. L. Isaacson, 429 Frances Bldg.
- Sippican Tennis Club, Marion, Mass.—Sec.-Treas., Herbert Austin, 102 North St., Boston, Mass.
- Sleepy Hollow Country Club, Scarborough-on-Hudson, N. Y.—Sec., Franklin A. Plummer, 71 Broadway, New York City; Treas., Edward W. Harden, 36 Wall St., New York City; Ch. T.C., Kenneth Ives, 7 E. 42d St., New York City.
- Spokane (Wash.) Tennis Club—Sec., W. H. Farnham, 1305 Old National Bank Bldg.
- Springhaven Club, Wallingford, Pa.—Sec., John C. Taney, Ardmore, Pa.; Treas., J. R. Kerr, Moylan, Pa.; Ch. T.C., S. I. Irving, Irvington, Chester, Pa.
- Squirrel Island (Me.) Athletic Association—Sec.-Treas., David M. Young, Sangerville, Me.; Ch. T.C., Edward H. Bonelli, 60 State St., Boston, Mass.
- Stamford (Conn.) Yacht Club—Sec., Col. Robert H. Patterson, Verplank Ave., Shippon Point; Treas., E. E. Seoville, Verplank Ave., Shippon Point; Ch. T.C., Francis C. Hoyt, Ocean Drive West, Shippon Point.
- Stanton Heights Golf Club, Pittsburgh, Pa.—Sec., Bruce D. Miller, 246 Third Ave.; Treas., Grant Debert, Stanton and Candless Ave.; Ch. T.C., R. C. Bovard, 915 Jancey St.
- Staten Island Cricket and Tennis Club, Livingston, West New Brighton P. O., N. Y.—Sec., H. G. Van Vechter; Treas., R. St. G. Walker, 64 Beaver St., New York City; Ch. T.C., John D. Ogilby, c/o Club.
- Staten Island Ladies' Club, West New Brighton, S. I., N. Y.—Sec., Miss Dorothy Wemple, Henderson Ave.; Treas., Mrs. Grosvenor Wright, St. Marks Place; Ch. T.C., Miss Abby Boody, Henderson Ave.
- Stenton Athletic Club, Philadelphia, Pa.—Sec., W. E. D. Reeves, 703 Walnut St.; Treas., Ralph Moyan, 29th and Dauphin Sts.; Ch. T.C., Hosmer W. Hanna, 13th and Sansom Sts.
- Sterling Tennis Club, Brooklyn, N. Y.—Sec.-Treas., C. N. Fleming, 241 Brooklyn Ave.
- Stockbridge (Mass.) Golf Club—Sec., Phillips Biagden; Treas., Frank E. Coursen; Ch. T.C., Mrs. E. T. Rice.
- St. Petersburg (Fla.) Tennis Club—Ch. T.C., Walter P. Fuller.
- St. Louis (Mo.) Amateur Athletic Association—Sec.-Treas., Morris J. Halloran, 317 Security Bldg.; Ch. T.C., Roland M. Hoerr, 705 Olive St.
- Sunningdale Country Club, Inc., Mt. Vernon, N. Y.—Sec., K. Richard Wallach, 44 Cedar St., New York City; Treas., Maurice Brill, 1619 Broadway, New York City; Ch. T.C., L. Albert Sarnstg.
- Swimming Club, Bar Harbor, Me.—Sec.-Treas., Stroud Rodiek; Ch. T.C., William Lawrence Green, 405 Park Ave., New York City.
- Tacoma (Wash.) Lawn Tennis Club—Treas., Ralph S. Stacy, National Bank of Commerce; Ch. T.C., Miss Jessie Kershaw, 419 N. I St.
- Talbot Country Club, Easton, Md.—Sec., S. A. Rohrer; Treas., J. M. Elliott; Ch. T.C., Rev. Henry Davies.
- Tennis Club of Rochester, Rochester, N. Y.—Sec.-Treas., Henry H. Stebbins, Jr., 87 Franklin St.; Ch. T.C., Arthur B. Headley, 302 Carter Bldg.
- Terrace Club of Flatbush, Brooklyn, N. Y.—Sec.-Treas., LeRoy Morand, c/o Harriman & Co., 111 Broadway, New York City; Ch. T.C., Royal D. Richey, 313 Park Place.
- Thousand Islands Country Club, Alexandria Bay, N. Y.—Pres., Charles S. Rees; Sec.-Treas., C. L. Hayden.
- Toledo (Ohio) Tennis Club—Pres., O. B. Snider, Nicholas Bldg.
- Toy Town Tennis Club, Winchendon, Mass.—Sec.-Treas., James A. Boyce, Toy Town Tavern; Ch. T.C., Louis Slidge, Toy Town Tavern.
- Tuxedo Club, Tuxedo Park, N. Y.—Hon. Pres., Pierre Lorillard, c/o Club; Sec., Paul Tuckerman, c/o Club; Treas., Joseph Earle Stevens, c/o Club.
- United Shoe Machinery Athletic Association, Beverly, Mass.—Sec.-Treas., Henry A. Lindgren, 38 Union St.; Ch. T.C., Henry L. Bell, 19 Federal St.

- University Heights Tennis Club, New York City—Sec.-Ch. T.C., J. W. Mersereau, 2452 De Voë Terrace; Treas., W. M. Fisher, 550 W. 172d St.
- University of Pennsylvania Tennis Association, Philadelphia, Pa.—Address J. Louis Wenzel, Manager.
- Utica (N. Y.) Golf and Country Club—Sec., Richard E. Hatfield, c/o Walcott & Campbell Spin Co., New York Mills, N. Y.; Treas., Sylvester B. French, c/o Citizens Trust Co.; Ch. T.C., D. Carrol Porter, 1921 Holland Ave.
- Vesper Country Club, Tyngsborough, Mass.—Sec., Andrew G. Swapp, P. O. Box 977, Lowell, Mass.; Treas., Arthur J. Murkland, 58 Central St., Lowell, Mass.; Ch. T.C., H. Hutchins Parker, Dutton St., Lowell, Mass.
- Virginia Hot Springs Golf and Tennis Club, Hot Springs, Va.—Sec.-Treas., A. E. Emerson; Ch. T.C., S. Wallis Merrilow, 120 Broadway New York City.
- Vedado Tennis Club, Havana, Cuba—Sec., Armando Rosales, Armargura 23; Treas., Antonio G. Suarez, Obrabia 35; Ch. T.C., Manuel Gamba, Habana 55.
- Wannamoissett Country Club, Rumford, R. I.—Sec., Edward S. White, Box 1115, Providence, R. I.; Treas., Edwin A. Johnson, Box 1115, Providence, R. I.; Ch. T. C., Elliot G. Parkhurst, 170 Westminster St., Providence, R. I.
- Waverly Country Club, Portland, Ore.—Sec., Irving Webster, Gasco Bldg.; Treas., A. E. Doyle, Worcester Bldg.; Ch. T.C., Ralph Wilbur, Board of Trade Bldg.
- Wee Burn Golf Club, Noroton, Conn.—Sec.-Treas., R. J. Sanderson; Ch. T.C., Dr. Harold R. Mixsell, 134 E. 76th St., New York City.
- Wellesley Country Club, Wellesley Hills, Mass.—Sec., Chester G. Clark; Treas., W. L. Burchstead.
- Wentworth Lawn Tennis Club, New Castle, N. H.—Pres., Andrew Myrick, 43 Botolph St., Melrose, Mass.; Sec., George E. Cooley, Stuyvesant High School, New York City; Treas., C. A. Judkins.
- Western Michigan Tennis Association, Grand Rapids, Mich.—Sec.-Ch. T.C., Charles W. Boltwood, 605 Michigan Trust Co. Bldg.; Treas., Carroll H. Perkins, Michigan Trust Co. Bldg.
- Westfield (N. J.) Golf Club—Sec., Paul B. Scarff, 35 Nassau St., New York City; Treas., C. P. Worth, 24 Walnut St.; Ch. T.C., Fred G. Smith, Boulevard.
- Westfield (N. J.) Tennis Club—Sec., C. H. Warfield, 123 Harrison Ave. West; Treas., L. E. Glover, 715 Standish Ave.; Ch. T.C., E. R. Merry, Jr., 618 Arlington Ave.
- Westmont Tennis Club, Johnstown, Pa.—Sec.-Treas., R. S. Reilly, 244 Tioga St.; Ch. T.C., H. S. Tinker, Venango St.
- West Side Tennis Club, Forest Hills, L. I., N. Y.—Sec., William Alex. Campbell, 2 Rector St., New York City; Treas., Hugh C. Guiler, 82 Beaver St., New York City; Ch. T.C., S. J. Gallon, 23 Thomas St., New York.
- Wilmington (Del.) Country Club—Sec., Frank H. Janview, Ford Bldg.; Treas., Caleb M. Steward, c/o Wilmington Trust Co.; Ch. T.C., Thomas W. Harris, Jr., 7132 Du Pont Bldg.
- Winchester (Mass.) Country Club—Sec., James Nowell; Treas., Joseph Barton; Ch. T.C., George G. Tarbell.
- Wissahickon Tennis Club, Philadelphia, Pa.—Sec., Kenneth Snyder, 302 Rochelle Ave.; Treas., Henry L. Bartle, 519 Jamestown Ave., Roxboro, Pa.
- Wollaston (Mass.) Tennis Club—Sec., Jesse L. Litchfield, Arlington St.; Treas., H. H. Albee, 377 Highland Ave.; Ch. T.C., Clarence Hutton, Prospect Ave.
- Women's Tennis Club of Western Pennsylvania, Pittsburgh, Pa.—Sec., Mrs. H. J. Miller, 5 Von Lent Place; Treas., Mrs. Felix Snowden, 5030 Fifth Ave.; Ch. T.C., Miss E. L. C. Weimer, 525 Jones Ave., Braddock, Pa.
- Women's Tennis League of District of Columbia, Washington, D. C.—Pres., Miss Maude Sewall, The Northumberland; Sec.-Treas., Miss Rebecca Laurens Love, 3748 McKinley St.
- Woodbury (N. J.) Country Club—Sec., Joseph J. Summerville, Jr.; Treas., William H. Sutton; Ch. T.C., Frederick Norck, Broad St.
- Woodmere Club, Woodmere, L. I., N. Y.—Sec., Louis Tumpson, 53 W. 23d St., New York City; Treas., David Anshacher, 527 Fifth Ave., New York City; Ch. T.C., Leslie H. Fishel, 126 W. 22d St., New York City.
- Woodway Country Club, Inc., Stamford, Conn.—Pres., Theodore R. Hoyt, 17 Battery Place, New York City; Sec., George M. Skene, 303 Main St.; Treas., William N. Travis, Stamford National Bank.
- Worcester (Mass.) Tennis Club—Sec., Harry H. Atwood, Court House; Treas., W. Parker Delano, Jr., 44 Front St.; Ch. T.C., Rockwood H. Bullock, 311 Main St.
- Wyoming Valley Country Club, Wilkes-Barre, Pa.—Sec.-Treas., Edmund E. Jones, 704 Miners Bank Bldg.; Ch. T.C., G. Fred Parrish, 704 Miners Bank Bldg.
- Yahnundasis Golf Club, Utica, N. Y.—Sec., Fredrick W. Owen, 113 Liberty St.; Treas., Douglass M. Ross, City National Bank Bldg.; Ch. T.C., Edwin Fuller Torrey, P. O. Box 146, Clinton, N. Y.
- Yale University Tennis Association, New Haven, Conn.—Sec., E. L. Hopkins; Capt., Charles S. Garland, 1422 Malo Station.

## ASSOCIATIONS BELONGING TO THE U. S. N. L. T. A.

**BORDER STATES TENNIS ASSOCIATION**—Sec.-Treas., William H. Webster, Douglas, Ariz.

## MEMBERS.

Albuquerque (N. M.) Tennis Club.  
 Coñri Valley Country Club, Globe, Ariz.—Sec., J. A. Todd, c/o Club.  
 Clifton (Ariz.) Tennis Club—Sec., Norman Carmichael, c/o Club.  
 Dawson (N. M.) Country Club—Sec., T. H. O'Brien.  
 Douglas (Ariz.) Country Club—Sec.-Treas., H. J. Bishop; Ch. T.C., A. B. Packard.  
 El Paso (Tex.) Smelter Club—Sec., N. A. Ferguson, c/o Club.  
 El Paso (Tex.) Country Club—Sec., E. E. Neff, c/o Club.  
 Las Cruces (N. M.) Tennis Club.  
 Metcalf (Ariz.) Tennis Club.  
 Morenci (Ariz.) Tennis Club—Sec., C. B. Mackreth, c/o Club.  
 Nacorazi Country Club, Nacorazi, Son., Mexico—Sec., J. S. Williams, Jr., c/o Club.  
 Pecos (Tex.) Country Club.  
 Phoenix (Ariz.) Country Club—Sec., Dwight B. Heard, c/o Club.  
 Roswell (N. M.) Tennis Association—Sec., B. H. Bassett, c/o Club.  
 Tucson (Ariz.) Golf and Country Club—Sec., J. M. Lawton, c/o Club.  
 University of Arizona Tucson, Ariz.  
 Warren Country Club, Bisbee, Ariz.—Sec., G. H. Dowell, c/o Club.

**CALIFORNIA LAWN TENNIS ASSOCIATION**—Pres., Dr. Sumner Hardy, 209 Post St., San Francisco; Sec., J. C. Pohlfs, Marine Dept., Standard Oil Bldg., San Francisco; Treas., S. R. Marvin, 21 California St., San Francisco.

## MEMBERS.

Alameda Tennis Club—Sec., Winthrop Branchid, 3001 Central Ave.  
 Bellevue Tennis Club of Alameda—Sec., McKee Sherrard, 525 Sansome St., San Francisco.  
 Berkeley Tennis Club—Pres., Wallace Alexander, Alaska Commercial Bldg.; Sec., Frederick Whitton, 369 Pine St., San Francisco.  
 Boys' Golden Gate Park Tennis Club—Sec., Herbert Suhr, 999 Duboce Ave., San Francisco.  
 California Lawn Tennis Club—Sec., H. B. Richardson, Bush and Scott Sts., San Francisco.  
 Claremont Country Club—Sec., C. H. Singleton, Broadway and Clifton, Oakland.  
 Girls' (Junior) Golden Gate Park Tennis Club—Pres., Emelia Sherwood, 976 Broadway, San Francisco.  
 Hillside Tennis Club—Sec., H. N. Storrs, 75 Miller Ave., Sausalita.  
 Island City Tennis Club of Alameda—E. G. Cook, 606 Lincoln Ave., Alameda.  
 Lagunitas Country Club—Pres., S. H. Derby, Merchants Exchange Bldg., San Francisco.  
 Marin Golf and Country Club—Sec., R. J. Davis, 54 Natoma St., San Francisco.  
 Men's Gold Gate Park Tennis Club—Edw. A. Zeisler, 701 Market St., San Francisco.  
 Naglee Park Tennis Club—W. E. Jackson, 140 S. 15th St., San Jose.  
 Oakland Tennis Club—E. M. Otis, Merchants Exchange Bldg., San Francisco.  
 Ojai Valley Tennis Club—Pres., W. L. Thacher, Ojai.  
 Piedmont Tennis Club—Wickham Havens, Realty Syndicate Bldg., Sacramento.  
 Sacramento Tennis Club—J. I. Brunschweiler, 914 30th St., Sacramento.  
 Women's Golden Gate Park Tennis Club—Mrs. S. H. Fletcher, 169 Collingwood St., San Francisco.

## SOUTHERN CLUBS OF C.L.T.A.

Los Angeles Country Club—Sec., C. A. Holden, Beverly Hill.  
 Southern California Tennis Club—Nat Browne, 432 Pacific Electric Bldg., Los Angeles.  
 Estrella Tennis Club—H. H. Belden, 310 S. Van Ness Ave., Los Angeles.  
 Midwick Country Club—Nat Browne, 432 Pacific Electric Bldg., Los Angeles.  
 Santa Monica Tennis Club—Nat Browne, 432 Pacific Electric Bldg., Los Angeles.  
 San Gabriel Valley Country Club—Nat Browne, 432 Pacific Electric Bldg., Los Angeles.

**CLEVELAND ASSOCIATED TENNIS CLUBS**, Cleveland, Ohio—Pres., B. F. Thorward, National Lamp Works, Nela Park; Sec., F. W. Wagner, c/o Forman-Bassett Co.; Treas., E. C. Hay, Cleveland Electric Illuminating Co.

**HUDSON RIVER LAWN TENNIS ASSOCIATION**—Pres., Homer L. Guernsey, c/o Poughkeepsie Lawn Tennis Club, Poughkeepsie, N. Y.; Sec.-Treas., H. W. Forster, 248 Van Cortland Park Ave., Park Hill, Yonkers, N. Y.

**INDIANA LAWN TENNIS ASSOCIATION**—Sec., J. Lloyd Wayne, 3d, P. O. Box 408, Indianapolis, Ind.

## MEMBERS.

Indianapolis Lawn Tennis Association—Pres., J. Lloyd Wayne, 3d, P. O. Box 408; Sec., Walter R. Mayer, 36 S. Meridian St.  
 Fort Wayne Country Club—Sec., Arthur F. Hall, Lincoln National Life Insurance Co.  
 Indianapolis Country Club—Ch. T.C., Garvin Brown.  
 Woodstock Club, Indianapolis—Ch. T.C., Mrs. Willis Adams.



**INTERCOLLEGIATE LAWN TENNIS ASSOCIATION**—Sec., Charles S. Garland, 1432 Yale Station, New Haven, Conn.; Treas., Leonard Beekman, Ivy Club, Princeton, N. J.

## MEMBERS.

Cornell University, Ithaca, N. Y.—Manager Tennis Team, P. L. Bleakley.  
 Dartmouth College, Hanover, N. H.  
 Harvard University, Cambridge, Mass.—Manager Tennis Team, E. C. Hodges.  
 Princeton (N. J.) University—Manager Tennis Team, Leonard Beekman.  
 University of Pennsylvania, Philadelphia, Pa.—Manager Tennis Team, J. Louis Wenzel.  
 Yale University, New Haven, Conn.—Manager Tennis Team, Charles S. Garland, 1432 Yale Station.

**KENTUCKY LAWN TENNIS ASSOCIATION**—Pres., Harry J. Lyons, Kenyon Bldg., Louisville; Sec.-Treas., C. S. Bixby, 325 Paul Jones Bldg., Louisville.

**NEW ENGLAND INTERCOLLEGIATE LAWN TENNIS ASSOCIATION**—Pres., Milton M. McGorriil, Brunswick, Me.; Vice-Pres., Thomas G. Kimball, Williamstown, Mass.; Sec.-Treas., E. H. Hendrickson, Amherst, Mass.

## MEMBERS.

Amherst College, Amherst, Mass.  
 Bates College, Lewiston, Me.  
 Bowdoin College, Brunswick, Me.  
 Brown University, Providence, R. I.  
 Dartmouth College, Hanover, N. H.  
 Massachusetts Institute of Technology, Cambridge, Mass.  
 Trinity College, Hartford, Conn.  
 Tufts College, Medford, Mass.  
 Wesleyan University, Middletown, Conn.  
 Williams College, Williamstown, Mass.  
 (Address, in each case, Manager of Tennis.)

**ORTHWESTERN LAWN TENNIS ASSOCIATION**—Sec., J. W. Adams, Plymouth Bldg., Minneapolis, Minn.

**OHIO LAWN TENNIS ASSOCIATION**, Cincinnati, Ohio—Sec., A. F. Zimmerman, Pearl and Walnut Sts.; Treas., H. H. Bates, 35 Atlas Bank Bldg.; Ch. T.C., William H. Hopple, Walsh Bldg.

## MEMBERS.

Cincinnati Tennis Club, Cincinnati.  
 Hyde Park Tennis Club, Cincinnati.  
 Norwood Tennis Club.

**SOUTHERN LAWN TENNIS ASSOCIATION**—Pres., Esmond Phelps, 708 Union St., New Orleans, La.; Vice-Pres., Leroy Cooper, c/o J. S. Rollard & Co., Memphis, Tenn.; Sec.-Treas., Carleton Y. Smith, 608 Walton Bldg., Atlanta, Ga.

## MEMBERS.

Asheville (S. C.) Country Club—Ch. T.C., Stanley Howland, c/o Club.  
 Atlanta (Ga.) Athletic Club—Ch. T.C., C. Y. Smith, 608 Walton Bldg.  
 Atlanta (Ga.) Parks Association—Sec., Dave Gillespie, City Hall.  
 Augusta (Ga.) Country Club—Sec., M. D. Ridgeley, c/o Club.  
 Birmingham (Ala.) Country Club—Sec.-Treas., L. F. Dienna, c/o Club.  
 Birmingham (Ala.) Y.M.C.A.—Treas., B. W. Ewing, c/o Club.  
 Cascade Tennis Club, Atlanta, Ga.—Sec., J. W. Cooper, 121 Auburn Ave.  
 Charlotte (N. C.) Country Club—Treas., D. D. Traywick, c/o Club.  
 Chattanooga (Tenn.) Golf and Country Club—Sec., R. L. Chandler, c/o Club.  
 Knoxville (Tenn.) Tennis Club—Sec., Charles M. Rodgers.  
 Memphis (Tenn.) Country Club—Sec., S. E. Ellison, c/o Club.  
 Mountain Club, Lookout Mountain, Chattanooga, Tenn.  
 New Memphis Tennis Club, Memphis, Tenn.—Sec., F. B. Smithwick, Box 12.  
 New Orleans (La.) Country Club—Sec., Charles B. Thorn, 209 Varieties Place.  
 New Orleans (La.) Lawn Tennis Club—Sec.-Treas., George W. Robertson, Room 219, Post Office Bldg.; Ch. T.C., Rush P. Strong, 438 Varonne St.  
 Nolton Country Club, Nashville, Tenn.—Sec.-Treas., S. C. Henry, c/o Club.  
 Sans Souci Country Club, Greenville, S. C.—Sec.-Treas., Marion Brawley, Charlotte, N. C.  
 Savannah (Ga.) Golf Club—Ch. T.C., Lester Karow, c/o Club.  
 Tulane Athletic Association, Tulane University, New Orleans, La.—Send mail to Association.

**TEXAS LAWN TENNIS ASSOCIATION**—Pres., Prof. Daniel A. Penick, University of Texas, Austin, Tex.; Sec., L. H. Dunn.

**WESTCHESTER COUNTY LAWN TENNIS ASSOCIATION**—Sec., Stuart H. Rowe, 10 Hillcrest Ave., Park Hill, Yonkers, N. Y.

**WESTERN LAWN TENNIS ASSOCIATION**, Chicago, Ill.—Pres., L. H. Waidner, 175 W. Jackson Blvd.; Sec., J. C. Stewart, 150 E. Superior St.; Treas., R. F. Woods, 38 E. Dearborn St. Send mail for all officers to 1510 First National Bank Bldg.

## MEMBERS.

**Chicago Tennis Association**, Chicago, Ill.—Pres., R. L. Van Arsdale, South Side Tennis Club; Sec., Wilbur Jackson, Minocqua; Treas., L. R. Hayes, South Side Tennis Club.  
**Omaha (Neb.) Field Club**—Sec., William R. Wood, 1224 Chicago St.; Treas., C. J. Clausen, 1622 Farnam St.; Ch. T.C., Ralph R. Rainey, U. S. National Bank Bldg.

## PARK ASSOCIATIONS BELONGING TO THE U. S. N. L. T. A.

**Atlanta Parks Association**, Atlanta, Ga.—Sec., C. Y. Smith, 608 Walton Bldg.  
**Harrisburg (Pa.) Park Tennis Association**—Vice-Pres., Charles E. Dasher, 35 Union Trust Bldg.

**Interpark Tennis Association**, Baltimore, Md.—Sec.-Treas., Frederick Spuck, Southern Electric Co.

**Municipal Athletic Association**, St. Louis, Mo.—Ch., Rodowe H. Abeken, 330 Municipal Courts Bldg.

**Playground and Recreation Commission**, Fresno, Cal.—Supt., Raymond L. Quigley.  
**Public Courts Playground Association**, Kansas City, Mo.—Sec., M. D. Waltner, 504 Ridge Arcade.

**Public Parks Lawn Tennis Association**, New York City—Sec., J. J. McDonagh, 71 Broadway; Treas., S. L. Rynar; Ch. T.C., J. P. Allen, 44 Pine St.

**Public Schools Athletic League**, New York City—Sec., C. Ward Crampton, 157 E. 67th St.; Treas., S. R. Guggenheim, 120 Broadway; Ch. T.C., Rowland A. Patterson, 157 E. 67th St.

**Public Parks Lawn Tennis Association**, Stamford, Conn.—Clerk, George P. Rowell.  
**Recreational Parks Tennis Association**, Detroit, Mich.—Sec., Vincent P. Dacey, 818 Farwell Bldg.; Ch. T.C., G. F. Ashe, 818 Farwell Bldg.

**Westchester County Y.M.C.A.**, Pleasantville, N. Y.—Sec., George W. Oakley, Jr.; Treas., S. Wood Cornell; Ch., William Sloane.

# Regulations for the International Lawn Tennis Association Davis Cup

Revised and Adopted by the United States, Great Britain, France, Belgium,  
Austria and Australia, 1906.

1. The competition shall be called "The International Lawn Tennis Championship," and shall be open to any nation which has a recognized Lawn Tennis Association or Corresponding Organization; and, for the purposes of the Regulations, Australia, with New Zealand, the British Isles, British South Africa, Canada, India, Sweden and Norway, and the United States of America shall, amongst others, be regarded as separate Nations.

2. The Nation for the time being holding the International Lawn Tennis Championship shall hereinafter be termed "The Champion Nation."

3. The Competition shall take place in accordance with the following regulations, and, except in so far as may be agreed upon by the competing Nations for their own Tie, with the Laws and Regulations of the game for the time being sanctioned by the Champion Nation.

4. The management of the Competition shall be entrusted to a Committee, hereafter termed "The Committee of Management," which shall be appointed annually by the Lawn Tennis Association or Corresponding Organization of the Champion Nation.

5. The Committee of Management shall make all arrangements for the preliminary Tie or Ties (if any) of the Competition where such preliminary Tie or Ties are to be played in the Country of the Champion Nation, and also for the Challenge Tie, and its decision in respect of all such arrangements shall be final. The Committee of Management shall also have power to depute to others, in any preliminary Tie or Ties, the making of all or any such arrangements as may be deemed necessary.

6. Any Nation wishing to compete shall give notice to the Secretary of the Lawn Tennis Association or Corresponding Organization of the Champion Nation, so that it shall reach him not later than the first Monday in March of the year, in which the Competition is to take place. Should more than one Nation challenge, they shall compete among themselves for the right to play the Champion Nation in the Challenge Tie. The Draw, at which each Challenging Nation may be represented, shall be made by the Committee of Management on the day following the first Monday in March, and particulars shall be notified to the respective Secretaries for the time being of the Lawn Tennis Associations or Corresponding Organizations of the several competing Nations, with an intimation of the latest date by which the Tie or Ties shall be concluded. Failure to conclude a Tie by the date fixed by the Committee of Management shall render both Sides liable to be scratched, unless in the opinion of the Committee of Management, the weather or other unavoidable hindrance, shall have made completion impossible. Competing Nations shall arrange among themselves for the playing of their respective Ties upon a ground or grounds, and upon a date or dates convenient to those concerned; but, in the event of an agreement not being arrived at, the preliminary Tie or

Ties shall be played in the country of the Champion Nation upon a ground or grounds, and upon a date or dates, to be fixed upon by the Committee of Management.

7. When gate money shall be taken, one half of the profit shall belong to the visiting Nation; or, in the case of a Tie being played on neutral ground, one third each to the visiting Nations, and the remaining fraction of profit in each case shall go to the Nation in whose Country the Tie shall be played.

8. The Challenge Tie shall be played in the country of the Champion Nation at a date and upon a ground to be agreed upon by common consent. In the event of an agreement not being arrived at, the fixing of the date and ground shall be submitted to Arbitration.

9. A player shall be qualified to represent a Nation, if he shall have been born in that Nation, or shall have resided therein for at least two years immediately preceding a Tie, provided always that he be a *bona fide* Amateur; but, no one shall be entitled to play for more than one Nation in this Competition during the same year. During the time that a player may be qualifying to play for a Nation under the residential qualifications, he may play for the Nation for which he shall have been last previously qualified.

10. The Lawn Tennis Association or Corresponding Organization of each of the Nations concerned shall appoint a Captain of its Side. In default of such appointment a Side shall choose its own Captain.

11. For each Tie a Referee, from whose decision there shall be no appeal, shall be appointed by common consent of the Captains of the competing Sides. He shall have power to appoint Umpires. He shall decide any point of law which an Umpire may profess himself unable to decide, or which may be referred to him on appeal from the decision of an Umpire by the players. He shall decide, if he be called upon to decide by the Captain of either Side, whether or not a Match or Matches shall be stopped owing to the state of the courts, the state of the weather, darkness, or other unavoidable hindrance.

12. (a) Each competing Nation shall, twenty-one days before the date fixed for the commencement of a Tie, nominate to the Committee of Management not more than four players, without specifying who shall play in Singles and Doubles. Different players, however, may be nominated by a Nation for different Ties.

(b) Each Captain shall, twenty-four hours before the time fixed for the commencement of play in each Contest, give notice of the composition of his Team to the Executive Committee, and his Team shall be selected from the four players previously nominated for the Tie. Such selection by the Captain, however, shall be regarded as solely for the convenience of the Executive Committee, and may be varied by him before the commencement of play.

(c) For the Second Round of the Singles Contest in any Tie, the Referee may sanction the substitution of another of the players nominated by a Nation for that Tie in the place of any player, who, in the opinion of the Referee, is incapacitated by illness, accident or other unavoidable hindrance; provided that such substitute shall not be the player who has already competed in the Singles Contest.

13. The time of cessation of play shall be fixed before the commencement of each day's play by the Captains of the opposing Sides, or by the Referee if they shall disagree. It shall be the duty of the Referee to stop play when this time arrives; provided, nevertheless, that he may extend the time with the consent of the Captains of the opposing Sides. A player shall not be called upon to play more than one Match a day, except with the unanimous consent of the Captains of the opposing Sides and the majority of the Executive Committee.

14. Each Tie shall be decided by the combined results of Singles and Doubles, and the Side which shall win the majority of Matches shall be the winner of a Tie.

15. In the Singles, each Team shall, subject to Regulation 12, Clause c, consist of two players, who shall play each against each of the opposing Team the best of five advantage sets. The order of play and courts shall be decided by lot. In the Doubles, each Team shall consist of two players, who shall play against the opposing Team the best of five advantage sets.

16. Unless otherwise arranged by the unanimous consent of the Captains of the opposing Sides and the majority of the Executive Committee, the Doubles shall take place between the two rounds of the Singles Contest. If, however, a player be chosen for both the Singles and Doubles Contests, and if, by a change in the above arrangements, he be called upon to play his two Singles Matches on consecutive days, then there shall be an interval of one day between the second and the third day's play. Provided, nevertheless, that if there be an interval between the first and second day's play, either from postponement, arrangement, or the interval of a Sunday, there shall not be an interval between the second and third day's play.

17. If any player be absent when called upon to play by the Referee, the opposing Side shall be entitled to three love sets.

18. Any Competing Nation whose Lawn Tennis Association or Corresponding Organization, or whose Representatives shall fail to conform to the above Regulations, may be disqualified by the Committee of Management in respect of the Competition for the year wherein such failure shall occur.

19. Winners of a preliminary Tie shall notify the result without delay to the Committee of Management, by telegram, which shall be confirmed by letter.

20. For purposes of correspondence and the giving of notices required by these Regulations, the Secretary for the time being of the Lawn Tennis Association or Corresponding Organization of the Champion Nation shall be regarded as representing the Committee of Management.

21. The above Regulations shall be binding upon the Nations concerned, and shall not be altered except with the consent of two-thirds of the Associations or Corresponding Organizations whose Nations shall have from time to time competed and who shall record their votes.

NOTE.—In the above Regulations, one Nation playing against another is regarded as a "Tie"; Singles and Doubles are regarded as separate "Contests"; and the best of five advantage sets is regarded as a "Match". The players in Singles and Doubles are regarded as separate "Teams"; and the players in the combined Contests as a "Side".



EDWARD C. CONLIN,  
New York.  
Chairman National Umpires' Association.

### PART III

# Laws of Lawn Tennis

With Explanations by Edward C. Conlin,  
Chairman National Umpires' Association,  
and Supplemented by Cases and Decisions  
Recognized by the United States National  
Lawn Tennis Association.

Special Chapters on

• **Duties of the Referee**

**Umpiring and Line Umpiring**

**Lawn Tennis Etiquette**

By Edward C. Conlin

| CONTENTS.  |  | Page |
|--|--|------|
| Duties of the Referee.....                         |  | 247  |
| Umpire and Linesmen's Diagram.....                 |  | 248  |
| Umpiring and Line Umpiring.....                    |  | 249  |
| Facsimile of Officials' Card.....                  |  | 250  |
| Lawn Tennis Etiquette.....                         |  | 255  |
| Regulations for the Management of Tournaments..... |  | 258  |
| Odds .....   |  | 268  |
| Instructions for Handicapping.....                 |  | 269  |
| How to Conduct a Tournament.....                   |  | 270  |
| Deed of Gift Form for Challenge Cups.....          |  | 271  |
| Simple Method of Making the Draw.....              |  | 272  |
| Schedule for a Round Robin Tournament.....         |  | 273  |
| Laws of Lawn Tennis.....                           |  | 275  |
| How to Lay Out a Tennis Court.....                 |  | 302  |
| How to Build and Keep a Court.....                 |  | 303  |

For a number of years there has seemed to me to be a great need for an explanation of the Laws of Lawn Tennis that would make them easily understood by all who play or follow the game and tend to bring about a uniform application of the rules.

The instructions for officials and players naturally followed.

A compilation of this kind had to come in lawn tennis. This is the first attempt—and this is a perfecting age.

Much of the material used in compiling these explanations and instructions has been taken from American Lawn Tennis. President George T. Adee of the United States National Lawn Tennis Association, Raymond D. Little and Paul B. Williams also have been of great assistance, and my thanks are extended to them.

E. C. CONLIN,  
Chairman National Umpires' Association.



## Duties of the Referee

BY EDWARD C. CONLIN, CHAIRMAN NATIONAL UMPIRES' ASSOCIATION.

(Copyright, 1919, by American Sports Publishing Company.)

The tournament committee elects the referee.

His name shall appear on the circular giving the conditions of the competition, issued by the committee.

He has the power to appoint a substitute who is approved by the tournament committee.

The referee or his substitute must be present at all times when play is in progress.

The referee cannot umpire a match unless he appoints a substitute referee.

He has the power to appoint umpires and linesmen.

He has the power to assign courts.

He has the power to start matches.

He has the sole power to excuse a competitor from playing for a definite period.

The referee shall decide any point of law which an umpire may profess himself unable to decide, or which may be referred to him on appeal from the decision of an umpire, and such decision shall be final.

The referee shall, during the tournament, be ex-officio member of the committee.

The committee shall help to keep order on the ground, and shall consult and decide upon any question arising out of the competition, if summoned for that purpose by the referee or by any two of their number; and they shall have power, when so convened, the misconduct of a competitor having been reported to them by a member of the committee or an umpire, to disqualify the offender, and, further, to order him off the ground, should his misconduct appear to them to justify such action; but before such action shall be taken, an opportunity of offering an explanation shall be afforded to the competitor whose misconduct has been reported to them. When the whole of the committee of a club or even a quorum thereof may not be available, the members of the committee that are available shall have power to act in cases left to the committee of the club.

The referee shall not bet on a match.

The referee in his discretion may at any time postpone the match on account of darkness or conditions of the ground or weather.

Foot fault judges should be most carefully chosen, and should be thoroughly conversant with the foot fault rule. They should be warned not to converse with the base linesmen.

He must be able to decide quickly and take all responsibility for his actions.

And he must know the rules.

## UMPIRE AND LINESMEN'S DIAGRAM

Competition \_\_\_\_\_

Court No. \_\_\_\_\_ Match called at \_\_\_\_\_

Umpire \_\_\_\_\_

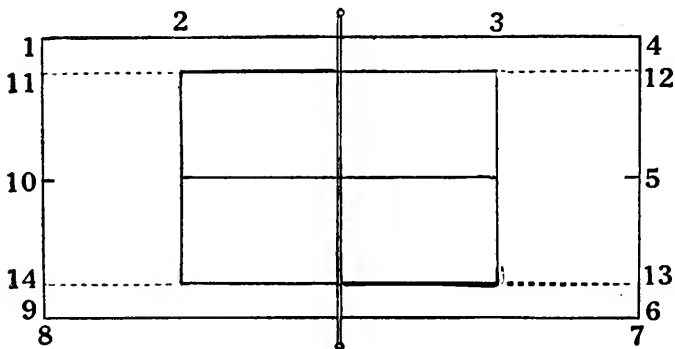

### LINESMEN, FOOT FAULT JUDGE AND NET UMPIRE

1 \_\_\_\_\_ 6 \_\_\_\_\_

2 \_\_\_\_\_ 7 \_\_\_\_\_

3 \_\_\_\_\_ 8 \_\_\_\_\_

4 \_\_\_\_\_ 9 \_\_\_\_\_

5 \_\_\_\_\_ 10 \_\_\_\_\_

Foot Fault Judge \_\_\_\_\_

Net Umpire \_\_\_\_\_

### FOR DOUBLES

11 \_\_\_\_\_ 13 \_\_\_\_\_

12 \_\_\_\_\_ 14 \_\_\_\_\_

## Umpiring and Line Umpiring

BY EDWARD C. CONLIN, CHAIRMAN NATIONAL UMPIRES' ASSOCIATION.

(Copyright, 1919, by American Sports Publishing Company.)

### DUTIES OF THE UMPIRE.

He is appointed by the referee or such other member or members of the tournament committee as may be selected for this purpose.

He may refer any point of law that he is unable to decide to the referee.

His decision on any point of law may be appealed from by the player to the referee, the latter's decision being final.

He may report the misconduct of a competitor to the referee or tournament committee.

To ascertain that the net is at the right height before the commencement of play, and to measure and adjust the net during play, if asked to do so, or if, in his opinion, its height has altered.

To call the faults (subject to Rule 10 of the Regulations for the Management of Tournaments) and lets unless he delegates such power.

To call the strokes when won, or when he is asked to call them, and to record them upon the umpire's scoring sheet.

To call the games and the sets at the end of each, or when asked to call them, and to record them on the umpire's scoring sheet.

In giving the game or set score, always call first the score of the player who is leading. For example: "The games are four to one, Mr. Murray leads, first set." "The sets are two to one, Mr. Williams leads." The set score should be announced at the end of each set, and also during the playing of a set; say, about once every four games.

To direct the competitors to change sides, in accordance with Law 24.

When appealed to during a rally, whether a doubtful ball is "in play" or not, to call "play," and at the conclusion of the rally to give his decision (subject to Rule 11 of the Regulations for the Management of Tournaments) or direct the competitors to play the stroke again.

To decide all doubtful or disputed strokes, and all points of law (subject to Rules 10 and 11 of the Regulations for the Management of Tournaments).

To be responsible for the proper conduct of the match.

In handicap matches to call the odds at the commencement of each set.

To sign the umpire's scoring sheets, and to deliver them at the conclusion of the match to such person as the committee may authorize to receive them.

Should the linesman be unable to give a decision, the umpire shall decide or shall direct the stroke to be played again.

To watch constantly for any violation of the rules and when one is committed to immediately give a decision on it. He should never wait for the players to call his attention to it and ask for a ruling. It is his duty to see that no infraction of the rules occurs and that the play is always in accordance with them.

## OFFICIALS' CARD

M \_\_\_\_\_

You have been appointed to act as  
 UMPIRE, LINESMAN, FOOT FAULT JUDGE, NET UMPIRE  
 (Cross out three)

on Court \_\_\_\_\_. Be at position marked \_\_\_\_\_  
 shown on the chart on reverse side of this card  
 on \_\_\_\_\_ 19 \_\_\_\_\_ at \_\_\_\_\_ sharp.

By accepting this card you agree  
 to be at the position designated  
 promptly at the time stated. No  
 further notification given.

FRONT OF OFFICIALS' CARD.

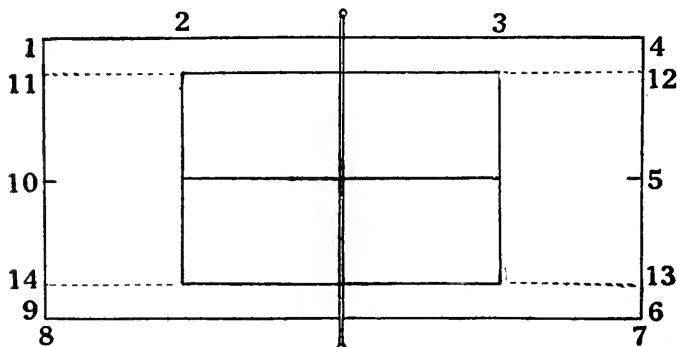

BACK OF OFFICIALS' CARD.

the decision of an umpire shall be final upon every question of fact, and no competitor may appeal from it; but if an umpire be in doubt as to a point of law, or if a competitor appeal against his decision on such a point, the umpire shall submit it to the referee, whose decision shall be final.

NOTE—A question of fact relates to events that actually happened. A question of law is the construction and application of the laws of the game to the admitted facts.

The umpire's first duty upon coming to the court is to measure the height of the net at the center and at the posts with the measuring stick, to see if it is in accordance with the rules. The net should fit flush to the net posts. He should then make sure that all his linesmen's and umpires' chairs are in position, and that his own chair is properly placed—centered to the net post, and about five feet away from it. The net also should be looked over to see that it is perfect and that there are no holes to let the ball through. Attention to all these details goes to prevent any possible delays while the match is being played, for such delays are bad for the contestants and are not enjoyed by the gallery.

Where a full corps of linesmen cannot be obtained, a very good plan to follow is to have a foot fault umpire and one man on each side of the net, on the side of the court that is opposite the umpire's chair. With this arrangement and good men, no match will suffer so far as decisions go.

The seat of the umpire's chair is about six feet from the ground, with a shelf about two feet from the ground placed inside the four supports of the chair. This shelf is used by the players as a place for extra rackets or anything else that they may want, such as rosin, extra shoelaces, sawdust (to dry their racket hands), adhesive tape, whatever they may want to drink, lemons served to cleanse their mouths, and plenty of towels. An extra supply of balls should be kept there. Under the chair and on the ground there should be two buckets of ice water for the players to bathe their faces and heads if it is necessary.

Seventeen chairs for doubles, thirteen for singles—a folding wooden chair is the best—are placed in their proper stations, care being given to see that they are a sufficient distance from the lines to be well out of the players' way. One of these chairs is for the net umpire, two are for the foot fault judges, and the remainder for the linesmen, of whom there are ten for a singles match and thirteen for doubles. Another chair is placed alongside of the umpire's stand, to be occupied by an assistant scorer, who acts as a checker should the umpire become confused in his scoring.

Near the court, in a position of advantage, is placed still another chair for the referee of the tournament, so that he may see the play and be immediately available in case the players should appeal to him from the umpire's decision, should he be called upon for any of the decisions that the rules make it his duty to give. All these chairs should be painted a dark green and numbered. It is most important for the proper conduct of a match that, with the exception of the players, the ball boys and the officials named above, no other person should be permitted inside the enclosure. This is strictly enforced.

An umpire and linesmen's card is handed to each official as he is selected; upon this card is a diagram of the court, upon which is designated the exact

position he is to fill, the competitors, number of the court and the time he is to be at his station.

While the players are warming up, the umpire should give one last look around to see that all his linesmen and umpires are at their stations and that everything else is in readiness. Then he should climb into his chair. After giving the players a reasonable length of time to warm up, he should ask them if they are ready. Upon receiving an affirmative reply, he should call:

"Linesmen ready? Players ready?"

If they are, then follows the call, "Play!"—and the match is on.

Just before the player first serving gets into position, the umpire should announce:

"Mr. So-and-So serving."

Each player, as he serves for the first time, should be similarly announced.

The umpire always should remember that he is a sort of connecting link between the match and the gallery.

He should announce his decisions and the score promptly and decisively and in a good loud voice, so that all can hear.

He should be careful not to speak while the gallery is applauding, but should wait until the applause is finished.

He should also—this is an especially important point—be most careful not to call the score while a player is serving, or while the ball is in play.

The umpire should instantly repeat the decision of the linesmen and of the fault umpire. This is by far the best method to follow, as it is next to impossible to obtain a full corps of officials, all of whom will announce their decisions loudly enough for everyone to hear.

The umpire should always keep tally on a score card. It is dangerous to try to keep it in your head. Cards for this purpose can be had for a very small amount of money. There are so many methods of keeping score that most interesting article could be written on this subject. For the present it is enough to suggest that you should adopt whatever method you find most suitable to your use.

Where the galleries are large, it is a good plan to instruct each linesman as he calls "out" or "fault," to signify his decision with a motion of his arm. Frequently the applause is so great that the linesman's voice cannot be heard by the umpire.

Where the player obstructs the linesman's view of the ball or line, the latter should immediately call, "Cannot see it"; the umpire then makes the decision or orders the point played over again as the laws specify.

Good ball boys are a great help to an umpire and a joy to the players. They can be made proficient only by careful training under a competent instructor.

At a match, the umpire must watch the court and see that it is kept clear of balls. Whenever he sees a ball that has been overlooked by a boy, he should quickly call attention to it. The ball boy must never go on a court while the ball is in play.

It is the duty of the umpire to note the time that the players leave the court for their "rest period." He should go off the court with them, and keep the posted as to how much of their seven minutes has elapsed. He must see that they are back on the court within the seven minutes allowed by the rules.

A player can be defaulted for not being back on the court within the seven minutes allowed.

In a match where there is just an umpire and no other officials, it should be arranged with the players that should they obstruct the umpire's view of the ball he shall say, "Call it," and the ball shall be played on their decision.

Once a decision is made on a stroke, the point should not be played over unless the rules so provide. This must be lived up to.

Umpires should be called by the umpire, who is in the best position to make these decisions.

An umpire can make only three calls: "Out," "Let" or, when directly appealed to, "Play."

He must keep his eye on the ball all the time it is in play. "Eyes on the ball, and nowhere else," should be his slogan.

No omission on the part of the umpire of any of the duties that the Laws of Lawn Tennis and the Regulations for the Management of Tournaments designate to him shall of itself invalidate any stroke, game or match.

He shall not bet on a match to which he is assigned.

One of the most important qualifications of umpires and linesmen is a good loud voice and a willingness to use it. *Do not be afraid to speak up.*

Under no circumstances can a player over-rule the decision of a linesman.

No self-respecting umpire or linesman will submit to having his decisions over-ruled when he is convinced that he is right.

Do not be thin-skinned. Make your decision as you see the ball played, and then stick to it. Never change your decision.

It is your job to "call them; don't explain them."

He must read, study and know the rules.

## DUTIES OF THE LINESMAN.

He is appointed by the referee or such other member or members of the tournament committee as may be selected for that purpose.

He shall call faults and decide strokes relating to the line or lines to which he is assigned and to said line or lines only, and such decision shall be final.

He must keep his eye on the ball all the time it is in play. "Eyes on the ball, and nowhere else," should be his slogan.

If he is asked by the umpire whether a ball is good, his answer must be prompt and decisive.

He should sit quietly at his station, and remain as motionless as possible, as any movement annoys the players.

One of the greatest benefits to players, umpires and spectators is for linesmen to give their decisions in a voice that all can hear.

The linesman has only one decision to make, and that is either "out" or "in." He can hardly make his announcement too loud.

He must never call "Good" unless asked for a decision by the player or umpire.

Where the galleries are large, it is a good plan for the linesman to signify his decision of "Out" with a motion of his arm made in the direction that the ball strikes out of court. Frequently the applause is so great that the linesman's voice cannot be heard by the umpire.

Do not talk to a spectator; talking may distract your attention from the match and cause you to make a bad decision by losing sight of the ball.

A linesman must not under any circumstances leave his station without the permission of the umpire and until another linesman has been put in his place.

The linesman on the center service line should be the judge as to whether the server stands within the boundary of the proper service court at that boundary, and the linesman for the side lines is the judge at that point.

Where the player obstructs the linesman's view of the ball or line, the latter should immediately call, "Cannot see it"; the umpire then makes the decision or orders the point played over again as the laws specify.

Under no circumstances can a player over-rule the decision of a linesman.

He shall not bet on a match to which he is assigned.

Know these duties and then "keep your eye on the ball."

He must read, study and know the rules.

### DUTIES OF THE NET UMPIRE.

The only duty of the net umpire is to call balls that go through the net.

### DUTIES OF THE FOOT FAULT JUDGE.

He must be thoroughly conversant with the foot fault rule.

He must not converse with the base linesmen.

He must make his decision in a voice that all can hear.

In the early days of a tournament, when on account of the number of matches it is next to impossible to have a full corps of foot fault judges, it is a wise plan to have four or five good men roaming around the courts, to watch the players and call foot faults where necessary.

Foot fault judges should remember that a foot fault only can be called where they are positive that the rule has been broken. The player must receive the benefit of any doubt.

---

Should any point arise upon which you find it difficult to give a decision on which you are in doubt as to the proper ruling immediately write, giving full details, to the Chairman of the National Umpires' Association, care of U.S.N.L.T.A., 20 Broad Street, New York City, and full instructions and explanation will be sent you. Suggestions are wanted and will be appreciated.



## Lawn Tennis Etiquette

By EDWARD C. CONLIN, CHAIRMAN NATIONAL UMPIRES' ASSOCIATION.

(Copyright, 1919, by American Sports Publishing Company.)

The most notable asset of lawn tennis is the high standard of sportsmanship developed by its players and followers through so many years that it has become *the* tradition of the game. This tradition is in your keeping, for the sport's reputation is made—or marred—by everyone playing it. Therefore you should cherish this tradition above all else, as a legacy from past generations to be handed down unimpaired to those who follow you.

With this in mind you can realize the significance of the statement that tennis is a *sportsman's* game—played for the sake of the sport. So you should acquire the “sporting” habit of mind. Know the rules, and observe them in every particular. Always give your opponent the benefit of the doubt and, at the same time, play hard, play fair, and play to win! Thus you will help to maintain the traditional place of honor for tennis in the realm of sport and will be of the greatest assistance to those who are giving their best effort to increase the prestige and popularity of the game.

Always look neat and clean on the court. Wear the clothes of a gentleman and have them clean, particularly so in a match. Every champion of the game has lived up to this, and it will not hurt your game to do so.

“Stalling” is not a nice word—keep it out of the game. You, the player, can do it; for the umpire to do so is a most difficult task. The player knows he is “stalling” before his opponent or the umpire does; it is up to you to be a sportsman, game and true.

### BEFORE THE TOURNAMENT.

Help in every way possible to make the work of the committee easier, for theirs is a hard job, at the best.

Send your entry to the person mentioned in the notice as the proper recipient. Do not give it to someone else who is apt to forget about it.

Enter only those events you expect to play in.

If you want to play in the doubles, secure a partner before you send in your entry. Do not trust to pick one up when you reach the grounds.

Put your address and telephone numbers and that of your doubles partner, also the name of the club that you belong to, on your entry.

Send your entry fee in with your entry. Do not make the committee member ask you for it. Pay for all the events you expect to play in.

### AT THE TOURNAMENT.

Bear in mind that the tournament comes before your individual preference.

Be at the courts promptly at the time the tournament notice states that play will start.

Report to the man in charge of the scoreboard just as soon as you reach the grounds, and when you do, tell him your name and your partner's, if you are playing in doubles.

Do not ask the committee every few minutes if your opponent has arrived.

Do not ask the referee to excuse you for a day, for by so doing you are apt to tie up a whole bracket. It gives him no pleasure to default you.

Do not tell the committee how to run the tournament—just play in it, that's your job.

The committee works for the good of all—they have no grudge against you.

When you go out to play a match, try to take everything with you that you think you will need. It is better for yourself, your opponent and the match.

Accept and play on the umpire's or linesmen's decision whether it is for or against you, for bad calls in a match will even up, and you must respect the official's decision or ask to have him replaced.

Be back on your court promptly after the seven minutes' rest. Do not make your opponent wait for you—play fairly to the rule on this point.

Thank the umpire when your match is finished. It is a courtesy that is appreciated by the official.

Read and know the rules, then play right up to the letter of them.

### IN GENERAL.

"Thank you" is an appeal, not an acknowledgment. Comply by returning the stray ball quickly and good-naturedly.

When returning the balls between strokes to the server, look first to see where he is standing, and return the ball as near to that part of the court as possible. Roll them along the ground and under the net if you can.

If you touch the net while the ball is in play or commit any other infraction of the rules that loses the point for you, instantly announce the fact of your doing so.

Do not leave it to your opponent to keep the point or game score. It is your job as much as his, and it makes the game run smoother and faster.

Do not call a ball that you have hit "in" or "out." That is for your opponent to do.

Do not serve until your opponent seems to be ready; a glance at him will tell whether he is or not. It is not fair to hurry your service.

When a service is a fault, let it go by you and do not hit it, as it is very apt to annoy the server as he is delivering the second ball.

Your opponent will call the balls on his side of the court, no matter what you think. Play on his call; the breaks will even up during a match. There are very few players who will knowingly call them wrong.

*Read, study and know the rules.* \_\_\_\_\_

### ETIQUETTE FOR THE GALLERY

When you are a spectator at a tennis match, you are one of the "gallery" which has assembled to see good tennis played. There are well defined (although unwritten) laws of conduct for the gallery, which are as binding upon them as the laws of tennis are upon the players and officials. Only by your co-operation in observing these unwritten laws can the perfect playing conditions be secured which make for the successful conduct of a tournament and your enjoyment of the matches you witness.

A tennis ball in play moves very fast, and other moving objects in his range of vision distract a player by making it hard for him to follow the ball's line of flight. Therefore, the ladies particularly, should be careful to keep parasols and fans in the background.

A gallery goes to a match to see good tennis played.

The committee strives to make the gallery comfortable and give to the contestants playing conditions as perfect as possible.

The committee's task of satisfying the players and pleasing the gallery is a hard one at best, and any co-operation that both can accord should be freely given. It is with this in mind that the following suggestions are made:

A moving background is the most disturbing condition that a player can experience; it makes perfect play of the ball next to impossible. For this reason you should not move about when opposite the end of a court, except when it is absolutely necessary to do so.

If you are in a stand that faces more than one court, do not move from one match to the other while the play is on; it is fatal to good play. If you want to watch the other match, wait until a set is finished before moving.

Do not applaud or give vocal expression of your feelings while a rally is on, but wait until the point has been played out and then applaud all you want to.

Do not applaud errors; by that is meant that your approval should be given to good strokes only. Do not applaud a shot that goes out of court or into the net, even if it gives a point to the player you want to win.

Do not coach the players. Never call "Good," "Out," "Let it go," "Hit it," etc., because thereby you are influencing a player's judgment, which is a factor in the outcome of the match. Furthermore, coaching interferes with the fair playing of a match and may become extremely disconcerting by causing doubt as to whether some particular call came from a spectator or was an official's decision.

Never talk to an umpire, linesman or player while a match is in progress.

If you do not agree with the decisions as they are given, withhold your disapproval; remember that the linesmen and umpires are in a better position to judge the play than you are and that the committee has selected the most competent men available for these duties.

Do not throw a stray ball into the court while play is on; wait until a stroke is finished and then roll it in.

Refrain from talking loudly while a match is on, as a player hears you and frequently takes it as a call from a linesman and does not play a good ball.

Under no circumstances walk or stand so near a court that you obstruct a contestant; this is inexcusable.

Do not walk or stand on the playing surface of a court before or after a match, as the heels of your shoes make holes in the surface that cause the ball to take bad bounds when a match is played.

Just before a match, do not try to renew an old acquaintanceship or express your wishes for victory to a player. Leave him alone; he has enough on his mind at that time. See him after the match; he has more time then and you will find him more cordial.

If you have to bring a dog with you, see that he watches the match from the side lines. All players are fond of dogs—after the match.

Know your neighbors at a tennis match before you criticize a player—friends and relatives frequently attend.

The request, "Please do not smoke," is made by the committee in their endeavor to get you to help them obey the laws of the *Fire Department* that generally apply to stands built of wood.

Bear in mind that tennis is an amateur sport, played for its own sake and not for profit. Most tournaments are run at a loss. Neither the players nor officials receive a cent for their services. The matches give pleasure to the spectators and players and your attitude toward these contests should always be governed by this consideration.

Read and know the rules; it will add to your enjoyment of the matches.

And last, do what you can to help the committee, for they are working for your pleasure.

## Regulations for the Management of Tournaments

1. At Tournaments held by clubs belonging to the United States National Lawn Tennis Association or by clubs belonging to Associations which belong to the National Association or by Associations belonging to said National Association, the Laws of Lawn Tennis as adopted for the time being by said National Association and the Regulations hereinafter contained shall be observed.

2. The Officers of the Club holding the Tournament shall have full power over all details concerning said Tournament, but shall be entitled to delegate their power to a Committee. In case no special Committee shall be appointed by the Officers of the Club holding the Tournament, the powers and functions hereinafter delegated to the Committee shall be vested in and performed by the Officers of said Club.

3. A circular shall be issued by the Committee specifying the conditions of the competition, and including names of Tournament Committee and of the Referee.

4. No cheques, orders for money or cash payments in any form shall be given as prizes, and the amount actually paid for each prize shall in no case be below the advertised value of the same, if included in circular. If any challenge cup is offered it shall be deeded to the National Lawn Tennis Association. The winner of a Challenge Cup shall be entitled to the possession of the cup until one month previous to the next competition for the cup, possession being conditional on the giving of a bond by the winner satisfactory to the Club. Should the Club give possession without such bond, it shall be liable to the National Association for the value of the cup.

5. The Committee shall elect a Referee, with power to appoint a substitute to be approved by them. The Referee or his duly appointed substitute must be present at all times when play is in progress.

6. The Referee or such other member or members of the Committee as may be selected for the purpose, shall have power to appoint Umpires and Linesmen, to assign courts and to start matches, and the Referee shall decide any point of law which an Umpire may profess himself unable to decide, or which may be referred to him on appeal from the decision of an Umpire, and such decision shall be final.

7. The Referee shall, during the Tournament, be ex-officio a member of the Committee.

8. The Committee shall help to keep order on the ground, and shall consult and decide upon any question arising out of the competition, if summoned for that purpose by the Referee or by any two of their number; and they shall have power, when so convened, the misconduct of a competitor having been reported to them by a member of the Committee or an Umpire, to disqualify the offender, and further to order him off the ground, should his misconduct appear to them to justify such action, but before such action shall be taken, an opportunity of offering an explanation shall be afforded to the competitor whose misconduct has been reported to them. When the whole of the Committee of a Club or even a quorum thereof may not be available, the members of the Committee that are available shall have power to act in cases left to the Committee of the Club.

9. It is the duty of an Umpire—

(a) To ascertain that the net is at the right height before the commencement of play, and to measure and adjust the net during play, if asked to do so, or if, in his opinion, its height has altered.

(b) To call the faults (subject to Regulation 10) and lets unless he delegates such power.

(c) To call the strokes when won, or when he is asked to call them, and to record them upon the Umpire's scoring sheet. (See example at bottom of following page.)

(d) To call the games and the sets at the end of each, or when asked to call them, and to record them on the Umpire's scoring sheet.

**NOTE**—At the end of each game the games should be called with the name of the player who is in advance, thus: "2 games to 1, B wins" or, "B leads." If the games are level the score should be called thus, "three games all," or as the case may be. At the end of each set the sets should be called in like manner.

(e) To direct the Competitors to change sides, in accordance with Law 24.

(f) When appealed to during a rally, whether a doubtful ball is "in play" or not, to call "play," and at the conclusion of the rally to give his decision (subject to Regulation 11) or direct the competitors to play the stroke again.

(g) To decide all doubtful or disputed strokes, and all points of law (subject to Regulations 10 and 11), and to be responsible for the proper conduct of the match.

(h) In handicap matches to call the odds at the commencement of each set.

(i) To sign the Umpire's scoring sheets, and to deliver them at the conclusion of the match to such person as the Committee may authorize to receive them.

Provided, that no omission of any of the foregoing duties on the part of an Umpire shall of itself invalidate any stroke, game or match.

10. It is the duty of the Linesman to call faults and to decide strokes relating to the line or lines to which he is assigned and to said line or lines only, and such decision shall be final. Should the Linesman be unable to give a decision, the Umpire shall decide or shall direct the stroke to be played again.

11. The decision of an Umpire shall be final upon every question of fact, and no competitor may appeal from it; but if an Umpire be in doubt as to a point of law, or if a competitor appeal against his decision on such a point, the Umpire shall submit it to the Referee whose decision shall be final.

**NOTE**—A question of fact relates to events that actually happened. A question of law is the construction and application of the laws of the game to the admitted facts.

#### Example:

The strokes are scored by means of pencil marks in the spaces beneath the word "STROKES," thus:

| Game. | Initials of Players. | STROKES. |   |   |   |   |   |   |   |  |  | Game won by |  |
|-------|----------------------|----------|---|---|---|---|---|---|---|--|--|-------------|--|
| 1     | A. B.                | 1        | 1 | 1 | 1 |   |   |   |   |  |  |             |  |
|       | C. D.                |          |   | 1 | 1 |   |   |   |   |  |  |             |  |
| 2     | C. D.                |          | 1 | 1 | 1 | 1 | 1 | 1 | 1 |  |  |             |  |
|       | A. B.                | 1        | 1 | 1 | 1 | 1 | 1 |   |   |  |  |             |  |

The Scoring Sheet shows that in the first game the score ran, and would have been called, thus: "15—love, 30—love, 20—15, 40—15, 40—30, game (A.B.)" In the second game: "Love—15, 15 all, 15—30, 30 all, 40—30, deuce, advantage (C.D.), deuce, advantage (A.B.), deuce, advantage (C.D.), game (C.D.)."

The score of the Server should be called first.

12. The Referee shall not bet on a match nor shall an Umpire or Linesman on the match to which he is assigned. An infraction of this rule shall be followed by the immediate removal of the offending Referee, Umpire or Linesman on the complaint of any competitor.

13. No competitor may transfer his entry to another player.

14. Competitors shall have a right, by themselves or their deputies, to be present at the draw.

15. The draw shall be conducted in the following manner: Each competitor's name shall be written on a separate card or paper, and these shall be placed in a bowl or hat, drawn out one by one at random, and copied on a list in the order in which they have been drawn.

Infraction of this rule renders a Club or other organization liable to loss of its tournament for the following year; except that in invitation tournaments, and competitions between nations, states, cities, clubs and similar bodies where the competition is really between such bodies and not between the players as individuals, players may be placed in such manner as agreed upon by the management of the competition, and except that in Intercollegiate and Interscholastic matches the draw shall be arranged to prevent members of the same college or school from meeting each other in the first and second rounds, the draw in other ways being arranged absolutely by chance.

16. When the number of competitors is 4, 8, 16, 32, 64 or any higher power of 2, they shall meet in pairs, in accordance with the system shown by the diagram at top of following page.

In scoring handicap matches, the odds received should be marked by crosses on the right of the first perpendicular thick line before the commencement of each game, thus:

| Game. | Initials of Players. | STROKES. |   |  |  |  |  |  |  |  |  | Game won by |  |
|-------|----------------------|----------|---|--|--|--|--|--|--|--|--|-------------|--|
| 1     | A. B.                | +        |   |  |  |  |  |  |  |  |  |             |  |
|       | C. D.                |          |   |  |  |  |  |  |  |  |  |             |  |
| 2     | C. D.                |          |   |  |  |  |  |  |  |  |  |             |  |
|       | A. B.                | +        | + |  |  |  |  |  |  |  |  |             |  |
| 3     | A. B.                | +        |   |  |  |  |  |  |  |  |  |             |  |
|       | C. D.                |          |   |  |  |  |  |  |  |  |  |             |  |
| 4     | C. D.                |          |   |  |  |  |  |  |  |  |  |             |  |
|       | A. B.                | +        | + |  |  |  |  |  |  |  |  |             |  |
| 5     | A. B.                | +        |   |  |  |  |  |  |  |  |  |             |  |
|       | C. D.                |          |   |  |  |  |  |  |  |  |  |             |  |
| 6     | C. D.                |          |   |  |  |  |  |  |  |  |  |             |  |
|       | A. B.                | +        | + |  |  |  |  |  |  |  |  |             |  |

Here A. B. is receiving 15 and 3-sixths of 15.

1ST ROUND.

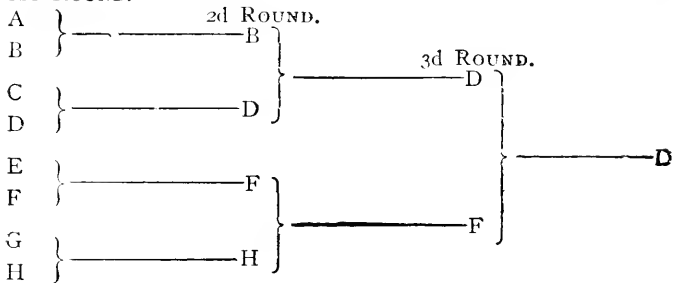

17. When the number of competitors is not a power of 2, there shall be byes in the first round. The number of byes shall be equal to the difference between the number of competitors and the next higher power of 2, and the number of pairs that shall meet in the first round

When odds are owed, they should be marked on the left of the first thick perpendicular line before the commencement of each game, thus:

| Game. | Initials of Players. | STROKES. |   |  |  |  |  | Game won by |
|-------|----------------------|----------|---|--|--|--|--|-------------|
| 1     | A. B.                | 1        | 1 |  |  |  |  |             |
|       | C. D.                |          |   |  |  |  |  |             |
| 2     | C. D.                |          |   |  |  |  |  |             |
|       | A. B.                | 1        |   |  |  |  |  |             |
| 3     | A. B.                | 1        | 1 |  |  |  |  |             |
|       | C. D.                |          |   |  |  |  |  |             |
| 4     | C. D.                |          |   |  |  |  |  |             |
|       | A. B.                | 1        |   |  |  |  |  |             |
| 5     | A. B.                | 1        |   |  |  |  |  |             |
|       | C. D.                |          |   |  |  |  |  |             |
| 6     | C. D.                |          |   |  |  |  |  |             |
|       | A. B.                | 1        |   |  |  |  |  |             |

shall be equal to the difference between the number of competitors and the next lower power of 2. The byes, if even in number, shall be divided, as the names are drawn, in equal proportions at the top and bottom of the list, above and below the pairs. If uneven in number, there shall be one more bye at the bottom than at the top. Thus—

SERIES 1—FROM 5 TO 8 COMPETITORS.

FIRST ROUND.

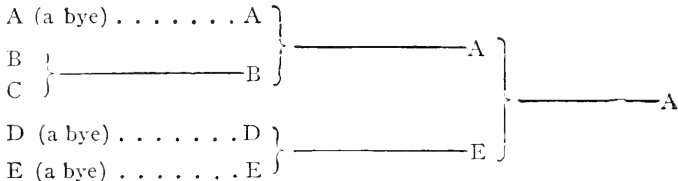

With 6, there will be one bye at the top, and 1 bye at the bottom. With 7, 1 bye at the bottom. With 8, no byes.

and should be crossed off one by one when the player owing wins a stroke, thus:

| Game. | Initials of Players. | STROKES. |   |  |  |  |  | Game won by |
|-------|----------------------|----------|---|--|--|--|--|-------------|
| 1     | A. B.                | +        | + |  |  |  |  |             |
|       | C. D.                |          |   |  |  |  |  |             |
| 2     | C. D.                |          |   |  |  |  |  |             |
|       | A. B.                |          | + |  |  |  |  |             |
| 3     | A. B.                | +        | + |  |  |  |  |             |
|       | C. D.                |          |   |  |  |  |  |             |
| 4     | C. D.                |          |   |  |  |  |  |             |
|       | A. B.                |          | + |  |  |  |  |             |
| 5     | A. B.                |          | + |  |  |  |  |             |
|       | C. D.                |          |   |  |  |  |  |             |
| 6     | C. D.                |          |   |  |  |  |  |             |
|       | A. B.                |          | + |  |  |  |  |             |

Here A. B. owes 15 and 2-sixths of 15.



## SERIES 2—FROM 9 TO 16 COMPETITORS.

With 9, 3 byes at top, and 4 at bottom.

## FIRST ROUND.

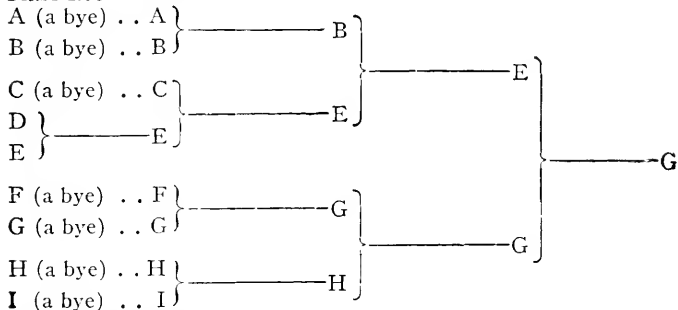

With 10, 3 byes at top, and 3 at bottom. With 11, 2 byes at top, and 3 at bottom. With 12, 2 byes at top, and 2 at bottom. With 13, 1 bye at top, and 2 at bottom. With 14, 1 bye at top, and 1 at bottom. With 15, 1 bye at bottom. With 16, no byes.

## SERIES 3—FROM 17 TO 32 COMPETITORS.

With 17, 7 byes at the top, and 8 byes at the bottom.

## 1ST ROUND. 2ND ROUND. 3RD ROUND. 4TH ROUND. 5TH ROUND.

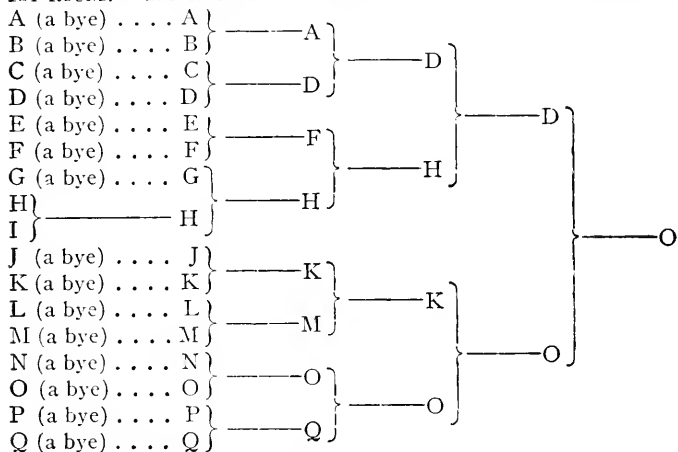

With 18, 7 byes at top, and 7 at bottom. With 19, 6 byes at top, and 7 at bottom. With 20, 6 byes at top, and 6 at bottom. With 21, 5 byes at top,

and 6 at bottom. With 22, 5 byes at top, and 5 at bottom. With 23, 4 byes at top, and 5 at bottom. With 24, 4 byes at top, and 4 at bottom. With 25, 3 byes at top, and 4 at bottom. With 26, 3 byes at top, and 3 at bottom. With 27, 2 byes at top, and 3 at bottom. With 28, 2 byes at top, and 2 at bottom. With 29, 1 bye at top, and 3 at bottom. With 30, 1 bye at top, and 1 at bottom. With 31, 1 bye at bottom. With 32, no byes.

And so on with larger numbers in the same manner.

18. If a Competitor be absent when called upon to play, or shall refuse to play, or shall have given previous notice to the Referee or to a member of the Committee that he cannot play in the next round, his adversary shall win in that round, unless said Competitor shall have been formally excused for a definite period by the Referee.

Case 1—K notifies the Committee that he is unable to be present on the day his match is scheduled. Does this constitute a valid reason for postponement or should he be defaulted?

Decision—Unless he is excused for that day by the Referee, he must be defaulted.—R. D. Wrenn.

Case 2—In a handicap tennis tournament, one round of which is to be played off each week, two opponents fail to play, through no fault of either. Should both be defaulted? Has the Committee a right to toss a coin and default the loser of the toss without the assent of the players?

Decision—When you say, "Two opponents fail to play, through no fault of their own," I do not know exactly what you mean. The usual course in any Tournament is for the Committee to state the time at which a match is to be played, and in case one of the players does not appear, it is perfectly proper for the Committee to default the absentee. If neither player is present when called upon to play, the Committee could default both players.

I should call it a very unusual and certainly not a wise proceeding for a Tournament Committee to toss a coin and default the loser of the toss without the assent of the players.

—R. D. Wrenn.

A player or doubles team cannot be compelled to play on a Sunday.

19. In handicap matches the competitors shall be handicapped by the Committee, or by a Handicapper appointed by the Committee.

20. The method of handicapping shall be by classes as follows:

GIVEN ODDS.

Class O—(Scratch).

| Class  | Receives              | Class   | Receives              |
|--------|-----------------------|---------|-----------------------|
| 1..... | 1-sixth of 15         | 10..... | 15 and 4-sixths of 15 |
| 2..... | 2-sixths of 15        | 11..... | 15 and 5-sixths of 15 |
| 3..... | 3-sixths of 15        | 12..... | 30                    |
| 4..... | 4-sixths of 15        | 13..... | 30 and 1-sixth of 15  |
| 5..... | 5-sixths of 15        | 14..... | 30 and 2-sixths of 15 |
| 6..... | 15                    | 15..... | 30 and 3-sixths of 15 |
| 7..... | 15 and 1-sixth of 15  | 16..... | 30 and 4-sixths of 15 |
| 8..... | 15 and 2-sixths of 15 | 17..... | 30 and 5-sixths of 15 |
| 9..... | 15 and 3-sixths of 15 | 18..... | 40                    |

When two players in different classes below scratch meet, the superior player shall start from scratch, and the odds received by the inferior player are as shown by the annexed table No. 1. To use the table, find in the diagonal line of figures the number representing the class of the superior player, then travel along the horizontal column until the vertical column is reached which bears at the top the num-

**HANDICAPS. TABLE No. 1. (Received Odds.)**

When two players, both in receipt of odds, meet, the player receiving the smaller odds is put back to scratch. The following table shows the point at which the other should then start. The number at the left of the horizontal columns denotes the player who goes back to scratch, those at the head of the vertical columns the player who still receives odds; and the numbers within the columns show the odds to be received by the player whose number stands at the head of the column.

|                     |                     |                     |                     |                     |                     |                     |          |          |           |           |           |           |           |           |           |           |           |
|---------------------|---------------------|---------------------|---------------------|---------------------|---------------------|---------------------|----------|----------|-----------|-----------|-----------|-----------|-----------|-----------|-----------|-----------|-----------|
| <b>1</b>            | <b>2</b>            | <b>3</b>            | <b>4</b>            | <b>5</b>            | <b>6</b>            | <b>7</b>            | <b>8</b> | <b>9</b> | <b>10</b> | <b>11</b> | <b>12</b> | <b>13</b> | <b>14</b> | <b>15</b> | <b>16</b> | <b>17</b> | <b>18</b> |
| $\frac{1}{6}$ of 15 | $\frac{2}{6}$ of 15 | $\frac{3}{6}$ of 15 | $\frac{4}{6}$ of 15 | $\frac{5}{6}$ of 15 | 15.                 | 15.1                | 15.2     | 15.3     | 15.4      | 15.5      | 30.       | 30.1      | 30.2      | 30.2      | 30.4      | 30.5      | 40.       |
| <b>1</b>            | $\frac{1}{6}$ of 15 | $\frac{2}{6}$ of 15 | $\frac{2}{6}$ of 15 | $\frac{4}{6}$ of 15 | $\frac{5}{6}$ of 15 | 15.                 | 15.1     | 15.2     | 15.3      | 15.4      | 15.5      | 30.       | 30.1      | 30.2      | 30.3      | 30.5      | 40.       |
| <b>2</b>            | $\frac{1}{6}$ of 15 | $\frac{1}{6}$ of 15 | $\frac{2}{6}$ of 15 | $\frac{3}{6}$ of 15 | $\frac{5}{6}$ of 15 | 15.                 | 15.      | 15.1     | 15.2      | 15.4      | 15.5      | 30.       | 30.1      | 30.2      | 30.3      | 30.4      | 30.5      |
|                     | $\frac{1}{6}$ of 15 | $\frac{2}{6}$ of 15 | $\frac{4}{6}$ of 15 | $\frac{5}{6}$ of 15 | $\frac{5}{6}$ of 15 | 15.                 | 15.1     | 15.1     | 15.1      | 15.3      | 15.4      | 30.       | 30.       | 30.1      | 30.2      | 30.4      | 30.5      |
|                     | <b>3</b>            | $\frac{1}{6}$ of 15 | $\frac{3}{6}$ of 15 | $\frac{4}{6}$ of 15 | $\frac{5}{6}$ of 15 | 15.                 | 15.1     | 15.2     | 15.4      | 15.5      | 30.       | 30.1      | 30.2      | 30.3      | 30.3      | 30.5      | 30.5      |
|                     | <b>4</b>            | $\frac{1}{6}$ of 15 | $\frac{2}{6}$ of 15 | $\frac{3}{6}$ of 15 | $\frac{4}{6}$ of 15 | $\frac{5}{6}$ of 15 | 15.      | 15.1     | 15.3      | 15.4      | 15.5      | 30.       | 30.1      | 30.2      | 30.2      | 30.3      | 30.5      |
|                     | <b>5</b>            | $\frac{1}{6}$ of 15 | $\frac{2}{6}$ of 15 | $\frac{3}{6}$ of 15 | $\frac{4}{6}$ of 15 | $\frac{5}{6}$ of 15 | 15.      | 15.1     | 15.3      | 15.4      | 15.5      | 30.       | 30.1      | 30.2      | 30.2      | 30.3      | 30.5      |
|                     | <b>6</b>            | $\frac{1}{6}$ of 15 | $\frac{2}{6}$ of 15 | $\frac{3}{6}$ of 15 | $\frac{4}{6}$ of 15 | $\frac{5}{6}$ of 15 | 15.      | 15.1     | 15.3      | 15.4      | 15.5      | 30.       | 30.1      | 30.2      | 30.2      | 30.3      | 30.4      |
|                     | <b>7</b>            | $\frac{1}{6}$ of 15 | $\frac{2}{6}$ of 15 | $\frac{3}{6}$ of 15 | $\frac{4}{6}$ of 15 | $\frac{5}{6}$ of 15 | 15.      | 15.1     | 15.3      | 15.4      | 15.5      | 30.       | 30.1      | 30.2      | 30.2      | 30.3      | 30.4      |
|                     | <b>8</b>            | $\frac{1}{6}$ of 15 | $\frac{2}{6}$ of 15 | $\frac{3}{6}$ of 15 | $\frac{4}{6}$ of 15 | $\frac{5}{6}$ of 15 | 15.      | 15.1     | 15.3      | 15.4      | 15.5      | 30.       | 30.1      | 30.2      | 30.2      | 30.3      | 30.4      |
|                     | <b>9</b>            | $\frac{1}{6}$ of 15 | $\frac{2}{6}$ of 15 | $\frac{3}{6}$ of 15 | $\frac{4}{6}$ of 15 | $\frac{5}{6}$ of 15 | 15.      | 15.1     | 15.3      | 15.4      | 15.5      | 30.       | 30.1      | 30.2      | 30.2      | 30.3      | 30.4      |
|                     | <b>10</b>           | $\frac{1}{6}$ of 15 | $\frac{2}{6}$ of 15 | $\frac{3}{6}$ of 15 | $\frac{4}{6}$ of 15 | $\frac{5}{6}$ of 15 | 15.      | 15.1     | 15.3      | 15.4      | 15.5      | 30.       | 30.1      | 30.2      | 30.2      | 30.3      | 30.4      |
|                     | <b>11</b>           | $\frac{1}{6}$ of 15 | $\frac{2}{6}$ of 15 | $\frac{3}{6}$ of 15 | $\frac{4}{6}$ of 15 | $\frac{5}{6}$ of 15 | 15.      | 15.1     | 15.3      | 15.4      | 15.5      | 30.       | 30.1      | 30.2      | 30.2      | 30.3      | 30.4      |
|                     | <b>12</b>           | $\frac{1}{6}$ of 15 | $\frac{2}{6}$ of 15 | $\frac{3}{6}$ of 15 | $\frac{4}{6}$ of 15 | $\frac{5}{6}$ of 15 | 15.      | 15.1     | 15.3      | 15.4      | 15.5      | 30.       | 30.1      | 30.2      | 30.2      | 30.3      | 30.4      |
|                     | <b>13</b>           | $\frac{1}{6}$ of 15 | $\frac{2}{6}$ of 15 | $\frac{3}{6}$ of 15 | $\frac{4}{6}$ of 15 | $\frac{5}{6}$ of 15 | 15.      | 15.1     | 15.3      | 15.4      | 15.5      | 30.       | 30.1      | 30.2      | 30.2      | 30.3      | 30.4      |
|                     | <b>14</b>           | $\frac{1}{6}$ of 15 | $\frac{2}{6}$ of 15 | $\frac{3}{6}$ of 15 | $\frac{4}{6}$ of 15 | $\frac{5}{6}$ of 15 | 15.      | 15.1     | 15.3      | 15.4      | 15.5      | 30.       | 30.1      | 30.2      | 30.2      | 30.3      | 30.4      |
|                     | <b>15</b>           | $\frac{1}{6}$ of 15 | $\frac{2}{6}$ of 15 | $\frac{3}{6}$ of 15 | $\frac{4}{6}$ of 15 | $\frac{5}{6}$ of 15 | 15.      | 15.1     | 15.3      | 15.4      | 15.5      | 30.       | 30.1      | 30.2      | 30.2      | 30.3      | 30.4      |
|                     | <b>16</b>           | $\frac{1}{6}$ of 15 | $\frac{2}{6}$ of 15 | $\frac{3}{6}$ of 15 | $\frac{4}{6}$ of 15 | $\frac{5}{6}$ of 15 | 15.      | 15.1     | 15.3      | 15.4      | 15.5      | 30.       | 30.1      | 30.2      | 30.2      | 30.3      | 30.4      |
|                     | <b>17</b>           | $\frac{1}{6}$ of 15 | $\frac{2}{6}$ of 15 | $\frac{3}{6}$ of 15 | $\frac{4}{6}$ of 15 | $\frac{5}{6}$ of 15 | 15.      | 15.1     | 15.3      | 15.4      | 15.5      | 30.       | 30.1      | 30.2      | 30.2      | 30.3      | 30.4      |
|                     | <b>18</b>           | $\frac{1}{6}$ of 15 | $\frac{2}{6}$ of 15 | $\frac{3}{6}$ of 15 | $\frac{4}{6}$ of 15 | $\frac{5}{6}$ of 15 | 15.      | 15.1     | 15.3      | 15.4      | 15.5      | 30.       | 30.1      | 30.2      | 30.2      | 30.3      | 30.4      |

This table was calculated upon the following data :—  
In the case of received odds—

- The average value of 1-6 is .2024
- " " " 2-6 " .3552
- " " " 3-6 " .4811
- " " " 4-6 " .6069
- " " " 5-6 " .7841

Length of a game is 4,625.0 strokes,  
15.1 means 15 and one-sixth of 15 and so on.

HANDICAPS. TABLE No. 2. (Owed Odds.)

When two players meet who are handicapped to *owe* odds, the player owing the lesser odds is placed at scratch. This Table shows the odds the other will still owe.

|                     |                     |                     |                     |                     |                     |                     |                     |                     |                     |                     |                     |                     |                     |                     |                     |                     |                     |
|---------------------|---------------------|---------------------|---------------------|---------------------|---------------------|---------------------|---------------------|---------------------|---------------------|---------------------|---------------------|---------------------|---------------------|---------------------|---------------------|---------------------|---------------------|
| 1                   | 2                   | 3                   | 4                   | 5                   | 6                   | 7                   | 8                   | 9                   | 10                  | 11                  | 12                  | 13                  | 14                  | 15                  | 16                  | 17                  | 18                  |
| $\frac{1}{6}$ of 15 | $\frac{2}{6}$ of 15 | $\frac{3}{6}$ of 15 | $\frac{4}{6}$ of 15 | $\frac{5}{6}$ of 15 | 15.                 | 15.1                | 15.2                | 15.3                | 15.4                | 15.5                | 30.                 | 30.1                | 30.2                | 30.3                | 30.4                | 30.5                | 40.                 |
| 1                   | $\frac{1}{6}$ of 15 | $\frac{3}{6}$ of 15 | $\frac{3}{6}$ of 15 | $\frac{3}{6}$ of 15 | $\frac{5}{6}$ of 15 | 15.                 | 15.1                | 15.1                | 15.2                | 15.3                | 15.4                | 30.                 | 30.1                | 30.2                | 30.3                | 30.4                |                     |
|                     | 2                   | $\frac{1}{6}$ of 15 | $\frac{2}{6}$ of 15 | $\frac{3}{6}$ of 15 | $\frac{3}{6}$ of 15 | $\frac{5}{6}$ of 15 | 15.                 | 15.                 | 15.1                | 15.2                | 15.3                | 15.4                | 15.5                | 30.                 | 30.                 | 30.1                | 30.2                |
|                     |                     | 3                   | $\frac{1}{6}$ of 15 | $\frac{1}{6}$ of 15 | $\frac{4}{6}$ of 15 | $\frac{4}{6}$ of 15 | $\frac{5}{6}$ of 15 | 15.                 | 15.                 | 15.1                | 15.2                | 15.3                | 15.4                | 15.5                | 30.                 | 30.                 | 30.1                |
|                     |                     |                     | 4                   | $\frac{1}{6}$ of 15 | $\frac{2}{6}$ of 15 | $\frac{3}{6}$ of 15 | $\frac{4}{6}$ of 15 | $\frac{5}{6}$ of 15 | 15.                 | 15.                 | 15.1                | 15.2                | 15.3                | 15.4                | 15.5                | 30.                 | 30.1                |
|                     |                     |                     |                     | 5                   | $\frac{1}{6}$ of 15 | $\frac{2}{6}$ of 15 | $\frac{3}{6}$ of 15 | $\frac{4}{6}$ of 15 | $\frac{5}{6}$ of 15 | 15.                 | 15.                 | 15.1                | 15.2                | 15.3                | 15.4                | 15.5                | 30.                 |
|                     |                     |                     |                     |                     | 6                   | $\frac{1}{6}$ of 15 | $\frac{2}{6}$ of 15 | $\frac{3}{6}$ of 15 | $\frac{4}{6}$ of 15 | $\frac{5}{6}$ of 15 | 15.                 | 15.1                | 15.2                | 15.3                | 15.4                | 15.5                | 30.                 |
|                     |                     |                     |                     |                     |                     | 7                   | $\frac{1}{6}$ of 15 | $\frac{2}{6}$ of 15 | $\frac{3}{6}$ of 15 | $\frac{4}{6}$ of 15 | $\frac{5}{6}$ of 15 | 15.                 | 15.1                | 15.2                | 15.3                | 15.4                | 15.5                |
|                     |                     |                     |                     |                     |                     |                     | 8                   | 0                   | $\frac{1}{6}$ of 15 | $\frac{2}{6}$ of 15 | $\frac{3}{6}$ of 15 | $\frac{4}{6}$ of 15 | $\frac{5}{6}$ of 15 | 15.                 | 15.1                | 15.2                | 15.3                |
|                     |                     |                     |                     |                     |                     |                     |                     | 9                   | 0                   | $\frac{1}{6}$ of 15 | $\frac{2}{6}$ of 15 | $\frac{3}{6}$ of 15 | $\frac{4}{6}$ of 15 | $\frac{5}{6}$ of 15 | 15.                 | 15.1                | 15.2                |
|                     |                     |                     |                     |                     |                     |                     |                     |                     | 10                  | $\frac{1}{6}$ of 15 | $\frac{2}{6}$ of 15 | $\frac{3}{6}$ of 15 | $\frac{4}{6}$ of 15 | $\frac{5}{6}$ of 15 | 15.                 | 15.1                | 15.2                |
|                     |                     |                     |                     |                     |                     |                     |                     |                     |                     | 11                  | $\frac{1}{6}$ of 15 | $\frac{2}{6}$ of 15 | $\frac{3}{6}$ of 15 | $\frac{4}{6}$ of 15 | $\frac{5}{6}$ of 15 | 15.                 | 15.1                |
|                     |                     |                     |                     |                     |                     |                     |                     |                     |                     |                     | 12                  | $\frac{1}{6}$ of 15 | $\frac{2}{6}$ of 15 | $\frac{3}{6}$ of 15 | $\frac{4}{6}$ of 15 | $\frac{5}{6}$ of 15 | 15.                 |
|                     |                     |                     |                     |                     |                     |                     |                     |                     |                     |                     |                     | 13                  | $\frac{1}{6}$ of 15 | $\frac{2}{6}$ of 15 | $\frac{3}{6}$ of 15 | $\frac{4}{6}$ of 15 | $\frac{5}{6}$ of 15 |
|                     |                     |                     |                     |                     |                     |                     |                     |                     |                     |                     |                     |                     | 14                  | 0                   | $\frac{1}{6}$ of 15 | $\frac{2}{6}$ of 15 | $\frac{3}{6}$ of 15 |
|                     |                     |                     |                     |                     |                     |                     |                     |                     |                     |                     |                     |                     |                     | 15                  | 0                   | $\frac{1}{6}$ of 15 | $\frac{2}{6}$ of 15 |
|                     |                     |                     |                     |                     |                     |                     |                     |                     |                     |                     |                     |                     |                     |                     | 16                  | 0                   | $\frac{1}{6}$ of 15 |
|                     |                     |                     |                     |                     |                     |                     |                     |                     |                     |                     |                     |                     |                     |                     |                     | 17                  | $\frac{1}{6}$ of 15 |

This table has been calculated upon the following data:—

In the case of owed odds—

|                                   |
|-----------------------------------|
| The average value of 1-6 is .2158 |
| “ “ “ 2-6 “ .3929                 |
| “ “ “ 3-6 “ .5188                 |
| “ “ “ 4-6 “ .6448                 |
| “ “ “ 5-6 “ .7975                 |

Length of a game is 4.6250 strokes.

In using this table supply throughout the word “owe” before the odds specified.

ber of the class of the inferior player. The odds specified at the intersection of the two columns are the odds required.

Example.—If class 3 has to meet class 9, start from the figure 3 in the diagonal line of figures, and look horizontally until the vertical column is reached headed by the figure 9. The odds given at the point of intersection of the two columns (viz. 15 and 1-6 of 15) are the odds required.

When the difference between the best and the worst players entered is great (say more than 30), it is desirable to handicap the best players at owed odds. The players above scratch (i. e., owing odds) should be classified as follows:

| Class  | Owes                  | OWED ODDS. |                       |
|--------|-----------------------|------------|-----------------------|
|        |                       | Class      | Owes                  |
| 1..... | 1-sixth of 15         | 10.....    | 15 and 4-sixths of 15 |
| 2..... | 2-sixths of 15        | 11.....    | 15 and 5-sixths of 15 |
| 3..... | 3-sixths of 15        | 12.....    | 30                    |
| 4..... | 4-sixths of 15        | 13.....    | 30 and 1-sixth of 15  |
| 5..... | 5-sixths of 15        | 14.....    | 30 and 2-sixths of 15 |
| 6..... | 15                    | 15.....    | 30 and 3-sixths of 15 |
| 7..... | 15 and 1-sixth of 15  | 16.....    | 30 and 4-sixths of 15 |
| 8..... | 15 and 2-sixths of 15 | 17.....    | 30 and 5-sixths of 15 |
| 9..... | 15 and 3-sixths of 15 | 18.....    | 40                    |

When the two players in different classes above scratch meet, the inferior player shall start from scratch, and the odds owed by the superior player are as shown by the annexed table, No. 2.

This table is to be used in the same way as the former, the class of the superior player being looked for in the horizontal line of figures at the top, and the class of the inferior player in the diagonal line of figures.

Example.—If class 12 (owe 30) meet class 7 (owe 15 and 1-6 of 15), the former must owe the latter the odds of 4-6 of 15.

21. In Championship matches and handicaps by classes, as above, advantage sets shall be played throughout.

22. The Committee may, whether appealed to by any competitor or not, postpone the meeting or any match or part of a match if, in their opinion, the state of the weather, or of the light, or the condition of the ground, or other circumstances, render it advisable to do so. In cases of postponement, Law 25 must be strictly observed.

23. In all tournaments sanctioned by the Association the use of spikes longer than one-quarter of an inch is prohibited.

24. Every organization holding an event sanctioned by the United States National Lawn Tennis Association must furnish the Ranking Committee, within ten days after the completion of any such event, with a full and complete report of all matches played therein, together with the full name and, when possible, address of each contestant.

25. The Ranking Committee must furnish all Clubs and Associations holding any such sanctioned event with blanks for the purpose of making the returns required by Regulation 24, and immediately after the Committee shall have completed the ranking, such returns must be delivered to the Secretary of the United States National Lawn Tennis Association.

26. If any Club or Association fails to make the returns required, provided for by Regulation 24, sanction for holding by the delinquent of any tournament during the following year may be refused in the discretion of the Executive Committee.

## Odds

### *The Sixths System of Handicapping.*

**In the case of received odds:**

(a) One-sixth of fifteen is one stroke given in every six games of a set in the position shown by the annexed table.

(b) Similarly, two-sixths, three-sixths, four-sixths and five-sixths of fifteen are respectively two, three, four and five strokes given in every six games of a set in the position shown by the table.

|           | 1st<br>Game. | 2d<br>Game. | 3d<br>Game. | 4th<br>Game. | 5th<br>Game. | 6th<br>Game. |
|-----------|--------------|-------------|-------------|--------------|--------------|--------------|
| 1-6 of 15 | 0            | 15          | 0           | 0            | 0            | 0            |
| 2-6 of 15 | 0            | 15          | 0           | 15           | 0            | 0            |
| 3-6 of 15 | 0            | 15          | 0           | 15           | 0            | 15           |
| 4-6 of 15 | 0            | 15          | 0           | 15           | 15           | 15           |
| 5-6 of 15 | 0            | 15          | 15          | 15           | 15           | 15           |

**In the case of owed odds:**

(a) One-sixth of fifteen is one stroke owed in every six games of a set in the position shown by the annexed table.

(b) Similarly, two-sixths, three-sixths, four-sixths and five-sixths of fifteen are respectively two, three, four and five strokes owed in every six games of a set in the position shown by the following table:

|           | 1st<br>Game. | 2d<br>Game. | 3d<br>Game. | 4th<br>Game. | 5th<br>Game. | 6th<br>Game. |
|-----------|--------------|-------------|-------------|--------------|--------------|--------------|
| 1-6 of 15 | 15           | 0           | 0           | 0            | 0            | 0            |
| 2-6 of 15 | 15           | 0           | 15          | 0            | 0            | 0            |
| 3-6 of 15 | 15           | 0           | 15          | 0            | 15           | 0            |
| 4-6 of 15 | 15           | 0           | 15          | 0            | 15           | 15           |
| 5-6 of 15 | 15           | 0           | 15          | 15           | 15           | 15           |

## INSTRUCTIONS FOR HANDICAPPING.

## GIVEN ODDS.

One-sixth of fifteen (1-6) is one stroke given by the better to the poorer player on the second, eighth, fourteenth and every subsequent sixth game in each set.

Two-sixths of fifteen (2-6) is one stroke given on the second, fourth, eighth, tenth and corresponding games in each set.

Three-sixths of fifteen (3-6 or one-half) is one stroke given on the second, fourth, sixth and every other alternate game on each set.

Four-sixths of fifteen (4-6) is one stroke given on the second, fourth, sixth, eighth, tenth, eleventh, twelfth and corresponding games on each set.

Five-sixths of fifteen (5-6) is one stroke given on the second, third, fourth, fifth, sixth, eighth, ninth, tenth, eleventh, twelfth and corresponding games on each set.

Fifteen (15) is one stroke given on every game of each set.

Fifteen and one-sixth (15.1) is two strokes given on the same games as for one-sixth, and one stroke on each of the others.

Fifteen and two-sixths (15.2) is two strokes given on the same games as for two-sixths, and one stroke on each of the others.

Fifteen and three-sixths (15.3 or half-thirty) is two strokes given on the same games as for three-sixths, and one stroke on each of the others.

Fifteen and four-sixths (15.4) is two strokes given on the same games as for four-sixths, and one stroke on each of the others.

Fifteen and five-sixths (15.5) is two strokes on the same games as for five-sixths and one stroke on each of the others.

Thirty (30) is two strokes on each game.

Thirty and one-sixth (30.1), thirty and two-sixths (30.2), thirty and three-sixths (30.3 or half-forty), thirty and four-sixths (30.4), thirty and five-sixths (30.5) and forty (40), are three strokes and two given on the corresponding games of each set, as in the fifteen series.

## OWED ODDS.

Owed (or minus) odds can also be used in exactly the same quantities, the chief difference being that the better player is required to earn the owed strokes before he begins to score, while, in the case of given odds, the poorer player is given his handicap before play starts. These owed odds may be used either in conjunction with the given odds or separately. In order that the handicaps may occur as seldom as possible in the same games, when two players meet, one of whom owes odds and the other receives them, the games on which owed strokes are paid differ from those on which the given strokes are taken. Here is the table for owed odds:

One-sixth (1-6) is one stroke owed on the first, seventh, thirteenth and every subsequent sixth game in each set.

Two-sixths (2-6) is one stroke owed on the first, third, seventh, ninth and corresponding games in each set.

Three-sixths (3-6 or one-half) is one stroke owed on the first, third, fifth and every other alternate game in each set.

Four-sixths (4-6) is one stroke owed on the first, third, fifth, sixth and corresponding games in each set.

Five-sixths (5-6) is one stroke owed on the first, third, fourth, fifth, sixth and corresponding games in each set.

Fifteen (15) is one stroke owed on each game.

Fifteen and one-sixth (15.1), fifteen and two-sixths (15.2), fifteen and three-sixths (15.3 or half-thirty), fifteen and four-sixths (15.4), fifteen and five-sixths (15.5), thirty (30), thirty and one-sixth (30.1), thirty and two-sixths (30.2), thirty and three-sixths (30.3 or half-forty), thirty and four-sixths (30.4), thirty and five-sixths (30.5) and forty (40), correspond to the fractions of fifteen, as do the larger handicaps in the table for given odds correspond to the fractions of fifteen in that table.

The simplest method for handicappers to pursue is to sort out the entries for the event they are to handicap into classes according to

the relative skill of the players. Then select the class with the greatest number of players in it and place them on scratch, handicapping all of the other players either behind or in advance of scratch by owed or given odds, so as to make all even at the odds.

In deciding upon each player's handicap, his ability as compared with the scratch men should first be considered, and then as compared with his nearest and furthest rivals in the tables of odds. Each player might meet any of the others, and the object of handicapping is to give him an exactly even chance, no matter whom his opponent may be.

It should be remembered that it is easier to owe 15, or any fraction of it, than it is to give it, and when odds of 30 are given, the poorer player's score has already reached pretty near the end of the game, and the difference between him and the best men must be very great to give the latter an even chance, should they meet.

It is very unwise to give even the poorer players over 30.3 (half-forty), and very seldom is it safe to make the given odds run higher than 30. If the difference between the best and the poorest players is very great, place the latter as far as necessary behind scratch, but do not advance the former to more than 30, or 30.3 in the most extreme cases.

## HOW TO CONDUCT A TOURNAMENT.

A tournament committee should first of all be selected, with not less than five men, and as many as possible practical workers who have the time and inclination to closely look after the interests of the club. At its first meeting, the committee should decide upon all details of the meeting. In selecting a date, it is advisable to choose one immediately before or after some established tournament in the neighborhood, for then the entries of those who are to play in the other event can generally be secured.

Application should be made to the national governing body for official sanction for the tournament, stating dates and other particulars. If any championship events are to be on the programme, official recognition must be applied for before these titles can be of any value.

A printed circular should be issued by the tournament committee, which should state plainly—(1) the name of the club and the location of the courts; (2) the date of the meeting and the hours of play; (3) the list of events, and the championship titles (if any) to be competed for, with the prizes offered for each event; (4) the amount of the entrance fees, and place and date for closing the list of entries; (5) the name of referee, handicapper and tournament committee; and (6) the time and place of the draw.

The draw should always be made by the committee in public and due notice of the time and place be given to the competitors, so that they may be present or represented when the draw is made. The draw should always be made by the Bagnall-Wilde system. (See "Tournament Regulations.")

No money or its equivalent in any form should be offered as prizes, for this would disqualify the players from future competition as amateurs. Prizes should be silver, gold, cut glass, objects of art or other souvenirs of this kind that can be marked or engraved as trophies. It is preferable to have them marked before the tournament, although lawn tennis prizes are frequently bought with the privilege of exchange, and therefore not engraved until after the tournament.

The committee should select a referee, either from among their number or outside of it. If handicaps are to be held, the referee may also be the handicapper, or a sub-committee may be appointed for this purpose. Should the referee be also a competitor, a substitute should also be appointed to act for him while he is playing.

It is important to have enough balls, and only the best quality of tournament balls should be used for matches. It is the custom at most tournaments to allow three new balls with each match, but in playing on dirt courts, the same balls can sometimes be made to do service twice. Unless there are back-stops close behind the courts, it is also well to have some small boys handy to act as ball-boys and "shack" the balls for the players.



The lines of a tournament court should be marked out fresh every day and, if easily obliterated, also between matches on the same day. The courts should always be laid north and south so that one player will not get more than his share of the glaring sunlight in his eyes. There should never be a tree within shadow distance of a tournament court either, particularly on the south side of the court.

Facilities must be provided for the players to dress, and it is a good plan to appoint one member of the committee to attend to these accommodations, and to entertain the visiting players and see that their wants are attended to.

The draw should always be posted in a conspicuous place on the grounds, where the spectators as well as the players can inspect it. If possible a programme for each day's play should be made out in advance, and due notice of all the matches of the day be posted up by the draw each day. The courts should be numbered, and a certain court and hour set for each match. One member of the committee ought also to be assigned to getting umpires for the matches and seeing that they are properly started.

It is customary to exhibit the prizes for a tournament at the club grounds during the tournament, and it generally proves an attractive feature to have them displayed on a table on the grounds, all duly labeled so that spectators can see which events they are to be given for. A refreshment tent is also an attractive feature at a tournament and the prizes are then displayed under this tent on the same or a nearby table with the punchbowl. Lemonade, or tea, crackers, cakes and sometimes small sandwiches are generally served to the players and spectators under such refreshment tent.

---

## "DEED OF GIFT" FORM FOR CHALLENGE CUPS.

### Know All Men by These Presents:

THAT.....hereby presents to the United States National Lawn Tennis Association the cup tendered herewith, to be called and known as.....and to represent..... to be held under the auspices of the United States National Lawn Tennis Association, according to such Rules and Regulations as may be, from time to time, prescribed by said Association. The winner of the said championship shall be entitled to the possession of the cup for the period during which he holds the championship, being responsible, however, for the production of the cup at the next championship contest. This cup shall become the property of the player who shall win the said championship at.....annual championship contests.....

If for any reason no contest for said championship should be held for a period of two years, the United States National Lawn Tennis Association shall have the right to dispose of said cup as shall seem proper.

IN WITNESS WHEREOF,

(Signature).....

.....

## SIMPLE METHOD OF MAKING THE DRAW.

(From American Lawn Tennis.)

Although thousands of drawings for lawn tennis tournaments are made every year only a comparatively small number of people are familiar with the subject. The matter is really very simple, and making the draw is easy if one understands the *modus operandi*.

The draw is made according to the Bagnall-Wild system, except in round robin and team matches. This system is designed to bring the players together in a predetermined number of rounds and ultimately reduce them to one player or one team by retiring the competitors defeated in each round. The ultimate player, or pair, is, of course, the winner of the tournament. The rules of the U.S.N.L.T.A. forbid "seeding" the draw except in the case of invitation tournaments and competitions between "nations, States, cities, clubs," etc.; and provide that the names of the competitors shall be placed in a bowl or hat and drawn out at random (see Regulation 17 on page 193).

In preparing to make the draw the number of entries are counted. If the total is 2, or a power of 2—4, 8, 16, 32, 64, 128, 256 or 512—there are no byes and the names are entered on the draw sheet in the order in which they are drawn. If the total is *not* 2, or a power of 2, there are byes, and the Bagnall-Wild method of drawing is resorted to; and this means nearly always, for the entries rarely total a power of 2. This method is really very simple if it is once thoroughly understood, but if it is not the drawing is quite a complicated matter and freedom from error is not easily obtained.

If it is once clearly understood what is the goal aimed at in drawing, all difficulties are passed. That goal is to bring into the second round a number of entries that is a power of 2. Once that is fixed in the mind everything is easy. There must be 2, 4, 8, 16, 32, etc., players (or pairs) in the second round. To secure this result is the object of the Bagnall-Wild system of drawing.

Here is a simple illustration of how to draw: There are, say, 41 entries, so the next higher power of 2 is 64; subtract 41 from 64, and you have the number of byes—23. This leaves 18 players in the first round—23 (byes) being subtracted from 41, the total number of entries. With 18 players in the first round one-half, or 9, go into the second round, where we already have 23 byes; if we add this 9 to the 23 byes we have 32, which is, of course, a power of 2 and the correct number. If the total had been 31 or 33, or any other number than a power of 2, it would be apparent that there is an error

|                     |                  |
|---------------------|------------------|
| 64                  |                  |
| <u>41</u>           | = 23 byes        |
| 41                  | entries          |
| <u>23</u>           | byes             |
| 2)18                | = players in 1st |
| 9                   | round            |
| <u>23</u>           | byes             |
| 32                  | = players in 2d  |
|                     | round            |
| Showing a draw with |                  |
| 41 entries          |                  |

somewhere. Never forget that the number in the second round—byes and players who survive the first round—must be a power of 2, and that this "power" is obtained by doubling 2—as 4, 8, 16, 32, etc. Finally, byes are necessary only when the number of entries is not 2 or a power of 2. For this disposition of a difficulty that troubled lawn tennis players in the early years of the game we have to thank the ingenious Mr. Bagnall-Wild.

The rest is clear sailing. The names are written on slips of paper and drawn from a hat. The byes are drawn first, and it is not necessary to "copy the names on a list," as provided in Regulation 15, for the names can now be written on the draw card or sheet, thus saving time. The byes are written in the space left for the second round, beginning at the top. In the case we are citing, with 23 byes, 11 names are written at the top and 12 at the bottom, as stated in Regulation 17. As there are 18 players in the first round, that number of spaces are left on the draw card, in the center, after the byes have been disposed of, as shown.

The method of drawing for doubles is exactly the same. The only difference is that a pair is substituted for a single player.

## SCHEDULE FOR A ROUND ROBIN TOURNAMENT.

To ascertain the number of matches to be played in a round robin tournament, multiply the number of players or teams by one less than the total number and divide by two. Thus, if there are four players or teams,  $3 \times 4 = 12 \div 2 = 6$  matches to be played.

Another method is to take the number of players or teams and set down the figures, thus: 4, 3, 2, 1. Cross off the highest figure and add together ( $3 + 2 + 1 = 6$ ).

Where a tie or ties occur, one or more additional matches must be played, unless the tie is broken in some other way.

The schedule herewith provides an interesting doubles tournament for five players. One player sits out each time. The teams play four games each round, no matter how many they win or lose. The number of games won is placed in the open brackets and the man winning the most games at the end of the fifteen frames wins the tournament.

|    | TEAMS TO PLAY |         | Player Sitting Out | 1<br>Player's Name and No. | 2<br>Player's Name and No. | 3<br>Player's Name and No. | 4<br>Player's Name and No. | 5<br>Player's Name and No. |
|----|---------------|---------|--------------------|----------------------------|----------------------------|----------------------------|----------------------------|----------------------------|
|    |               |         |                    |                            |                            |                            |                            |                            |
| 1  | 1 and 2       | 3 and 4 | 5                  |                            |                            |                            |                            | Out                        |
| 2  | 2 and 3       | 4 and 5 | 1                  | Out                        |                            |                            |                            |                            |
| 3  | 3 and 4       | 1 and 5 | 2                  |                            | Out                        |                            |                            |                            |
| 4  | 4 and 5       | 1 and 2 | 3                  |                            |                            | Out                        |                            |                            |
| 5  | 1 and 5       | 2 and 3 | 4                  |                            |                            |                            | Out                        |                            |
| 6  | 1 and 3       | 2 and 4 | 5                  |                            |                            |                            |                            | Out                        |
| 7  | 2 and 5       | 3 and 4 | 1                  | Out                        |                            |                            |                            |                            |
| 8  | 3 and 5       | 1 and 4 | 2                  |                            | Out                        |                            |                            |                            |
| 9  | 2 and 4       | 1 and 5 | 3                  |                            |                            | Out                        |                            |                            |
| 10 | 2 and 5       | 1 and 3 | 4                  |                            |                            |                            | Out                        |                            |
| 11 | 1 and 4       | 2 and 3 | 5                  |                            |                            |                            |                            | Out                        |
| 12 | 2 and 4       | 3 and 5 | 1                  | Out                        |                            |                            |                            |                            |
| 13 | 1 and 3       | 4 and 5 | 2                  |                            | Out                        |                            |                            |                            |
| 14 | 1 and 4       | 2 and 5 | 3                  |                            |                            | Out                        |                            |                            |
| 15 | 3 and 5       | 1 and 2 | 4                  |                            |                            |                            | Out                        |                            |

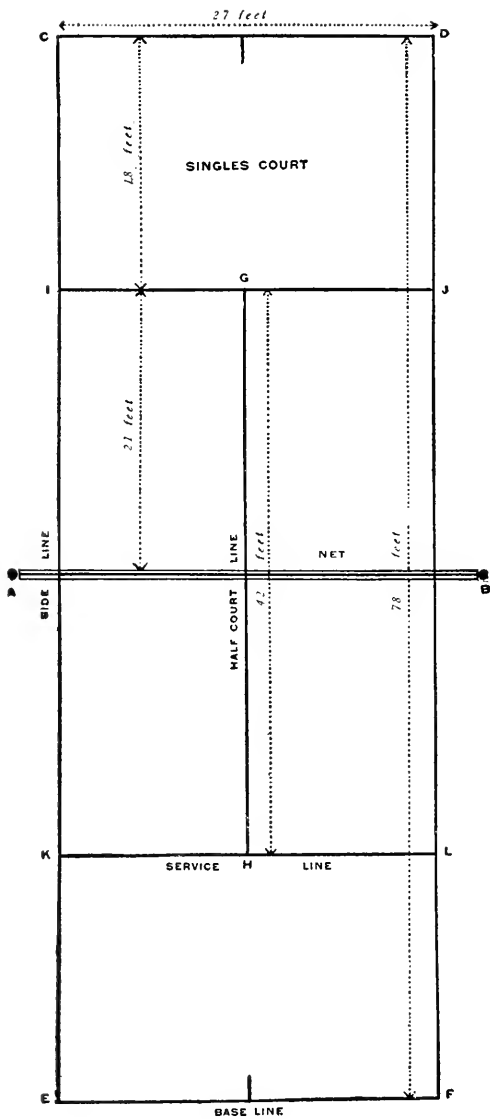

## Laws of Lawn Tennis

With \*Explanations and Comments, and Cases and Decisions assigned to the Law by which they are governed.

BY EDWARD C. CONLIN,  
Chairman of the National Umpires' Association.

During 1919 the Laws of Lawn Tennis are to be revised by the Committee on Codification of the Laws of Lawn Tennis and "Cases and Decisions," this revision to be presented to the annual meeting of the United States National Lawn Tennis Association in February, 1920, for adoption. One of the purposes of this arrangement of the Laws is to get before the players and followers of the game a reasonably complete presentment of the Laws and their application at the present time. Suggestions that will aid the Committee in this work are requested. They should be sent to the United States National Lawn Tennis Association, 20 Broad Street, New York.

### THE COURT.

**LAW** The singles court is 78 feet long and 27 feet  
**1** wide. It is divided across the middle by  
 a net, the ends of which are attached to the tops of  
 two posts, A and B, standing 3 feet outside the court  
 on each side. The height of the net is 3 feet 6 inches  
 at the posts, and 3 feet in the middle. The band at the  
 top of the net shall be not less than 2 inches nor more  
 than 2½ inches in width, and shall not have any sur-  
 plus material projecting below the sewing at the bottom  
 of said band. At each end of the court, parallel with  
 the net, and 39 feet from it, are drawn the base lines,  
 C D and E F, the ends of which are connected by the  
 side lines, C E and D F. Half-way between the side  
 lines, and parallel with them, is drawn the half-court  
 line, G H, dividing the space on each side of the net  
 into two equal parts called the right and left courts.  
 On each side of the net, at a distance of 21 feet from  
 it, and parallel with it, are drawn the service lines,  
 I J and K L.

Dimensions  
and equipment.

The marking of the half-court line between the  
 service lines and the base lines shall be omitted; but  
 the place where the half-court line would meet the  
 base lines, if it were extended, shall be indicated by

Marking.

**LAW 1.**

a mark immediately in front of the base lines. The maximum width of the half-court line shall be 2 inches.

**Measurements.**

The measurement of all lines (except the half-court line) shall be outside measurement; that is, the distance from the outside of one base line to the other shall be 78 feet; from outside of side line to side line 27 feet for the singles and 36 feet for the doubles court; from outside of service line to service line 42 feet.

**Explanation of Law 1.**

For singles court, outside measurement is 78 feet long, 27 feet wide. Service lines, 18 feet from the outside of each base line; half-court line, midway between the side lines connecting the two service lines. Immediately in front of the base lines, a mark about 4 inches long, half-way between the two side lines. Width of lines: The half-court line not over 2 inches; the other lines, usage calls for  $1\frac{1}{2}$  to 2 inches on dirt and  $1\frac{3}{4}$  inches on grass; the base line can be wider, but must be kept within the maximum length of the court—78 feet.

The doubles court is the same as the singles court except that the width is 36 feet, side lines being placed  $4\frac{1}{2}$  feet on the outside of the side lines of the singles court. Thus the side lines of the singles court become the side lines of the service courts in the doubles court and the service lines remain the same as for the singles court. The side lines of the service courts are to be marked only to the service lines and not carried beyond the service lines to the base lines. This is comparatively new, but is called for in Law 27. It is permissible, however, to extend the service side lines to the base lines, as the latter marking has to be made where a court is to be used for both singles and doubles play.

Note that all measurements are outside measurements.

The posts are 3 feet outside of the side lines in both singles and doubles.

*The Net:* Should be 33 feet wide for singles, 42 feet for doubles. Top of the band must be 3 feet 6 inches from the ground at the posts and 3 feet in the middle. The band at the top of the net is to be not less than 2 inches nor more than  $2\frac{1}{2}$  inches in depth on each side of the net. The net from top to bottom should come flush with the net posts.

Where a singles match is played on a court marked for doubles, with the net posts 3 feet outside of the side lines of the double court, a stick 3 feet 6 inches high should be placed 3 feet away from the side lines of the single court,

**LAW 1.**

to hold the net up to the proper height at the point where the net posts would be on a single court.

*Service Courts:* There are four of them, one on the right and left-hand side of the half-court line on each side of the court, the net being the dividing line. A service court consists of the space bounded by the net, the side line, the service line and the half-court line. The marks inside of and at the center of the base lines show where the half-court line would come if it extended from the service lines to the base lines, the purpose of this being to mark the point within which the server must stand.

*The Alley:* That space in the doubles court which lies between the extreme side line and the side lines of the service courts.

It is well to have a stick, similar to a piece of wooden lath, 3 feet 6 inches long, with a notch cut in at the 3 foot mark, for the purpose of measuring the height of the net at the posts and in the center. These measurements always should be made before starting to play.

**THE BALLS.**

**LAW** The balls shall measure not less than Size and  
**2**  $2 \frac{9}{16}$  inches, nor more than  $2 \frac{10}{16}$  weight  
 inches, in diameter; and shall weigh not less than 2  
 ounces nor more than  $2 \frac{1}{16}$  ounces.

**Explanation of Law 2.**

How often can the players have new balls? is a question that is frequently asked. No official ruling on this has ever been made. In big matches, new balls are always given the players at the start of a set, and it has been customary to give new balls during a set as often as a player asks for them. He usually asks his opponent if he has any objection, and it is seldom that there is objection. It would seem to me that the Umpire should decide as to the necessity of new balls and an appeal from his decision to the Referee be permitted. This, however, is my comment and not official.

Should a ball become broken through hitting, a "let" should be called.

**THE GAME.**

**LAW** The choice of sides and the right to be Choice of sides  
**3** server or striker-out in the first game shall and service.  
 be decided by toss; provided that, if the winner of  
 the toss choose the right to be server or striker-out,

**LAW 3.**

the other player shall have the choice of sides, and vice versa; or the winner of the toss may insist upon a choice by his opponent. If one player choose the court the other may elect not to serve.

**Explanation of Law 3.**

The last section of this rule should be changed to read: If one player choose the court, the other may elect to serve or not, as he wishes.

The toss is usually made by one player twirling a racket in the air, the other calling "rough" or "smooth"; which means that when the racket falls, the fine stringing (the trimming) at the head of the racket will have the rough or the smooth side up when the racket falls to the ground.

How game  
commences.

**LAW 4** The players shall stand on opposite sides of the net; the player who first delivers the ball shall be called the *Server*, and the other the *Striker-out*.

**Explanation of Law 4.**

The striker-out may stand in any part of the court that he wishes to, or in the space outside of his court, as long as he keeps on his side of the net.

**Cases and Decisions.**

*Case 1*—A player returns the ball, and, finding that he cannot stop himself before reaching the net, jumps over it. Is it a good return?

*Decision*—Law 4 requires that "the players shall stand on opposite sides of the net," and therefore the player invading his opponent's court loses the stroke.

—James Dwight.

*Case 2*—The server claims that the striker-out must stand in the court. Is this necessary?

*Decision*—No. The striker-out can stand wherever he pleases on his own side of the net.—James Dwight.

*Case 3*—A cuts the ball just over the net and it returns to A's side. B, unable to reach the ball, throws his racket and hits the ball. Both racket and ball fall over the net on A's court. A returns the ball, which goes outside of B's court. Who gets the point?

*Decision*—When B threw his racket across the net at the ball he invaded his opponent's territory and such



## LAW 4.

an invasion was in a measure responsible for A's returning the ball out of court; in other words, B would lose the point.—R. D. Wrenn.

*Case 4*—In a doubles competition the server claims the right to stand at the corner of the court as marked by the double side lines (the single court side lines not being marked). Is the foregoing correct or is it necessary that the server stand within the limits of the imaginary continuation of the half-court and the singles court side lines?

*Decision*—The server has the right to stand at the corner of the court as marked by the double side lines.

—R. D. Wrenn.

*Case 5*—In doubles, is it allowable for the partner of the server to stand in the center of the service court and thereby obstruct the view of the striker-out?

*Decision*—The partner of the server may take any position in the court that he wishes, whether it obstructs the view of the striker-out or not.

—R. D. Wrenn.

**LAW** At the end of the first game the striker-out Change of  
**5** shall become server, and the server shall service.  
 become striker-out; and so on alternately in all the subsequent games of the set and following sets.

### FOOT FAULT RULE.

**LAW** Before commencing to serve, the server How player  
**6** shall stand with both feet at rest behind shall serve.  
 (i. e., further from the net than) the base line and within the limits of the imaginary continuation of the half-court and side lines, and thereafter the server shall not run, walk, hop or jump before the service has been delivered, but the server may raise one foot from (and, if desired, replace it on) the ground, provided that both feet are kept behind the base line until the service has been delivered.

*Official interpretation of Law 6:*

**If a foot be lifted and replaced, there must be no change of position that can possibly be considered a step.**

*Definitions and further interpretations made by the Executive Committee:*

**LAW 6.**

- Definitions of proper service.
1. "The service has been delivered" at the instant of the contact of the ball and racket. (It makes no difference what the server does after the contact of the ball and racket.)
  2. It is a hop or jump if both of a player's feet are off the ground at the same time.
  3. The grounded foot may be twisted without committing a foot fault, PROVIDED that any part of it retains its contact with the ground.
  4. After standing at rest preparatory to serving, there must be no change of position that can possibly be considered a step, no matter how far back of the base line the server may take his stand. Moving one of the feet to another resting place is a step, but a step is not actually taken until the lifted foot is replaced on the ground.
  5. The server must come to a complete stop before tossing the ball in the air. Both feet must be kept behind the base line and one foot must remain on the ground until the contact of the ball and racket. The racket and any portion of the body EXCEPT THE FEET may cross the base line prior to the contact of the ball and racket.

**Explanation of Law 6.**

*It is a fault if the server touch or cross the base line before striking the ball (the racket and any part of the server's body except his feet may cross the base line before striking the ball); if he raises one foot and puts it down farther forward than it was originally; if he makes any movement that can be construed as a step or a hop, skip or jump; if both feet leave the ground before the ball is struck; or if the foot is swung forward over the base line (whether it touches the ground or not after being lifted) before the moment of impact.*

The server must stand behind the base line, within the limits of the side lines of the court in which he is playing. In singles, the server must stand between the imaginary continuation of the half-court and side service lines, but in doubles he is permitted to stand between the imaginary continuation of the half-court and the extreme outside lines.—R. D. Wrenn.

*Decision*—There is no restriction in the regulations regarding the kind of service which may be used; that is, the player may use an underhand or an overhand service at his discretion.—R. D. Wrenn.

**Cases and Decisions.**

*Case 1*—Is it a violation of the rules if the server should put his foot on the base line while serving?

*Decision*—If the server's foot touches the base line, even though it be an inch over the line, it is a fault.

—R. D. Wrenn.

## LAW 6.

*Case 2*—In serving, I understand, it is permissible to raise one foot off the ground, but would like to know whether, in bringing the foot back on the ground, it is allowable to step inside of the base line, either before or after the ball hits the ground or the net?

*Decision*—The server cannot have either foot inside of the base line until after the ball has left his racket.

—R. D. Wrenn.

At a match where there is no Foot-Fault Judge, an Umpire can call foot faults from the chair, when it is quite evident to him that they are being made. Section B of Article 9 of Regulations for the Management of Tournaments gives him this power.

**LAW 7** The service shall be delivered from the right and left courts alternately, beginning from the right in every game, even though odds be given or owed, and the ball served shall drop within the service line, half-court line and side line of the court which is diagonally opposite to that from which it was served or upon any such line.

How service is delivered.

### Explanation of Law 7.

I suggest that the following sentence be added to Law 7: The end of the game or set does not change this rotation.

It should be remembered, in handicap matches, that the server starts to serve from the right-hand court, no matter whether odds be given or owed; and that a ball striking within or on any line of the proper service court is good.

The services must always come alternately from the right and left courts; if the server delivers the ball from the wrong court, it is a fault.

A ball served with a sharp cut that bounds back over the net after having struck in the right court is a good service. The point counts in favor of the server if the striker-out fails to return it. The latter may reach over the net to return such a ball, but loses the point if he touches the net in doing so.

In the absence of a Linesman and Umpire, it is the function of the receiver to determine whether the service is good or not.

## LAW 7.

**Cases and Decisions.**

*Case 1*—A player receiving fifteen, serves from the left court. His opponent claims a fault.

*Decision*—It is a fault. The service starts from the right court under all circumstances.—James Dwight.

*Case 2*—The first ball served—a fault—strikes the back-stop and bounds back, interfering with the receiver at the time of second service. Can he claim a “let”?

*Decision*—Yes.—American Lawn Tennis.

Faults.

**LAW 8** It is a fault if the server commit any breach of Law 7, or if he does not stand as directed in Law 6, or if the ball served drop in the net (or go through it), or beyond the service line, or if it drop out of court or in the wrong court. If the server, in attempting to serve, miss the ball altogether, it does not count as a fault; but if the ball be touched, no matter how slightly, by the racket, or by the server or anything that he wears or carries, a service is thereby delivered, and the laws governing the service at once apply.

**Explanation of Law 8.**

This is very plain. It may be well to point out that if the server toss up the ball to serve and does not strike it with his racket but catches it before it touches the ground, it is a fault. This fault is frequently made and seldom called.

**Cases and Decisions.**

*Case 1*—A player serves from the wrong court; he loses the stroke, and then claims that it was a fault.

*Decision*—If the stroke was played on his first service, it is simply a fault; but if he serves twice into the wrong court, he has served two faults and lost the stroke.—James Dwight.

*Case 2*—If when the ball is served, it hits the net and goes over but not in the correct receiver's box, is it a good service or not?

*Decision*—It is a fault.—R. D. Wrenn.

*Case 3*—A serves to B; the ball hits the branch of a tree overhanging the court and drops into fair territory. Is the ball good or out?

*Decision*—The server will lose the point.

—R. D. Wrenn.

## LAW 9.

**LAW**  
**9** A fault cannot be taken.

Fault cannot  
be taken.

### Explanation of Law 9.

This means that a service that does not strike in the proper service court cannot be returned.

A fault cannot be played, and the striker-out has no option in the matter; it does not make the service good if he returns it.

### Cases and Decisions.

*Case 1*—A player serves from the wrong court; he loses the stroke, and then claims that it was a fault.

*Decision*—If the stroke was played in his first service, it is simply a fault; but if he serves twice into the wrong court, he has served two faults and lost the stroke.—James Dwight.

*Case 2*—Score, 30-15; the server served from the wrong court; no one noticed it. Just as the server was about to serve the next ball, he remarks, "I am in the wrong court and must have served last from the wrong court." All agree that he served from the wrong court. Does the point stand or does he lose the point, since he had not served the next ball?

*Decision*—The point does not stand. If he served two balls into the wrong court, he made a double fault. If he served only one ball, he still has the privilege of playing the point over, but has only one service.

—R. D. Wrenn.

**LAW**  
**10** After a fault (if it is the first fault) the server shall serve again from the same court from which he served that fault, unless it was a fault because he served from the wrong court.

How ball is  
served after  
a fault.

### Explanation of Law 10.

If the server starts to serve from the wrong court and the point is played out and the error is then discovered, it is a fault, no matter whether the server wins or loses the point. He shall then serve the second ball from the proper court. Should he serve both balls from the wrong court, it is a double fault; the server loses the point and he shall then serve from the proper court.

**LAW**  
**11** A fault cannot be claimed after the next service has been delivered.

When fault  
cannot be  
claimed.

## LAW 11.

**Explanation of Law 11.**

The preceding point is considered played out and finished when the next service is made (either the first or second ball), whether it be good or a fault, and stands as the play decided it.

**Cases and Decisions.**

*Case 1*—At fifteen-all the server by mistake serves from the left court, he wins the stroke and serves again (a fault), the mistake is then discovered. Is he entitled to the previous fault? From which court should he serve next?

*Decision*—The previous stroke stands. A fault cannot be claimed after the next service, good or not, is delivered. The next service should be from the left court, the score being 30-15, and the server has served one fault.

*Case 2*—After some preliminary, the server served from the wrong court. It was not noticed by the striker-out or the Umpire. The point was hotly contested and finally went to the server, ending the game, set and match. As the contestants were going to the clubhouse, a spectator called the attention of the Umpire to the mistake. There had, of course, been no chance for another service, which would have condoned the mistake. Must the Umpire order the game reopened, give the point to the striker-out, thus bringing the score back to deuce?

*Decision*—The point goes to the server, and the match is finished and over. The Umpire should not, under any circumstances, order the game reopened.

—R. D. Wrenn.

Ball not to  
be served till  
striker-out  
is ready.

**LAW 12** The server shall not serve till the striker-out is ready. If the latter attempt to return the service, he shall be deemed ready.

**Explanation of Law 12.**

By this rule the striker-out can refuse the service if he is not ready for it. If, however, he makes any apparent attempt to return it, he shall be deemed ready and the point scored against him.

The server must wait until the striker-out is ready for the second service as well as the first, and if the striker-out claims to be not ready and does not make any effort to return the second service, the server cannot claim the point, even though the service was good.

## Cases and Decisions.

*Case 1*—The service is delivered before the striker-out is ready. He tries to return it and fails. Is he entitled to have it played over again?

*Decision*—No; if he attempts to return the service, he is deemed ready.

*Case 2*—The striker-out calls "not ready," for a second service. The ball strikes beyond the service line, and the striker-out claims that the fact that he was not ready makes no difference, since a fault cannot be returned, and, therefore, that two faults have been served.

*Decision*—The second service goes for nothing. A player cannot call "not ready," and then have the service count, or not, as suits his interests.

*Case 3*—In receiving the service, a second ball was served to me while the first one (a "let") was still in the air, and the two came into contact. I made no attempt to accept the second service.

*Decision*—The fact that the first ball was still in the air, over the service court, was clear evidence that you were "not ready" to accept the second service. It should be called a "let" and another ball served to you.—American Lawn Tennis.

**LAW 13** A service or fault delivered when the striker-out is not ready counts for nothing. When service or fault does not count.

### Explanation of Law 13.

This is perfectly plain and needs no explanation.

**LAW 14** The service shall not be volleyed; that is, taken, before it has touched the ground. Service can not be volleyed.

### Explanation of Law 14.

This means that the service must strike in the proper service court and the ball be played from the first bound.

**LAW 15** A ball is in play on leaving the server's racket, except as provided for in Law 8, and remains in play till the stroke is decided. When ball is in play.

### Explanation of Law 15.

This is perfectly clear, except that the ball can become dead by the players being interfered with by something beyond their control.

## LAW 15.

If one partner of a doubles team strikes at a ball and does not touch it, his partner still has the right to return it. A player or different member of a team may strike at a ball as often as they please; it is still in play until hit. The ball is always in play until it has struck the ground outside of the court, or the net, or has touched the ground twice. The player loses a point if the ball touches him or his clothing while still in play, no matter whether he is standing outside of the court when the ball hits him, or not.

If in the Umpire's opinion a call by an unauthorized person actually interferes with a contestant's playing of the stroke, the point should be played over.

A ball is dead the instant it has touched the ground outside of the court, and the point must be scored at once against the other side, no matter what happens *after* the ball touches the ground.

### Cases and Decisions.

*Case 1*—A ball drops near a line, the player appeals, and the Umpire calls "play." The player misunderstands the call and lets the ball fall. He then claims to have the stroke played again.

*Decision*—The stroke stands.—James Dwight.

The English ruling on this (No. 4 of Knotty Points) is a "let" and is in accord with logic and common sense. Under our rules we have to be guided by Dr. Dwight's decision.

*Case 2*—In a doubles match, is one of the players allowed to tell his partner to let the return volley go (when it may be going out) or must he keep silent? Does the telling his partner count against his side so that the opponent's side may claim the point?

*Decision*—In a doubles match, the player can give his partner any advice he wishes and is at perfect liberty to tell his partner to let a return volley go, if, in his opinion, it is going out.—R. D. Wrenn.

*Case 3*—A ball was driven to the base line of the opponent's court. The latter was in doubt whether it was good or not and he called to the Umpire for a decision. The Umpire not being able to give an instant decision, directed the men to continue playing. They did so, and, finally, the man who asked for the decision, knocked the ball out of court. The Umpire had by that time confirmed his first impression—that the disputed ball was out—and he awarded the point to the player who had, in



the course of the rally, knocked the ball out. Was the Umpire right?

*Decision*—He was; Section F of Rule 9 of the Regulations for the Management of Tournaments covers this.—American Lawn Tennis.

**LAW 16** It is a good return even though the ball touch the net in going into the proper court; but a service, otherwise good, which touches the net shall count for nothing and shall be termed a "let." Good return.

### Explanation of Law 16.

During the service, a ball that touches the net in going into the proper court is termed a "let" and counts for nothing, another service being delivered. If the ball touches the net when going into the proper court during a rally, it is good.

A served ball is only a "let" if otherwise good, falling in the proper court; a fault cannot be a "let."

There is no limit to the number of "let" balls that may be made on the service, and the server continues serving in the same court until a good service is delivered or two faults are made.

A return made from outside of the court that passes outside of the net and posts without going over them is still good if the ball falls in the proper court.

An officially recognized decision has been rendered that makes any support of the net—the posts, the guy-ropes, or the center fork—a part of the net itself, and any ball hitting one of the supports and still striking the right court is considered a good return (except on the service). The posts are required to stand outside of the court, and yet a ball being returned at a sharp angle from outside might well be going in and still touch one of the posts.

A return that passes between the net post and the net but below the top cord of the net, is not a good return because the net should fit flush to the net posts. The purpose of the net is to serve as a barrier, from post to post, between the players.

### Cases and Decisions.

*Case 1*—A ball passes outside the post of the net and strikes in court. Is it a good return?

*Decision*—Yes.—James Dwight.

## LAW 16.

*Case 2*—A ball going out of court hits the top of the posts of the net and bounds into the opposite court.

*Decision*—It is a good return.—James Dwight.

*Case 3*—The service or the ball in play strikes a ball lying in the court. Can it be returned?

*Decision*—Yes, if it is clear to the Umpire that the right ball is returned.—James Dwight.

*Case 4*—A return strikes the cord running along the bottom of the net and bounds over. Is it a good return?

*Decision*—Yes.—James Dwight.

*Case 5*—A leaves a ball in his own court, and during the course of play B returns a ball which strikes the other ball.

*Decision*—A may still return the ball in play.

—R. D. Wrenn.

*Case 6*—The first ball served was a fault, but instead of rolling outside the lines of the court, it remains about in the center of the court on the same side of the net from which the ball had been served. The second ball was good and, after being returned four or five times, it struck the first ball, taking a bad bound, the player being unable to return it.

*Decision*—The server (i.e., the man in whose court the ball was left) would lose the point. It is his business to keep the balls out of the court, and in this case he could have stopped between his services to remove the ball in question.—R. D. Wrenn.

*Case 7*—Is it a good return if the striker-out returns a service holding the racket in both hands?

*Decision*—Yes.

When server  
wins stroke.

**LAW 17** The server wins a stroke if the striker-out volley the service, or if he fail to return the service or the ball in play; or if he return the service or the ball in play so that it drops outside of his opponent's court; or if he otherwise lose a stroke, as provided by Law 20.

### Explanation of Law 17.

The server wins the point if the striker-out hits the service before it strikes the ground or lands into the proper service court; or if, in returning a good service, he drives the ball into the net or out of the court; or if he otherwise loses a stroke as provided by Law 20.

A player does not lose a stroke for striking at a ball that ultimately falls outside his court, provided he does not touch it in doing so.

### Cases and Decisions.

*Case 14*—A player is struck by the ball served before it has touched the ground, he being outside of the service court. How does it count?

*Decision*—The player struck loses the stroke. The service is presumably good until it strikes in the wrong court. A player cannot take the decision upon himself by stopping the ball. If it is going to be a fault, he has only to get out of the way.

—James Dwight.

**LAW 18** The striker-out wins a stroke if the server serve two consecutive faults, or if he fail to return the ball in play, or if he return the ball in play so that it drops outside of his opponent's court, or if he otherwise lose a stroke as provided by Law 20.

When  
striker-out  
wins stroke.

### Explanation of Law 18.

The striker-out wins the point if the server serves a double fault, or if the server drives the ball out of the court, or if he fails to return it, or if he otherwise loses a stroke as provided by Law 20.

A player does not lose a stroke for striking at a ball that ultimately falls outside his court, provided he does not touch it in doing so.

### Cases and Decisions.

*Case 1*—A ball drops near a line, the player appeals, and the Umpire calls "play." The player misunderstands the call and lets the ball fall. He then claims to have the stroke played again.

*Decision*—The stroke stands.—James Dwight.

*Case 2*—A high line ball is struck by the man playing at the net and by the man playing back (usually the server), both players missing the ball, which drops outside the court and neither of the men calling "out" (before the first man struck at it), who wins the point?

*Decision*—The point is won by the man who struck at the ball and missed it. The fact that either of the players had tried to hit the ball has no bearing on the case. The man who played the ball out of court loses the point.—R. D. Wrenn.

**LAW 19.**

Ball falling  
on line is  
in court.

**LAW 19** A ball falling on a line is regarded as falling in the court bounded by that line.

**Explanation of Law 19.**

This is perfectly plain; a ball falling on the line is good.

When player  
loses stroke.

**LAW 20** Either player loses a stroke if the ball touch him, or anything that he wears or carries, except his racket in the act of striking; or if he touch the ball with his racket more than once; or if he, or his racket, touch the net or any of its supports, or the ground within his opponent's court, while the ball is in play; or if he volley the ball before it has passed the net.

**Explanation of Law 20.**

Should the ball touch a player while it is in play, no matter if the player is standing in or out of the court, he loses the point, and it should be remembered that a ball is good until it strikes the ground outside of the court. Should the player's racket touch the net, the posts or any part of them, or if he steps into his opponent's court, or drops his racket into his opponent's court while the ball is still in play, he loses the point. If his racket strikes the ball before it comes over the net into his court, he loses the point. He can, however, strike the ball while it is in his court and permit his racket to follow the ball across the net without losing the point.

A ball served with a sharp cut that bounds back over the net after having struck in the right court is a good service. The point counts in favor of the server if the striker-out fails to return it. The latter may reach over the net to return such a ball, but loses the point if he touches the net in doing so.

**Cases and Decisions.**

*Case 1*—A player standing outside the court volleys the ball or catches it in his hand, and claims the stroke because the ball was certainly going out of court.

*Decision*—He loses the stroke. It makes no difference where he was standing. The return is presumed good until it strikes the ground outside of the court.

—James Dwight.

*Case 2*—A ball having been played over the net bounds back into the court from which it came. The player

reaches over the net and plays it before it falls. Has he a right to do so?

*Decision*—Yes, provided he does not touch the net. He has a right to play the ball at any time from the moment it crosses the net into his court until it touches the ground a second time.—James Dwight.

**Case 3**—A ball is played into the net; the player on the other side, thinking that the ball is coming over, strikes at it and hits the net. Who loses the stroke?

*Decision*—It is simply a question of fact for the Umpire to decide. If the player touch the net while the ball was still in play, he loses the stroke.

—James Dwight.

**Case 4**—Can a player follow a ball over the net with his racket, provided that he hits the ball on his own side of the net?

*Decision*—Yes; the only restrictions are that he shall not volley the ball until it has crossed the net, and that he shall not touch the net or any of its supports.

—James Dwight.

**Case 5**—A player's racket slips out of his hand and flies into the net. Does he lose the stroke for hitting the net?

*Decision*—Yes, if the ball be still in play. It does not matter if the racket be in a player's hand or not.

—James Dwight.

**Case 6**—A player's racket leaves his hand, but meets the ball and returns it over the net. Is it a good return?

*Decision*—Yes. There is no law requiring a racket to be in a player's hand when the ball is returned. It would unquestionably be a good return if the racket were held against the ground by a player's feet, and the ball bounded back off of it.—James Dwight.

**Case 7**—A singles match is played with a doubles net and inside posts. A player touches the net beyond the inside posts and claims that he does not lose the stroke because there should be no net more than three feet outside of the court.

*Decision*—He loses the stroke. The net where he touches it is part of the supports of the net. He might, perhaps, have objected to the arrangement of the net before the match.—James Dwight.

**Case 8**—During a rally the ball strikes the net, and after it has struck the net, but before it hits the ground on

## LAW 20.

either side, the player who was about to return the ball hits the net with his racket. Who wins the point?

*Decision*—The player who hits the net with his racket loses the point on the ground that the ball is not dead until it strikes the ground or is caught fast in the lower part of the net. It is perfectly possible to conceive a case where the ball would strike several inches under the net band, but still would roll over because of a heavy top spin or because it had been played up from directly under the net.—R. D. Wrenn.

*Case 9*—A and B are playing and B returns the ball to A, who is in the back part of the court, but runs up and smashes the ball, which bounds along the ground three or four times before A runs into the net. A claims it is his point, as the ball was dead (having hit the ground three or four times) before he ran into the net. B claims it is his point, as A violated the rules by running into the net.

*Decision*—A wins this point, since he did not touch the net until after the ball was dead; that is, ceased to be in play.—R. D. Wrenn.

*Case 10*—A and B are playing C and D (doubles). D is serving. A returns the ball over C's head, but C strikes at it but does not touch the ball, but does hit the net with his racket. Then D makes a successful return of the ball. The question is, Do C and D lose the point by reason of C hitting the net while the ball is still in play?

*Decision*—C and D lose the point.—R. D. Wrenn.

A "let." **LAW 21** In case a player is obstructed by any accident not within his control, the ball shall be considered a "let." But when a permanent fixture of the court is the cause of the accident the point shall be counted. The benches and chairs placed around the court, and the umpire and linesmen, shall be considered permanent fixtures. If, however, a ball in play strike a permanent fixture of the court (other than the net or posts) before it touches the ground, the point is lost; if after it has touched the ground, the point shall be played out.

### Explanation of Law 21.

This means that if in the Umpire's judgment a player is interfered with by the gallery or someone standing near the court while he is playing, the ball is considered a "let" and does not count; but if it strikes in the right

court and on the first bound hits a backstop, bench or chair placed around the court, or an Umpire or a Linesman, these are considered permanent fixtures and the point shall be played out. If, however, a ball should strike any of these before it touches the ground, the point is lost, but it has to be played if it has touched the ground inside the proper court.

An officially recognized decision has been rendered that makes any support of the net—the posts, the guy-ropes, or the center fork—a part of the net itself, and any ball hitting one of the supports and still striking the right court is considered a good return (except on the service). The posts are required to stand outside of the court, and yet a ball being returned at a sharp angle from outside might well be going in and still touch one of the posts.

### Cases and Decisions.

*Case 1*—A bystander gets in the way of a player who fails to return the ball. May he then claim a “let”?

*Decision*—Yes, if, in the Umpire’s opinion, he was prevented by an accident beyond his control. For instance, if the ropes or the seats are allowed to be so near to the court that a player is interfered with by them, the stroke should not be played again, because the ropes and seats form part of the arrangements of the ground. If, however, a spectator passes in front of those seats, or places a chair nearer than the original line, and so interferes with a player, the stroke should be played again.—James Dwight.

*Case 2*—A player is interfered with as above, and the Umpire directs the stroke to be played again. The server had previously served a fault. He claims the right to two services.

*Decision*—The fault stands. A “let” does not annul a previous fault.—James Dwight.

*Case 3*—A return hits the Umpire, or his chair or stand, the player claims that the ball was going into court.

*Decision*—Stroke is lost.—James Dwight.

*Case 4*—A player serves. He hears the Umpire call, but cannot hear what he says. He knows that the only two things that the Umpire should call are “fault” and “let,” and that in neither case can the ball be in play. He, therefore, does not return it, only to find that the Umpire has called “play.” Has he any redress?

*Decision*—Yes. A “let” shall be called and the point played over.—James Dwight.

**LAW 21.**

*Case 5*—The Umpire calls “fault,” and then instantly changes and says “play.” The striker-out fails to return the ball, and he claims he was prevented by the Umpire, and also that the Umpire cannot change his decision.

*Decision*—The Umpire should call a “let” and the service be taken again.—James Dwight.

*Case 6*—During play a ball is thrown into court, and the ball in play strikes it or a player steps on it. May a “let” be claimed?

*Decision*—Yes.—James Dwight.

*Case 7*—A drive strikes in court and on the first bound hits the backstop. As it bounds back, and before it strikes the ground again, the player returns it into his opponent's court. Is it a good return?

*Decision*—Yes.

Scoring. **LAW** On either player winning his first stroke, **22** the score is called 15 for that player; on either player winning his second stroke, the score is called 30 for that player; on either player winning his third stroke, the score is called 40 for that player; and the fourth stroke won by either player is scored game for that player, except as follows: If both players have won three strokes, the score is called deuce; and the next stroke won by either player is scored advantage for that player. If the same player win the next stroke, he wins the game; if he lose the next stroke the score returns to deuce, and so on until one player wins the two strokes immediately following the score of deuce, when game is scored for that player.

**Explanation of Law 22.**

This is the method of scoring the points of the game and cannot be made plainer. Why the figures of 15, 30, 40, and love for nothing are used, cannot be explained; but these terms have been used as long as the game has been played and seem to be satisfactory.

How winner of set is decided. **LAW** The player who first wins six games wins **23** the set, except as follows: If both players win five games the score is called games-all; and the next game won by either player is scored advantage game for that player. If the same player win the next game, he wins the set; if he lose the next game, the



## LAW 23.

score returns to games-all; and so on, until either player wins the two games immediately following the score of games-all, when he wins the set. But the committee having charge of any tournament may in their discretion modify this rule by the omission of advantage sets.

**Explanation of Law 23.**

This is the method of scoring the games in a set and seems to meet with the full approval of everyone. The law plainly states the method.

**Cases and Decisions.**

*Case 1*—The score is five-games-all and the Umpire directs the players to play an advantage set. The advantage game has been won, when it is discovered that no advantage sets are to be played. What is to be done?

*Decision*—The set is won at the eleventh game. It is no part of the Umpire's duty to decide on the conditions of the matches.—James Dwight.

*Case 2*—A and B, who started the service, win the first five games; then C and D win the next three. A and B win the next game, which makes the score 6 to 3. Do A and B win the set at the ninth game notwithstanding C and D have not served as many times as A and B?

*Decision*—The score of 6 to 3 would end the set whether or not C and D served as many times as their opponents.—R. D. Wrenn.

**LAW 24** The players shall change sides at the end of the first, third and every subsequent alternate game of each set and at the end of each set, unless the number of games in such set be even, in which case the change is not made until the end of the first game of the next set. It shall, however, be open to the players by mutual consent and notification to the umpire before the opening of the second game of the match to change sides instead at the end of every set until the odd and concluding set, in which they shall change sides at the end of the first, third and every subsequent alternate game of such set.

When players change sides.

**Explanation of Law 24.**

The change of courts is made after every odd game of the set, not of the match. If the total number of games played in a set is even, you play the first game of the next set in

**LAW 24.**

the same court in which you finish the preceding set; then change, play two games and change again, and so on.

If the number of games in a set is odd, you change, play one and change again. Change courts after the first game of each set.

The set is considered the unit, not the match.

It can be agreed before the match starts, to change courts only at the end of a set until the odd and concluding set; in this set you change after the odd game.

It is the Umpire's duty to direct the competitors to change sides, in accordance with this law (Section E, Regulation 9, of Regulations for the Management of Tournaments).

Play to  
be continuous.

**LAW** In all contests the play shall be continuous  
\*25 from the first service till the match be concluded; provided, however, that at the end of the third set either player is entitled to a rest, which shall not exceed seven minutes; and provided, further, that in case of an unavoidable accident, not within the control of the contestants, a cessation of play which shall not exceed two minutes may be allowed; but this proviso shall be strictly construed, and the privilege never granted for the purpose of allowing a player to recover his strength or wind. The referee in his discretion may at any time postpone the match on account of darkness or condition of the ground or weather. In any case of postponement, the previous score shall hold good. *Where the play has ceased for more than an hour, the player who at the cessation thereof was in the court first chosen shall have the choice of courts on the recommencement of play.* He shall stay in the court he chooses for the remainder of the set. The last two sentences do not apply when the players change every alternate game, as provided by Law 24.

**Explanation of Law 25.**

The seven minutes' rest can be taken *only after the third set*. It cannot be taken before the third set or at any time after the fourth set has been started. It must be taken after the third set or not at all.

\*All matches in which women take part in tournaments held under the auspices of the United States National Lawn Tennis Association shall be the best two in three sets, with a rest not exceeding seven minutes after the second set.

In women's matches, *after the second set or not at all.*

There is no rest in a two-out-of-three set match.

The players must be back on the court seven minutes after play has ceased.

Should a player, on account of physical unfitness or an unavoidable accident not within his control, be unable to continue play after a period of two minutes, he must be defaulted.

The Referee or the Committee postpones the match, not the Umpire.

In case of a postponement, the match is resumed from the point, game and set score existing when the match was stopped, *unless* it is mutually agreed between the players and the Referee to play the entire match over.

If play has been suspended for more than an hour in a match where the players are *changing courts only at the end of each set*, when play is resumed the player who was in the court, when the match was stopped, that was taken by the player who had choice of courts when the match was first started, shall have the choice of courts on the recommencement of play. This does not apply where the players are changing at the end of the odd games of the match.

While there is nothing in the rules that covers it, a player should not be coached by a spectator and never by a Linesman. It is not good sportsmanship.

"Stalling" is one of the hardest things to deal with. The rules say that "the play shall be continuous." A determined Umpire can nearly always apply the remedy if he goes about it right. He must determine whether the "stalling" is deliberate and for the purpose of gaining time. If he decides that it is, he should warn the player to stop this unfair practice; if this does not end it, he should then default him.

Rule 22 of the Regulations and Management of Tournaments says: "The Committee may, whether appealed to by any competitor or not, postpone the meeting or any match or part of a match if, in their opinion, the state of the weather, or of the light, or the condition of the ground, or other circumstances, render it advisable to do so. In cases of postponement, Law 25 must be strictly observed.

### Cases and Decisions.

*Case 1*—Is there any period of rest permitted after the second set in a two-out-of-three set match except in women's events?

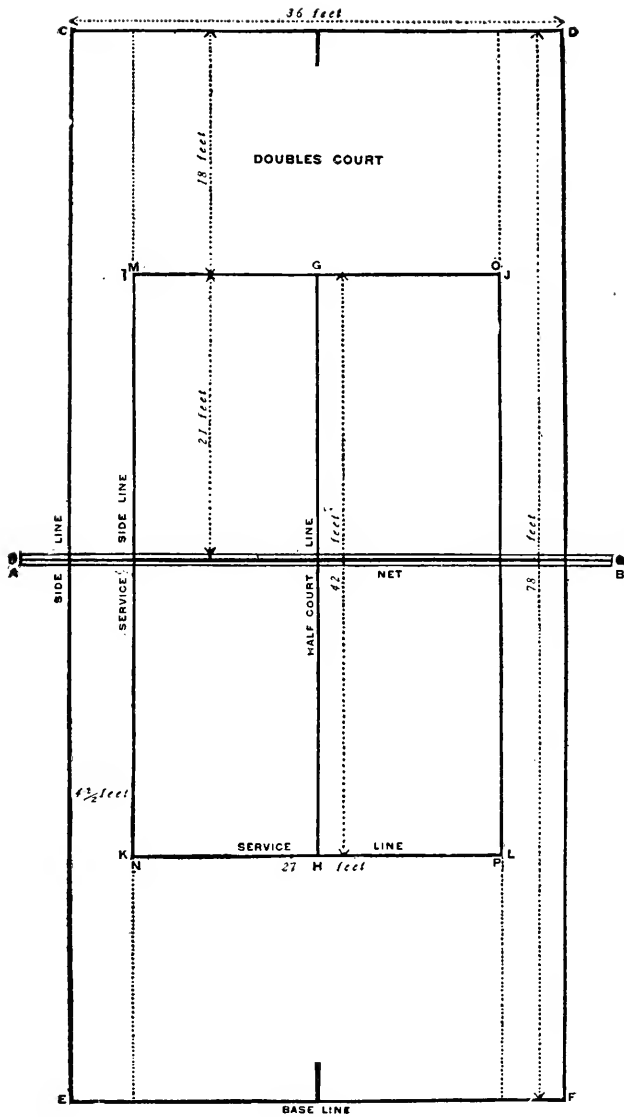

Lines M N and O P should extend only to the service lines I J and K L, but the dotted lines show that the service side lines may be extended to the base lines, as provided in the second paragraph of Law 27.

*Decision*—No; a two-out-of-three set match between men must be played without any rest whatever.

—R. D. Wrenn.

*Case 2*—Should a handicap match be replayed entirely because the two contestants made a mistake in playing best in three sets instead of best in five sets?

*Decision*—The match must be played over entirely.

—R. D. Wrenn.

When play is stopped on account of darkness or rain, a match must be resumed with the score exactly the same as where left off, unless by mutual agreement it is played all over again.—R. D. Wrenn.

**LAW 26** If a player serve out of his turn, the umpire, as soon as the mistake is discovered, shall direct the player to serve who ought to have served. But all strokes scored before such discovery shall be counted. If a game shall have been completed before such discovery, then the service in the next alternate game shall be delivered by the player who did not serve out of his turn, and so on in regular rotation.

Procedure when server plays out of turn.

### Explanation of Law 26.

A point or game that has been played out and finished stands, even though the wrong player has served. The match goes on as though no error had been committed, the player who did not serve out of turn serving next.

### Cases and Decisions.

*Case 1*—A player serves a fault and it is then discovered that it is his partner's service. Does the fault stand?

*Decision*—Yes.—James Dwight.

The foregoing laws shall apply to the three-handed and four-handed games, except as follows:

**LAW 27** For the three-handed and four-handed games the court shall be 36 feet in width;  $4\frac{1}{2}$  feet inside the side lines, and parallel with them, but extending only to the service lines, are drawn the service side lines M N and O P.

Dimensions of doubles court.

Clubs and associations holding tournaments may, however, retain the customary method of marking (i. e., by extending the service side lines to the base

**LAW 27.**

lines) if this will avoid delay in the conduct of the meeting.

**Explanation of Law 27.**

This has been covered under Law 1.

When single  
player shall  
serve.

**LAW 28** In the three-handed game, the single player shall serve in every alternate game.

**Explanation of Law 28.**

It should be agreed before the match is started whether the single player's court is to be bounded by the lines of a doubles or singles court.

Partners decide  
which one  
shall serve.

**LAW 29** In the four-handed game, the pair who have the right to serve in the first game shall decide which partner shall do so; and the opposing pair shall decide in like manner for the second game. The partner of the player who served in the first game shall serve in the third, and the partner of the player who served in the second game shall serve in the fourth, and the same order shall be maintained in all the subsequent games of the set.

**Explanation of Law 29.**

At the start of any new set a pair may change the order of service or receiving from that followed in the preceding set. This order cannot be changed during a set.

It is optional with them which shall serve first, but they must serve alternately throughout each set.

**Cases and Decisions.**

*Case 1*—In a four-handed competition, one player does not appear in time to play, and his partner claims to be allowed to play single-handed against the opposing pair. May he do so?

*Decision*—No.—James Dwight.

Server after  
set is played.

**LAW 30** At the beginning of the next set, either partner of the pair which struck out in the last game of the last set may serve; and the same privilege is given to their opponents in the second game of the new set.

**Explanation of Law 30.**

This is covered under Law 29.

**LAW 31.**

**LAW 31** The players shall take the service alternately throughout the game; a player cannot receive a service delivered to his partner; and the order of service and striking out once established shall not be altered, nor shall the striker-out change courts to receive the service, till the end of the set.

Players take service alternately.

**Explanation of Law 31.**

Both of the opponents of the servers in doubles are strikers-out alternately during a game.

The formation of a doubles team cannot be changed during a set; only at the start of a new set. The law is very plain.

In doubles, partners must receive throughout each set on the same sides of the court which they originally select when the set begins. The first server is not required to receive in the right court; he may select either side at the beginning of the set, but must hold this to the end.

**LAW 32** It is a fault if the ball served do not drop between the service line, half-court line and service side line of the court diagonally opposite to that from which it was served.

Faults.

**Explanation of Law 32.**

Should the ball when served strike a permanent fixture of the court and drop into the proper service court, it is a fault; if it touches the net and falls into the proper court, it is a "let"; if in the wrong court, it is a fault.

**LAW 33** It is a fault if the ball served do not drop as provided in Law 32, or if it touch the server's partner or anything he wears or carries.

**Explanation of Law 33.**

It makes no difference where the ball goes after it touches a player. If this happens during a service, it is a fault; during a rally, the ball is dead and the player who is hit loses the point.

**Cases and Decisions.**

*Case 1*—The server's first service strikes his partner. Does he lose the stroke or is it a fault?

*Decision*—A fault.—James Dwight.

## How to Lay Out a Tennis Court

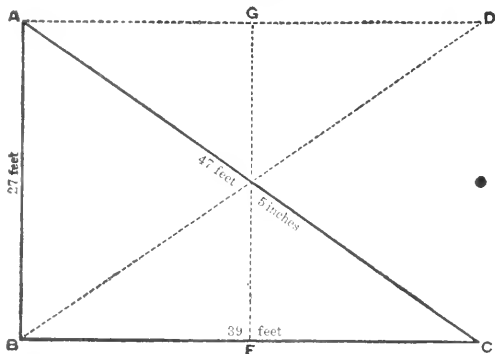

As a double court practically includes every line to be found in a single court, it is best to take first the measurements for the latter. Having determined the position of your net, plant in the ground in the line chosen, two pegs 27 feet apart (at the points A and B in the diagram). Then take two measures and attach their respective ends to the pegs A and B. On the first, which will measure the diagonal of the court take a length of 47 feet 3 inches; on the other 39 feet pull both taut in such directions that at these distance they meet in a point C. This will give one corner of the court. At that point F, 21

feet from B, put in a peg to mark the end of the service-line. The other corner, D, and the other end of the service-line G, may be found by interchanging the measures and repeating the process. The same measurements on the other side of the net will complete the exterior boundaries of the court. By prolonging the base-line 4 feet 6 inches in each direction, and joining the four new points thus obtained, we can make the side-lines of a double court. It only remains to mark the central line. This is done by joining the middle points of the service-lines. If a double court alone be required, the interior side-lines need not be prolonged to meet the base-lines. Remember that in all cases the net-posts must stand at a distance of three feet from the side-lines.

For a court where a single or double game can be played, the size is 78 feet in length by 36 in width.  $4\frac{1}{2}$  feet inside the side lines, and parallel with them are drawn the service lines.

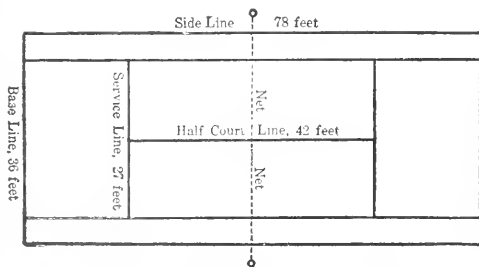

Diagram of Single and Double Court



## How to Build and Keep a Court

Nothing is more important for the full enjoyment of lawn tennis than a satisfactory court, and none of the other accessories of the game offers a wider variety. Many important considerations come up even after the kind of court to be built, and the cost, have been decided upon. No matter how much is to be spent on the ground, nor what the surface is to be, the most important things to consider first are space, light and drainage.

The back-stop nettings should never be nearer than fifteen feet to the lines, and if good players are expected to use the court, particularly if tournament matches are to take place on it, the space behind the base-line should be 21 feet at each end. At the sides at least 6 feet, if possible 12 feet should be allowed beyond the side-lines for doubles of each court. A well-appointed court for tournament play should be centered in an unobstructed space of not less than 60 x 120 feet. Wire back-stop netting 10 or 12 feet high should surround it at these distances from the lines. If there are two or more courts together, there should be at least 12 feet between their side lines, and one netting can surround all.

In selecting a site for a court, a spot should be chosen where there is always plenty of sunlight, and where at no time of the day does any shadow cross the ground on which the court is to be laid. Green or black is a preferable background to play against, but any dark and even color will do. A court should never be laid out with any very light background within a short distance at either end, or close at either side. Nor should a site be selected with a badly mixed or moving background. Shade trees are useful near a court, only if their shadow is a solid one, not constantly checkered by flecks of sunlight glittering through moving branches, which constantly confuse the players. Never should they be allowed near enough to cast any shadows on the playing surface.

One more cardinal point should be remembered. The court should invariably be laid out north and south—never east and west. If this warning is disregarded, the player at one end or the other will be hopelessly blinded by the sun.

The question of drainage is one of the most important considerations in selecting a site of this kind. On the natural facilities depends largely the cost of laying out a good court. If the natural soil be sandy and well drained, or if it is on high ground which slopes away near by, artificial drain pipes will not have to be put in, and this saves much of the cost, but if it be thick clay that holds moisture long, or on low ground with neighboring slopes that drain toward it, the court will be useless for many hours after each rainfall unless artificial drain-pipes are put in.

After the site has been selected, it must be decided whether a grass or "dirt" court is to be built. If the natural sod is luxuriant and the soil favorable for its growth, or if the court is not to be used enough to wear off the grass, a turf court will generally be found preferable, but if the ground is to be constantly in use, the sod will wear off and become "bald" unless there is space enough on the lawn to shift the court frequently.

When good turf cannot be had or will not stand the wear, a substitute must be found, and sand or dirt courts are most often used. On well-drained land, one can sometimes cut away the top surface, level the ground and roll it until well hardened and the court is ready for use, but more preparation is necessary to build a permanent court that will not be constantly losing its proper level.

For such a court the earth should be cut away to a depth of one foot if no drains are required. After leveling it carefully with a spirit-level, to be sure that the grade is right, a layer of six inches of broken stone should first be laid and pounded down hard. Ordinary trap-rock used for macadamizing roads is perhaps the best for this purpose, but any broken stone, ranging in sizes from a walnut to an egg, will answer

the purpose. This should be covered with a three-inch layer of coarse gravel or fine broken stone, which should be thoroughly pounded and watered for several days before being covered. Before any surface is put on the court, the greatest care should be taken to see that the foundation is perfectly level. Any holes or depressions that appear from rolling and pounding should be filled in before it is covered.

Every well built court should be graded either from end to end or from side to side to an extent of not over two inches, which will suffice to drain off rain water. If artificial drainage is necessary to keep the court dry, drain pipes can be laid in the foundations of the court about three feet outside the side and end lines, care being taken whereby the pipes will tilt, following the grade of the court as far as possible, thus allowing the water to run off. The best drain pipes are six-inch stone sewer pipe, cut in halves, or stone gutters used on tiled roofs, which should be sunk in the ground immediately under the foundation of broken rock and filled with pebbles or fine cragged stone.

The covering for a gravel or sand court should be not less than three nor more than six inches in thickness, and of sandy loam and clay mixed. The proportions depend on the quality of the clay. If it is very binding and sticky, one part of sand to four of clay are preferable, but for the average ingredients they should be mixed about eight parts of clay to one part of sand. When the court is finished, if it is found to be too soft but dry, more clay should be added; while if it drains poorly and stays muddy too long after rain, or its surface is too sticky for the player's feet, more sand should be added on the surface. When a court is finally covered, it should be thoroughly watered and rolled alternately twice every day for two weeks before it is played on at all, and any depressions or uneven spots corrected as fast as they appear from the settling. After the first heavy rain storm it should be gone over and leveled most carefully, for then it is most likely to develop new faults.

The fine seashore sand will seldom be found satisfactory for the surface of a court, for it works loose too quickly under the players' feet, and can only be made to bind when mixed with a larger proportion of clay, which will make the drainage more difficult, as water percolates very slowly through clay. If the soil upon which a court is being built is very rich and worms promise to work through to the surface above and injure the court, it is well to lay a layer of fine cinders, those from a railroad engine preferred, between the foundation and the sandy surface layer. These cinders effectually prevent worms from coming through to the surface. It is also well to use coarse sifted ashes mixed with the stones in the drain-pipes.

The construction of a grass court is less difficult, but varies much more in process. If cost need not be considered, it should be built by an expert, and will be laid on deep-laid foundations; if it is desired to build an economical court on an available lawn which is fairly level, the cost will not be heavy. The sod should first be carefully removed in squares of about eighteen inches, from a space at least 50 by 100 feet, cutting down to a depth of about six inches. The ground should then be turned with a spade to a depth of eighteen inches or two feet, and after all stones have been removed, and the earth carefully raked over and leveled, it should be packed and rolled with a heavy roller. It cannot have too much leveling and rolling, and the rolling should be kept up for several days with plenty of soaking by rain or hose-pipe. Any inequalities which the heavy pressure of the roller produces should be filled in or cut down before the sods are relaid.

After the ground has been rolled sufficiently the sods should be replaced. In doing this it is important to get the edges close together, so that no seams or open cracks can be found. These sods should be relaid in the afternoon and well drenched with water. The next day the ground should be rolled again; and this should be followed by alternate drenching and rolling for several days. Even when the ground finally appears firm and level, the court should not be played

upon until new blades of grass appear in considerable numbers. If depressions appear, the sod at that spot should be lifted, fresh earth inserted to the proper grade and the sod replaced, watered and rolled till level and flat again.

Bad spots are often found where the grass is thin or where malignant weeds obstruct its growth, and in this case fresh sods should be bought or cut elsewhere and substituted. Sometimes large patches of ground must be renewed in this way, but it will be found much less expensive if all the turf is bad to sow the new court down with lawn seeds, and seeds will often help out thin spots in the grass if the court is not to be used too soon after the sowing. It is better to make a grass court in the fall whether it is to be sown with seed or sodded. The winter storms will then settle it thoroughly, and after a little releveling in the spring it will be ready for use.

Grass seeds should be sown between the middle of March and the first of May, or better yet, in the autumn, between the middle of August and the first of October. It takes about 20 pecks of good lawn seed to cover a space 60 by 120 feet. The sowing should be gone over twice, the second time at right angles to the first. Clover seeds should be avoided, as this grass does not wear well, and guano should not be used for fertilizing, for it tends to bring up coarse blades in patches.

As soon as the young grass is high enough to be topped, a scythe or sickle should be used, being at first better than the mowing machine. After the new grass is well hardened, however, the latter should be constantly in use, never less than once a week, and in moist warm weather nearly every day. With every precaution weeds are sure to appear, but these can generally be held in check by constant mowing. The more formidable weeds, however, must be cut with a knife one by one about an inch below the surface, and care being taken to remove as much of the root as possible. A pinch of salt dropped on the cut root will generally stop the growth. When the turf becomes worn in spots a small shift in the lines of the court will relieve the pressure and enable the grass to grow again; at the end of the season all of the bare patches should be resown.

Once the court is finally built and ready for use, it must be properly marked out. In every case, unless it be of grass, and the lines are to be constantly shifted to prevent bare spots, net-posts should be permanently sunk in the ground. They should be not less than two feet under the ground nor less than forty feet apart.

A good dirt court should be swept, watered, rolled and freshly marked out after every eight or ten sets of play, and oftener in very dry weather. Instantly a depression is discovered it should be filled in and rolled down before playing is continued, for it is almost as dangerous for the players as the court to continue with it uneven. A court should never be rolled in the condition the players leave it after play. A player's heel raises a little lump; if the roller goes over this before it is swept down even again, a hard ridge results and the ball will bound unevenly from it. It should be swept over first, until all the lumps are leveled down, before the roller is allowed on its surface.

One of the best sweepers is made of a heavy joist of wood with a dozen thicknesses of old jute bagging or coarse cloth frayed out at the bottom edges, fastened to its bottom and trailing on behind it. This should be drawn over the court with a handle or rope several times. If it is pushed, the groundsman's feet will leave tracks after it; if he goes ahead the sweeper will erase them. Before the lines are marked out fresh, the old ones should always be swept off with a broom, but if the broom is constantly used along the lines in a parallel direction, it will gradually wear away little grooves in the court where the lines are and the balls will bound improperly from them. The sweeping should be done lightly across the court, at right angles with the lines.

A grass court cannot have too much care. It is advisable to wet it thoroughly several times a week and roll it as often. It should be

watered at night, cut in the morning, and rolled after cutting and before watering. The best way to repair a bare strip of ground is to lay fresh turf, and this should be done in the fall or as early as possible in the spring. Good tough turf, laid in February or early in March, will be fit for use by the first of June. In the early spring grass roots both in new turf and old may be greatly benefited by a good dressing of manure well worked in, but regular manuring should also be done in the fall.

Worm casts are very bad for good tennis turf. Particularly in fertile ground or after a storm, the little mounds will appear on the sod, and if the roller passes over them or they are trodden down little hard lumps are formed which spoil the surface of the court. The turf should always be swept before rolling, and in rich soil every morning. This scatters the mounds effectually. Where it is necessary to get rid of the worms, lime water should be sprinkled on the ground. They will then come to the surface and can be swept away.

When a horse mowing machine is used it is well to have the horse's hoofs covered with soft pads to prevent their cutting into the turf and leaving prints that affect the bound of the ball. The groundsman at work on good lawn tennis courts, particularly when the turf is soft, and always on a sand court, should be required to wear rubber-soled shoes without heels.

Of the various other kinds of courts, namely, asphalt, concrete, cinder, etc., the asphalt is probably the better type.

The asphalt court is very hard and fast, giving the ball a much higher bound than any clay or gravel court. Hence it has placed an additional premium on swift serving, smashing and volleying. Aggressiveness—that quality which is absolutely essential for first string champions—has therefore become part and parcel of the game in California. Asphalt makes the attacking game *imperative*.

Although the asphalt court lacks many of the attractions of the best turf and clay courts (being so very hard), it has its advantages. If it is properly constructed, the cost of its upkeep is practically *nil* compared to others. Aside from freshening up the lines with paint once a year and sweeping it free from dust and litter occasionally, there is no expense of cash or effort necessary. Then, too, it can be dried with brooms and mops within an hour or less after the hardest rain. In Eastern climates snow could readily be shoveled and swept off, and the spring thaw would never feaze it. Furthermore, the asphaltum surface is perfectly true. No bad bounds, except on ancient and poorly built courts.

The Fay Improvement Company of San Francisco, the leading court builders on the Coast, have kindly supplied the following specifications for the benefit of those who wish to install asphalt courts:

"The area of the court should be 60 x 120 feet. The ground should be graded so as to have a pitch of at least 9 inches in 120 feet without any crown whatsoever. The subgrade should be either rolled with a small steam roller weighing two and one-half tons, or with heavy hand rollers. Upon your subgrade place four inches of concrete, or if you can obtain good bedrock macadam, six inches of that will serve instead. Upon this, spread one inch of asphalt wearing surface, which should be made of the following proportions: Asphalt having a penetration of 70 to 90 degrees, 120 pounds; powdered limestone or cement, 150 pounds; fine sand, possessing not over three per cent loam or mica, 745 pounds. The foregoing quantities constitute nine cubic feet of finishing material, covering an area of *one hundred feet square* and one inch thick. Particular pains should be taken in ironing and hand rolling of the asphalt so that there will be no roughness after the final rolling. There should be two hand rollers used when the asphalt is spread, one weighing about 600 pounds, followed by a lighter one weighing close to 400 pounds. The rakers should work to a three-quarter inch surface board in spreading the material. Should the subgrade be all loam or material that opens up and cracks, it would be good to spread about two inches of sand before the concrete base or macadam is laid."

Concrete courts should be laid in blocks, and have a possible advantage over asphalt in a very hot climate, as they will not get soft and spongy. The building of a concrete court should in most cases be left to a first-class contractor.

Cinder courts are cheap and easy to construct, but have the disadvantage of being very dirty.

In regard to wood courts, which are becoming quite popular, the best plan to follow would be to consult an expert court builder. Hemlock and Louisiana cypress are usually the two best kinds of wood to use. The life of a wood court is usually from five to ten years.

#### BOARD COURTS.

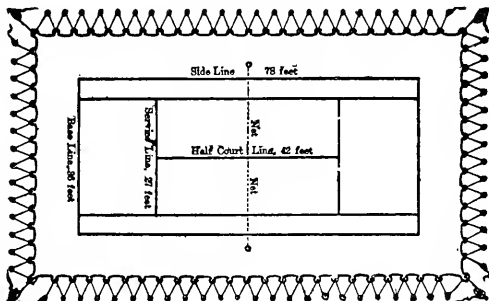

In regard to board courts, it is in the first place essential that they should be firm and yet springy and made as near the ground, if out of doors (which seems to be the popular method at the present time), as possible. The foundation of a wooden court should be of heavy beams, sufficiently so to prevent all bending or giving. The boards laid on same should be not less than  $1\frac{1}{2}$  inch in thickness in order to obtain the best results, and if a wooden playing surface is desired, the boards should be laid  $\frac{1}{8}$  inch apart, which will permit rapid drainage, and after having been laid, same should be painted green with white marking lines. The best playing surface is secured by having a flap of heavy canvas made by a sailmaker, which will be of sufficient size to not only cover the court, but also extend at least 10 feet outside the boundaries of same. This canvas should be stretched by method of rope passing through eyelets, with pulleys at each corner of the court, by means of which the rope can be constantly kept tight. After the canvas has been laid and properly stretched, it should be painted a grass green, upon which white marking lines  $1\frac{1}{2}$  inch in width can be made. A canvas covering such as this is of some considerable expense, but with proper care, that is, painting same sufficiently often during the winter season and storing same carefully during the hot months, it should last for some years. Wooden courts for inside play, that is, covered courts, should be laid whenever possible on wooden beams, so as to get some slight spring, and not on iron or concrete, which will render them so dead as to make it exceedingly hard for the players' feet.

ACCEPT NO  
SUBSTITUTE

THE SPALDING



TRADE-MARK

GUARANTEES  
QUALITY

## SPALDING 1919 "AUTOGRAPH" RACKETS

*A. J. Spalding & Bros.*

This Autograph Signature on an Athletic Article Means Highest Satisfaction

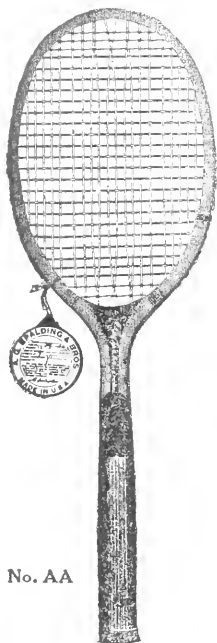

No. AA

No. AA. Black trim, including depressed throat piece, and rawhide reinforcement inside and out at bend, and gut throat winding. Full bow frame, no bevel. Four sided all cedar handle, either 5, 5 $\frac{1}{4}$  or 5 $\frac{3}{8}$  inches in circumference. Special expert stringing of best quality Spalding Autograph gut. Without cover.

Each, \$12.00

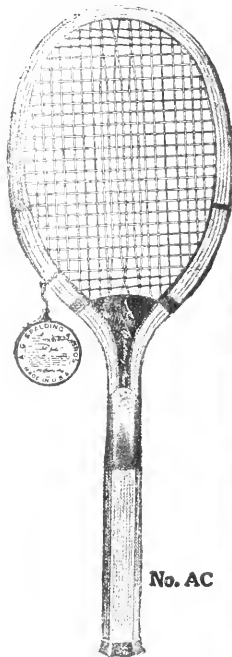

No. AC

No. AC. Brown trim, including regular throat piece, rawhide reinforcement inside and out at bend, and gut throat winding. Frame has special shaped bevel. Four sided all cedar handle, either 5, 5 $\frac{1}{4}$  or 5 $\frac{3}{8}$  inches in circumference. Special expert stringing of best quality Spalding Autograph gut. Without cover.

Each, \$12.00

KEEP RACKET IN A DRY PLACE, OTHERWISE THIS GUARANTEE IS VOID

**GUARANTEE** We Guarantee Lawn Tennis Rackets for a period of 30 days from date of purchase by the user. The Guarantee Tag attached to each Spalding Lawn Tennis Racket reads as follows: If this Racket proves defective in workmanship or material within 30 days from date of purchase, please return, transportation charges prepaid to any Spalding Store, and the defect will be rectified. Imperfectly strung Rackets will be restrung, and in the event of a broken frame due to workmanship or defective material, the Racket will be replaced. NOTICE—This Guarantee does not apply to Rackets weighing less than 13 ounces, nor unless Racket is kept in a press.

We urge that at the conclusion of play Racket be rubbed dry, and when not in use be covered with a Waterproof Cover, placed in a Racket Press, and the gut occasionally gone over with Spalding Tennis Gut Preservative.

PROMPT ATTENTION GIVEN TO  
ANY COMMUNICATIONS  
ADDRESSED TO US

A. J. SPALDING & BROS.  
STORES IN ALL THE COUNTRIES

FOR COMPLETE LIST OF STORES  
SEE INSIDE FRONT COVER  
OF THIS BOOK

PRICES SUBJECT TO CHANGE WITHOUT NOTICE. For Canadian prices see special Canadian Catalogue

ACCEPT NO  
SUBSTITUTE

THE SPALDING



TRADE MARK

GUARANTEES  
QUALITY

## SPALDING CHAMPIONSHIP TENNIS RACKETS

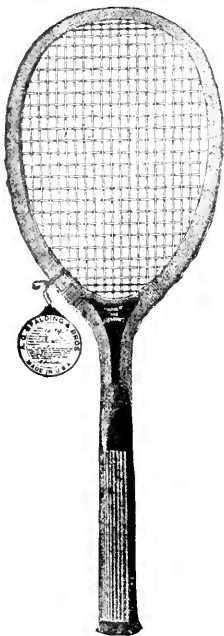

No HA

The National Men's Championship was won with a Spalding Hackett & Alexander Racket, (No. HA as listed below) used by and named for these famous players.

The National Women's Championship was won with a Molla Bjurstedt Racket, (No. MB as listed below) made by us under special direction of this great Norwegian player.

### SPALDING HACKETT & ALEXANDER MODEL HA

No. HA. Has depressed throat piece, rawhide reinforcements inside and out at bend, supplemented with gut throat winding. It has a full bow frame, no bevel. The handles are four-sided, all cedar, either 5, 5 $\frac{1}{4}$  or 5 $\frac{3}{8}$  inches in circumference. The stringing is of best quality Spalding Autograph gut, by our most expert stringers. Without cover.

Each, \$12.00

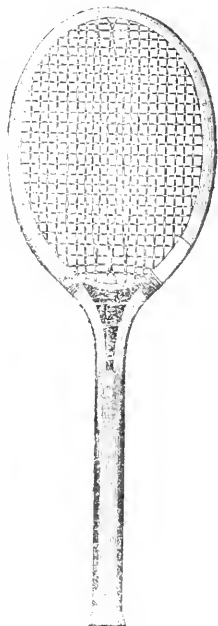

No. MB

### "MOLLA BJURSTEDT" AUTOGRAPH MODEL MB

No. MB. Built with depressed throat piece, gut throat winding. Full bow frame, no bevel. The handle is of cedar, four-sided, with small size grip. Weight 13 $\frac{1}{4}$  ounces and slightly over or under. It is made specially for women and is identically the same model as used for the past two seasons by this famous woman champion, Miss Molla Bjurstedt. Best Spalding Autograph gut only is used, strung as are other Spalding highest grade rackets, by our most expert stringers. Without cover. . . . . Each, \$12.00

In the complete Spalding tennis line is a racket to suit the requirements of every kind of player.

PROMPT ATTENTION GIVEN TO  
ANY COMMUNICATIONS  
ADDRESSED TO US.

**A. G. SPALDING & BROS.**  
STORES IN ALL LARGE CITIES

FOR COMPLETE LIST OF STORES  
SEE INSIDE FRONT COVER  
OF THIS BOOK

PRICES SUBJECT TO CHANGE WITHOUT NOTICE. For Canadian prices see special Canadian Catalogue

ACCEPT NO  
SUBSTITUTE

THE SPALDING



TRADE-MARK

GUARANTEES  
QUALITY

# SPALDING "GOLD MEDAL" TENNIS RACKETS

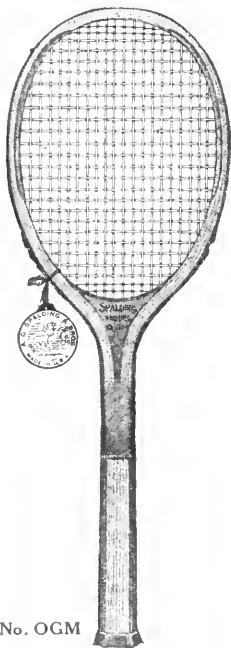

No. OGM

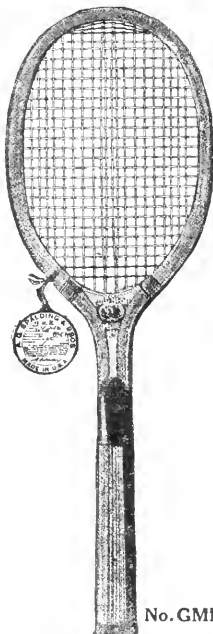

No. GMH



No. GMF

## SPALDING No. OGM MODEL

Walnut depressed throat piece, rawhide reinforcement inside, gut wrapped shoulders, Handles, 5, 5 1-4, and 5 3-8 inches in circumference.

No. OGM. Strung with best lambs' gut. Four sided cedar handle. Without cover. Ea., \$10.00

## SPALDING "GOLD MEDAL" MODEL H

Reg. U. S. Pat. Off.

White holly depressed throat piece, rawhide reinforcement inside and outside, and gut wound shoulders. Handles, 5, 5 1-4 and 5 3-8 inches in circumference. The stringing is double in the central portion in the popular expert style.

No. GMH. Strung with best lambs' gut. Four sided cedar handle. Without cover. Ea., \$10.00

## SPALDING "ALL COMERS" RACKET

Reg. U. S. Pat. Off. Feb. 20, 1912

Patented January 3, 1905; June 12, 1906

Walnut throat piece; shoulders gut wrapped and with special side reinforcement of rawhide. Stringing is double in the central portion, in the latest expert style. Handles, 5, 5 1-4 and 5 3-8 inches in circumference.

No. GMF. Strung with best lambs' gut. Four sided cedar handle. Without cover. Ea., \$10.00

**GUARANTEE** We Guarantee Lawn Tennis Rackets for a period of 30 days from date of purchase by the user. The Guarantee Tag attached to each Spalding Lawn Tennis Racket reads as follows: If this Racket proves defective in workmanship or material within 30 days from date of purchase, please return, transportation charges prepaid, to any Spalding Store, and the defect will be rectified. Imperfectly strung Rackets will be restrung, and in the event of a broken frame due to workmanship or defective material, the Racket will be replaced.

NOTICE—This Guarantee does not apply to Rackets weighing less than 13 ounces, nor unless Racket is kept in a press.

KEEP RACKET IN DRY PLACE, OTHERWISE THIS GUARANTEE IS VOID.

PROMPT ATTENTION GIVEN TO  
ANY COMMUNICATIONS  
ADDRESSED TO US

**A. G. SPALDING & BROS.**  
STORES IN ALL LARGE CITIES

FOR COMPLETE LIST OF STORES  
SEE INSIDE FRONT COVER  
OF THIS BOOK

PRICES SUBJECT TO CHANGE WITHOUT NOTICE. For Canadian prices see special Canadian Catalogue.





SPALDING "FAMOUS MODEL" TENNIS RACKETS

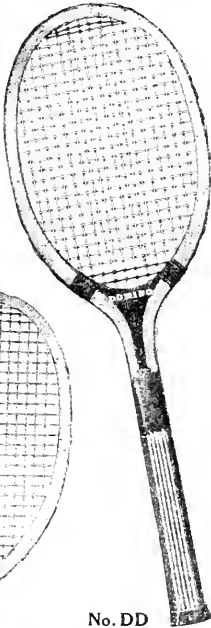

No. DD

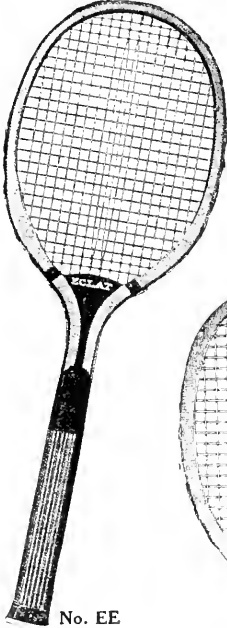

No. EE



No. GX

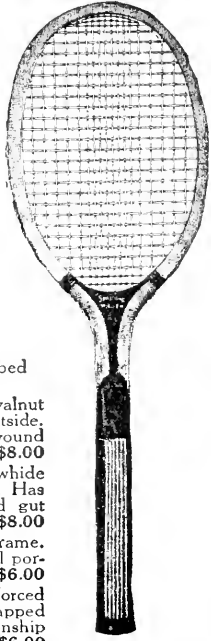

No. EH

Frames of finest white ash, highly polished; combed Spanish cedar handle, leather capped.

**Spalding "Domino" Model DD.** Depressed walnut throat, with rawhide reinforcement inside and outside. Double stringing in central portion. Gut wound shoulders. Selected gut stringing. . . . Each, \$8.00

**Spalding "Eclat" Model EE.** Walnut throat, rawhide reinforcement outside. Gut wrapped shoulders. Has double stringing in central portion. Selected gut stringing. . . . . Each, \$8.00

**Model GX.** Gold Medal shape. Oak reinforced frame. Stringing of good quality gut, double in central portion in the popular expert style. . . . Each, \$6.00

**Model EH.** Depressed walnut throat, oak reinforced frame. Selected gut stringing. Shoulders wrapped with gut. Recommended except for championship tournament play. . . . . Each, \$6.00

PROMPT ATTENTION GIVEN TO ANY COMMUNICATIONS ADDRESSED TO US

**A. G. SPALDING & BROS.**  
STORES IN ALL LARGE CITIES

FOR COMPLETE LIST OF STORES SEE INSIDE FRONT COVER OF THIS BOOK

# SPALDING "TRADE MARK" TENNIS RACKETS

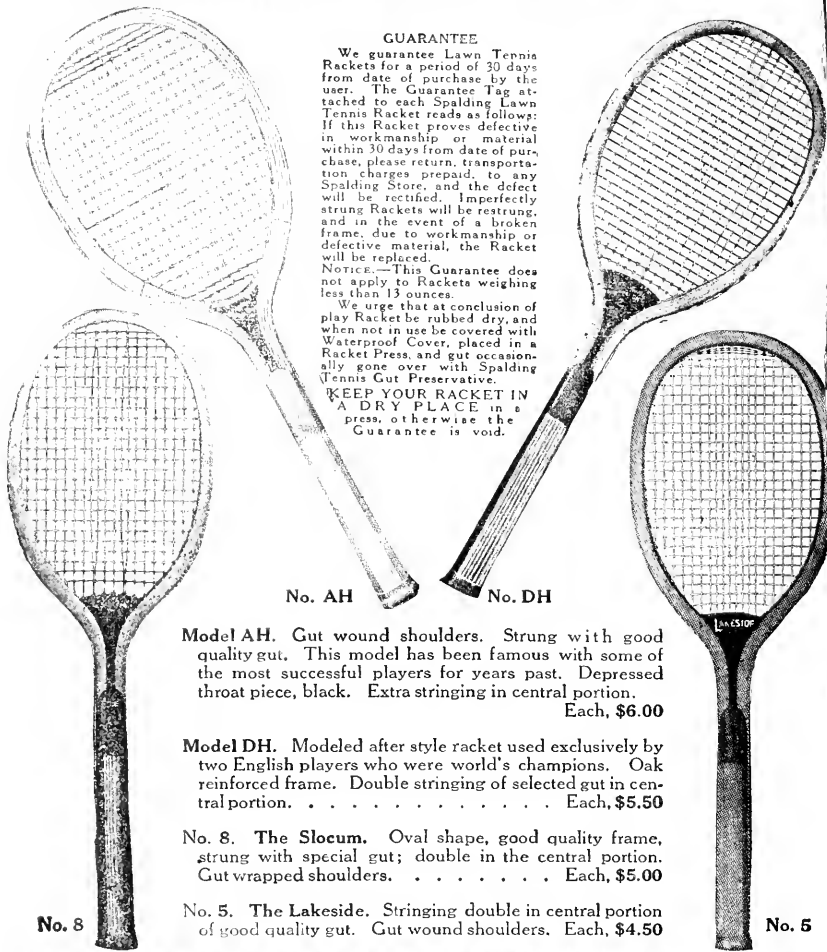

**GUARANTEE**

We guarantee Lawn Tennis Rackets for a period of 30 days from date of purchase by the user. The Guarantee Tag attached to each Spalding Lawn Tennis Racket reads as follows: If this Racket proves defective in workmanship or material within 30 days from date of purchase, please return, transportation charges prepaid, to any Spalding Store, and the defect will be rectified. Imperfectly strung Rackets will be restrung, and in the event of a broken frame, due to workmanship or defective material, the Racket will be replaced.

Notice.—This Guarantee does not apply to Rackets weighing less than 13 ounces.

We urge that at conclusion of play Racket be rubbed dry, and when not in use be covered with Waterproof Cover, placed in a Racket Press, and gut occasionally gone over with Spalding Tennis Gut Preservative.

**KEEP YOUR RACKET IN A DRY PLACE in a press, otherwise the Guarantee is void.**

No. AH

No. DH

**Model AH.** Gut wound shoulders. Strung with good quality gut. This model has been famous with some of the most successful players for years past. Depressed throat piece, black. Extra stringing in central portion.

Each, \$6.00

**Model DH.** Modeled after style racket used exclusively by two English players who were world's champions. Oak reinforced frame. Double stringing of selected gut in central portion. . . . . Each, \$5.50

**No. 8. The Slocum.** Oval shape, good quality frame, strung with special gut; double in the central portion. Gut wrapped shoulders. . . . . Each, \$5.00

**No. 5. The Lakeside.** Stringing double in central portion of good quality gut. Gut wound shoulders. Each, \$4.50

No. 8

No. 5

PROMPT ATTENTION GIVEN TO ANY COMMUNICATIONS ADDRESSED TO US

**A G SPALDING & BROS.**  
STORES IN ALL LARGE CITIES

FOR COMPLETE LIST OF STORES SEE INSIDE FRONT COVER OF THIS BOOK

ACCEPT NO  
SUBSTITUTE

THE SPALDING



TRADE-MARK

GUARANTEES  
QUALITY

# SPALDING "TRADE MARK" TENNIS RACKETS

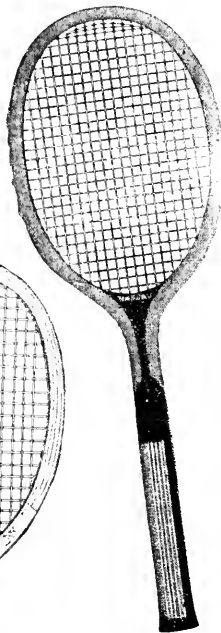

No. 6

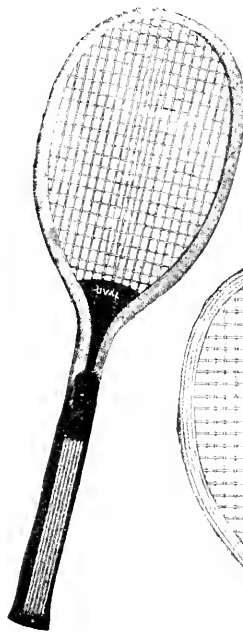

No. 7

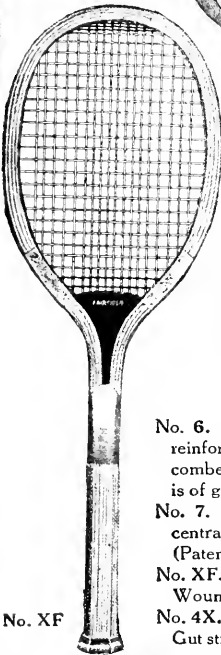

No. XF



No. 4X

- No. 6. **The Nassau.** Black depressed throat with oak reinforcement. Frame of white ash, highly polished, with combed Spanish cedar handle, leather capped. Stringing is of good quality gut. (Reg. U. S. Pat. Off.). Ea., \$4.50
- No. 7. **The Oval.** Oval shape, with extra stringing in central portion; good quality gut. Gut wound shoulders. (Patented Jan. 3, 1905). . . . . Each, \$4.00
- No. XF. **Fairfield.** Black throat. Frame of selected ash. Wound shoulders. Good quality gut strung. Each, \$3.50
- No. 4X. **Ace.** Depressed throat. Frame of selected ash. Gut strung double in central portion. . . . Each, \$3.00

PROMPT ATTENTION GIVEN TO  
ANY COMMUNICATIONS  
ADDRESSED TO US

**A. G. SPALDING & BROS.**  
STORES IN ALL LARGE CITIES

FOR COMPLETE LIST OF STORES  
SEE INSIDE FRONT COVER  
OF THIS BOOK

PRICES SUBJECT TO CHANGE WITHOUT NOTICE. For Canadian prices see special Canadian Catalogue

ACCEPT NO  
SUBSTITUTE

THE SPALDING



TRADE-MARK

GUARANTEES  
QUALITY

### SPALDING TENNIS NETS

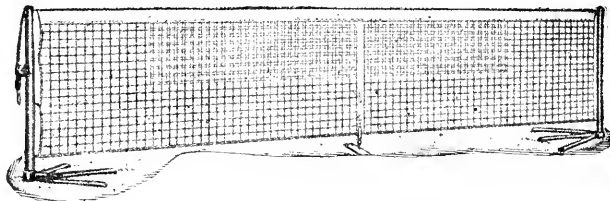

#### Spalding "Championship" Tarred Nets—Hand Made

For tournament play. With extra heavy galvanized wire cable. Extra heavy duck binding at top  
No. 10-0. 42½ ft. x 3¼ ft., 48 thread. Each, \$24.00 No. 9-0. 42½ ft. x 3¼ ft., 30 thread, Each, \$18.00  
No. 8-0. 33 ft. x 3¼ ft., 30 thread. Each, \$16.00

Spalding Tarred Nets, Hand Made; Bound with 10-oz. Duck at Top, with Heavy Tarred Top Rope  
No. 7-0. 42½ feet x 3¼ feet, 21 thread. . . . . Each, \$16.00

#### Spalding Double Center Nets—Hand Made

Double Twine knitted together from 20 to 26 feet. White, 21 thread, Double Court.  
No. 3D. 42 ft. x 3 ft., double center 26 ft. \$12.00 No. 2D. 36 ft. x 3 ft., double center 20 ft. \$10.00

#### Spalding Canvas Bound Nets—Hand Made

NOT Double Center. Top bound with heavy 2-inch canvas strip. Double Court  
No. 3B. 42 ft. x 3 ft., 21 thread, white. \$10.00 No. 2B. 36 ft. x 3 ft., 21 thread, white. \$8.00

#### Spalding Hand Finished Nets

No. IX. Single court, 27 ft., 12 thread, bound with ¼-inch Manila rope. . . . . Each, \$3.00

For Double Court, Top bound with heavy 2-inch canvas strip. (White)

No. 5AX. 42 feet, 21 thread, tarred. Ea., \$10.00 No. 4AX. 42 feet, 21 thread. . . . . Each, \$7.50  
No. 3AX. 42 feet, 15 thread. . . . . Each, \$6.00

For Double Court, Top and bottom bound with heavy cotton rope. (White)

No. 3X. 42 feet, 15 thread. . . . . Each, \$4.50 No. 2X. 36 feet, 15 thread. . . . . Each, \$3.50

#### Spalding Twine Nets for Backstops—Machine Made

No. 4X. White, 50 feet long, 7 feet high, 9 thread. . . . . Each, \$8.00  
No. 5XT. Tarred, 50 feet long, 8 feet high, 12 thread. . . . . " 11.00

#### Galvanized Steel Cable for Top Cords

Full length ¼-inch galvanized steel cable, five strands of seven wires each, twisted tightly. With metal loop at each end and manila rope ends to fasten to posts. . . . . Each, \$3.00

#### Canvas Center Straps for Holding Center of Net at Regulation Height

No. 2-0. Does not chafe net, and cannot possibly cause the ball to glance off and strike out of court. . . . . Each, \$1.60  
No. 3-0. Tournament Pattern, same as No. 2-0, except fitted with a turn-buckle, with which height of net can be adjusted to a hair. . . . . Each, \$2.00

#### Iron Center Forks

No. 2. Good quality iron fork. . . . . Each, \$2.00

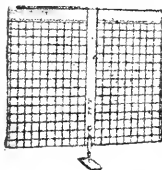

No. 3-0

PROMPT ATTENTION GIVEN TO  
ANY COMMUNICATIONS  
ADDRESSED TO US

**A. G. SPALDING & BROS.**  
STORES IN ALL LARGE CITIES

FOR COMPLETE LIST OF STORES  
SEE INSIDE FRONT COVER  
OF THIS BOOK

PRICES SUBJECT TO CHANGE WITHOUT NOTICE. For Canadian prices see special Canadian Catalogue.

(Established 1907)

# AMERICAN LAWN TENNIS

S. W. MERRIHEW, Editor and Proprietor

Official Organ United States National  
Lawn Tennis Association

If you play tennis, or are interested in it, you cannot afford *not* to read American Lawn Tennis. It covers every phase of the game, describes and illustrates all tournaments, tells all about the players of prominence, and publishes valuable and interesting articles on match play, strategy and tactics, production of strokes, etc.

|                       |        |
|-----------------------|--------|
| Seven issues . . . .  | \$1.50 |
| One Year (15 issues)  | 3.00   |
| Three Years . . . .   | 7.75   |
| Six Years . . . .     | 14.50  |
| Life (transferable) . | 35.00  |

Published on the 15th of every month, and on July 1,  
August 1 and September 1

AMERICAN LAWN TENNIS  
120 Broadway, New York

## The New Spalding "Official" Two-Piece Tennis Ball

Tennis players for many years have realized that the balls in use had certain mechanical defects which seemed unsurmountable, especially as the work on the balls, to a great extent, was done by hand and therefore subject to all the variations to which the human element is susceptible.

The old method necessitated the sticking onto the wall of the ball of a plug or valve. This plug was put on to the ball to permit of an air needle being inserted through it, and the ball itself inflated after moulding. Very often this needle hole leaked slowly and the ball gradually lost its life. Occasionally, also, in spite of careful manipulation, the plugs became loosened and the ball would rattle and quickly deflate.

It is with great pleasure therefore that A. G. Spalding & Bros. have announced that at last, after much experimenting, they have been able to manufacture a tennis ball which eliminates the troubles that have beset players for so long. In the first place, instead of the old method of making the ball in four pieces, the new ball is a two-piece affair. The work is exclusively done by machine, the result being that one ball is precisely like another, even the walls not varying a thousandth of an inch. These two pieces are put together automatically and the ball inflated in the process before being vulcanized. This process necessitates only one seam and eliminates the crude overlapping seams of the old method. The cover, which is made of the finest Australian wool, is cemented and sewn on, giving permanent adhesion, which, together with the evenness of the wall, assures perfect flight and bound.

It needs no argument to show that the plug makes an unbalanced ball, while on the contrary, in the two-piece ball, there is *perfect uniformity and perfect balance*.

It is the "everyday" player who is the backbone of tennis in America. Often tennis is his sole means of recreation. With the Spalding two-piece ball he will obtain greater accuracy with less effort, while its durability will be an important factor in lessening frequency of replacement—emphasizing the economy of quality.

Scientific tests, supplemented by use in actual contests, have proven the remarkable qualities of the Spalding two-piece ball, and it will undoubtedly effect as much an improvement in tennis as the Spalding cork center ball has done for base ball and similar Spalding achievements in golf ball construction.

Aside from the improved methods of manufacture, an important feature of the Spalding two-piece ball will be the facility for supplying fresh balls through the medium of the Spalding stores and dealers located at all central points throughout the United States. Instead of making the balls in a batch months ahead, by the Spalding system of organization the factory is enabled to parallel the demand from any portion of the United States, with the assurance to the player that he will receive fresh balls throughout the season.

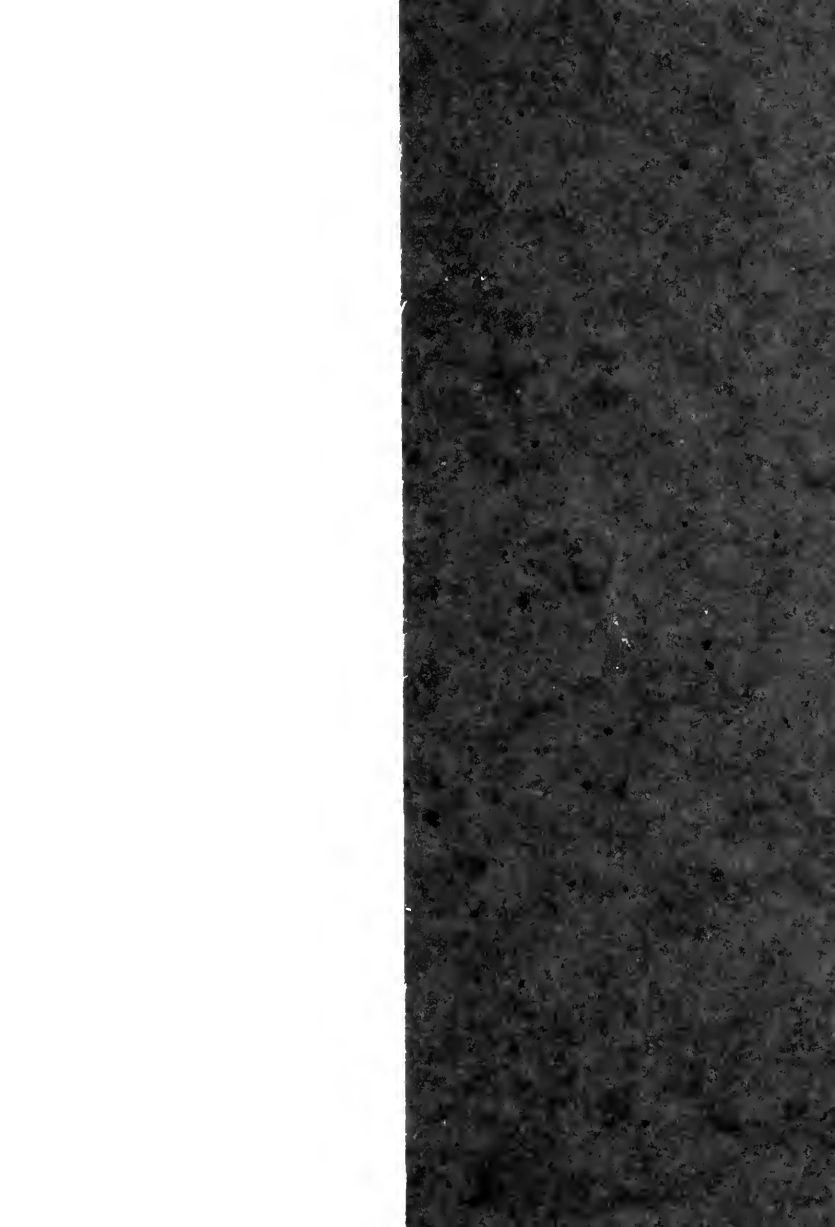

LIBRARY OF CONGRESS

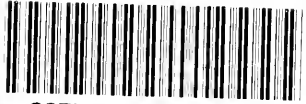

0 005 900 272 7